



FLEXIBLE HANGING SOLUTIONS

Artiteq[®]

PRODUCT CATALOGUE
2025

ARTITEQ.COM

▶ ABOUT ARTITEQ

Artiteq's smart, sustainable hanging and display systems transform every wall into a limitless canvas. For almost 35 years, our family business has inspired art connoisseurs, interior décor enthusiasts and companies around the world to give every space its own ambience and energy. Our solutions are both functional and stylish, whether you wish to create a cosy homely atmosphere, have artistic freedom, create an interior to guarantee maximum impact, or ensure effective routing.

In 1991 we took the first small step of our adventure, at home in the garage of founder Jan van Boxtel. Today we are active in more than 80 countries and sectors. You will find us in DIY stores, in the education and property remodelling sectors and in art galleries. Our product range now also includes window displays, display systems and signing hanging systems, always underpinned by quality, flexibility and creativity.

Our family culture ensures that everyone feels welcome and can rely on one another. This enables us to perform at the highest possible level, with continuous improvement. We work closely



Meet our company

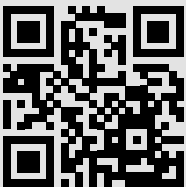

WWW.ARTITEQ.COM ◀

with distributors and dealers throughout the world, we support them with marketing, training and reliable deliveries and we focus on innovation and sustainability.

Sustainability and social return are our core values. Because we want to give something back. This is why we assemble locally along with the Diamant group, that offers sheltered employment to people who are disadvantaged in the labour market. Sustainability is a top priority when our products are being developed, with smart logistics and the use of recycled ocean plastic. We haven't yet achieved our ultimate goals, but continually take steps towards these.



MARKETING & SALES



IN-HOUSE RESEARCH & DEVELOPMENT



IN-HOUSE QUALITY CONTROL

PRODUCT CATEGORIES

OVERVIEW RAIL SYSTEMS 06

PICTURE HANGING SYSTEMS

WALL SYSTEMS 08

CEILING SYSTEMS 22

INTEGRATED SYSTEMS 28

FASTENER MATERIAL 40

SOLO SYSTEMS 42

ALL-IN-ONE KITS 54

HANGING WIRES AND HOOKS 60

FRAME ACCESSORIES 76

DISPLAY HANGING SYSTEMS

CABLE HANGING SYSTEMS 88

RAIL HANGING SYSTEMS 102

MISCELLANEOUS 114

SIGN HANGING SYSTEMS

SALES SUPPORT

ARTITEQ ONLINE

06

08

22

28

40

42

54

60

76

88

102

114

118

138

160



OVERVIEW RAIL SYSTEMS

















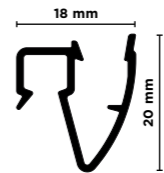
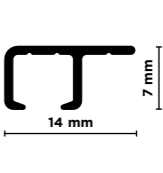



For every wall or interior there is a suitable hanging system to be found within Artiteq's range. When choosing a picture hanging system, there are several factors to consider. First, you need to determine where the system should and may be mounted, namely on the wall or on the ceiling. In addition, the stage of construction or interior plans and your personal taste and any specific requirements also play a role in the choice.











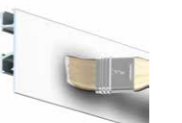

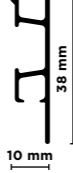

Each track system has maximum load capacity, design features, lengths and colour options. It is important to consider these aspects when making your choice. In this way, you can ensure that the hanging system perfectly suits your needs and aesthetic preferences.









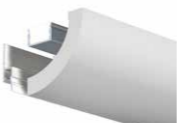

Below you will find an overview that clearly shows these features. This way, you can easily select the right hanging system to suit your specific situation.

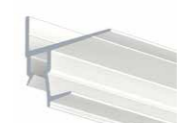
At Artiteq, we understand that every project is unique, which is why we offer a wide range of hanging solutions. Whether you are looking for a simple rail system for your artwork at home, or a more advanced system for professional use, we have the right solution for you.

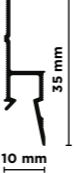
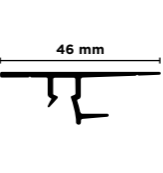
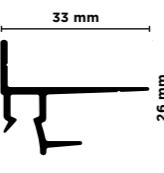

					
	CLASSIC RAIL	CLASSIC RAIL +	UP RAIL	TOP RAIL	DECO RAIL
WEIGHT CAPACITY (PER METER)	MAX. 20 kg	MAX. 40 kg	MAX. 20 kg	MAX. 20 kg	MAX. 20 kg
SIZE RAIL					
INSTALLATION	WALL	WALL	CEILING	CEILING, DROP CEILING	WALL, FLUSH AGAINST CEILING WITH CORNICE
AVAILABLE COLOURS	 WHITE RAL9010  WHITE PRIMER RAL9016  ALUMINIUM  BLACK ANODISED	 WHITE RAL9010  ALU ANODISED  BLACK ANODISED	 WHITE PRIMER RAL9016  BLACK STRUCTURE	 WHITE RAL9003  ALU ANODISED  BLACK ANODISED	 WHITE PRIMER RAL9016
AVAILABLE LENGTH	200 cm 300 cm	200 cm 300 cm	200 cm 300 cm	200 cm 300 cm 600 cm	200 cm

				
	CLICK RAIL	CLICK RAIL PRO	CONTOUR RAIL	CONTOUR RAIL GLUED
WEIGHT CAPACITY (PER METER)	MAX. 30 kg	MAX. 50 kg	MAX. 20 kg	MAX. 10 kg
SIZE RAIL				
INSTALLATION	WALL, FLUSH AGAINST CEILING	WALL, FLUSH AGAINST CEILING	WALL, 15 CM UNDER CEILING	WALL, FLUSH AGAINST CEILING
AVAILABLE COLOURS	 WHITE RAL9010  WHITE PRIMER RAL9016  ALUMINIUM  BLACK	 WHITE RAL9010  ALU BRUSHED	 WHITE PRIMER RAL9016	 WHITE PRIMER RAL9016
AVAILABLE LENGTH	150 cm 200 cm 300 cm 600 cm	200 cm 300 cm	200 cm 300 cm	200 cm 300 cm

				
	DECO RAIL LED	SHADOWLINE DRYWALL	SHADOWLINE MASONRY	XPO RAIL
WEIGHT CAPACITY (PER METER)	MAX. 20 kg	MAX. 20 kg	MAX. 20 kg	MAX. 20 kg
SIZE RAIL				
INSTALLATION	WALL*	INTEGRATED, DRYWALL	INTEGRATED	CEILING
AVAILABLE COLOURS	 WHITE PRIMER RAL9016	 WHITE PRIMER RAL9016	 WHITE PRIMER RAL9016	 WHITE PRIMER RAL9016  BLACK
AVAILABLE LENGTH	200 cm	200 cm	200 cm	200 cm

* mount on wall, determine own height for desired lighting effect

▶ PICTURE HANGING SYSTEMS

WALL

- WALL MOUNTING
- FLUSH AGAINST CEILING
- RAIL CAN BE REPAINTED
- PRESERVATION OF WALLS
- USER-FRIENDLY
- HANG AND MOVE WALL DECORATIONS QUICKLY AND EASY

FLEXIBLE
SAFE
STRONG



CLICK RAIL



30
KG/M

10
YEAR
WARRANTY

CLICK

CONNECT

3 CLIPS / M

The Click Rail is a flexible picture hanging system that you mount to the wall. Using the Click&Connect system, mounting the rail system is fast and easy. The Click Rail may be installed flush against the ceiling and may also be repainted, for example in the same colour as the wall or ceiling. This helps the picture hanging system 'blend in' with the wall or ceiling, making it nearly invisible. The hanging rail's appearance makes it easy to integrate in any room or interior. You always have flexibility in hanging posters, pictures or photo frames thanks to the hanging wires with hooks that you can click into any desired location on the rail system.

RAIL

NEW

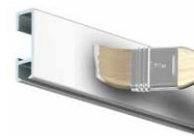

	CLICK RAIL - WHITE RAL 9010		CLICK RAIL - WHITE PRIMER RAL 9016		CLICK RAIL - ALU BRUSHED		CLICK RAIL - BLACK STRUCTURE	
	P/1*	P/20*	P/1*	P/20*	P/1*	P/20*	P/1*	P/20*
ARTICLE NO. 150 cm				9.4360				
ARTICLE NO. 200 cm	9.4303	9.4353	9.4348	9.4350	9.4341	9.4340		05.01210
ARTICLE NO. 300 cm	9.4304	9.4354	9.4349	9.4351	9.4343	9.4342		05.01310
ARTICLE NO. 600 cm	9.4372		9.4346					
	FASTENER KIT WHITE		FASTENER KIT WHITE		FASTENER KIT GREY		FASTENER KIT BLACK	
ARTICLE NO. 200 cm	4065		4065		4064		5094	
ARTICLE NO. 300 cm	4061		4061		4060		5095	

FLEXIBLE
STRONG
RELIABLE

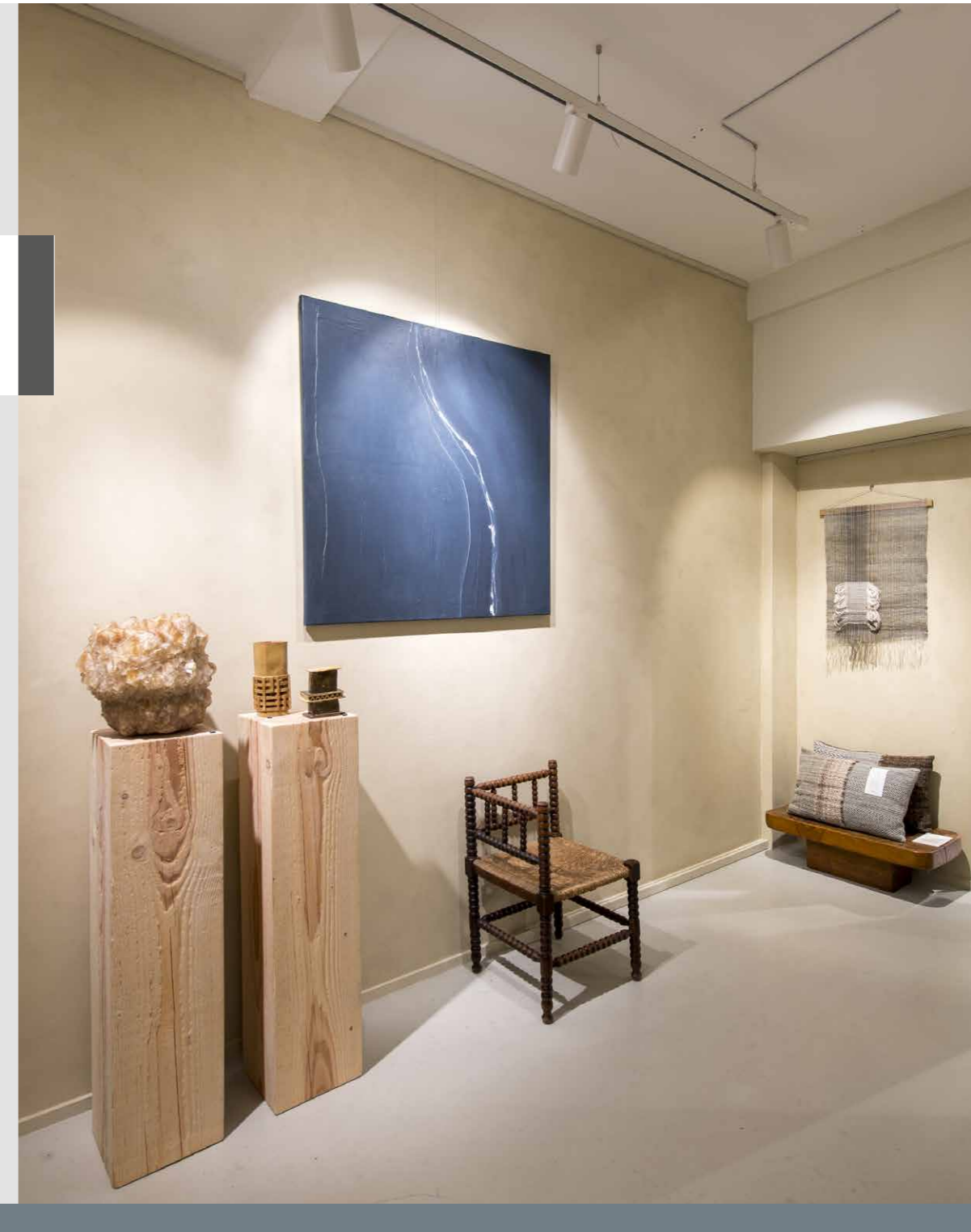

CONTENT FASTENER KIT



		QUANTITY 200 cm	QUANTITY 300 cm
9.4113	CLICK&CONNECT	6x	9x
9.4945	SCREW	6x	9x
9.4934	PLUG	6x	9x
9.4105 (WHITE) / 9.4104 (GREY) / 9.4112 (BLACK)	END CAP	2x	2x
9.4107 (WHITE) / 9.4108 (GREY) / 9.4114 (BLACK)	CORNER CONNECTOR	1x	1x
2386	INSTRUCTION	1x	1x

ALL MOUNTING MATERIAL MAY BE ORDERED SEPARATELY. SEE OVERVIEW ON PAGE 40
* P/1: PACKAGED BY THE PIECE IN FOIL / P/20: PACKAGED PER 20 IN FOIL

CLICK RAIL PRO

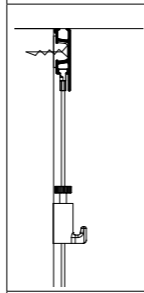
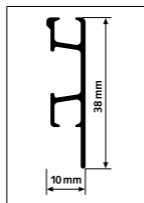

50
KG/M

10
YEAR
WARRANTY

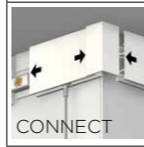
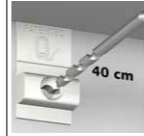

3 CLIPS / M

The Click Rail Pro hanging system is the professional, heavy-duty version of the Click Rail. The rail is quick and easy to instal thanks to the Click&Connect clips, and can be mounted on the wall, flush against the ceiling. It is possible to mount the rail in such a way that the sliders for the hanging wire may be subtly hidden behind the rail. The Click Rail Pro picture hanging system has a maximum load capacity of 50 kg/m. Hanging heavy pictures and wall decorations is no problem with the Click Rail Pro. Click Rail Pro is a strong picture hanging system that you can trust when it comes to hanging your art on the wall. The hanging wires may be moved and clicked into the rail again at any desired location. This assures you of flexibility in what you display on your walls. Moving or replacing a work of art is fast and easy, and there's no risk of damaging the walls.

RAIL

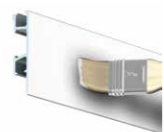

CLICK RAIL PRO - WHITE PRIMER
RAL 9016



CLICK RAIL PRO - ALU BRUSHED

ARTICLE NO. 200 cm	05.05420	05.05320
ARTICLE NO. 300 cm	05.05430	05.05330
FASTENER KIT WHITE		FASTENER KIT GREY
ARTICLE NO. 200 cm	4067	4066
ARTICLE NO. 300 cm	4074	4073

CLICK RAIL PRO



installation
video

CONTENT FASTENER KIT



		QUANTITY 200 cm	QUANTITY 300 cm
9.4124	CLICK&CONNECT	6x	9x
9.4945	SCREW	6x	9x
9.4934	PLUG	6x	9x
9.4120 (WHITE) / 9.4121 (GREY)	END CAP	2x	2x
9.4122 (WHITE) / 9.4123 (GREY)	CORNER CONNECTOR	1x	1x
2387	INSTRUCTION	1x	1x

ALL MOUNTING MATERIAL MAY BE ORDERED SEPERATELY. SEE OVERVIEW ON PAGE 40

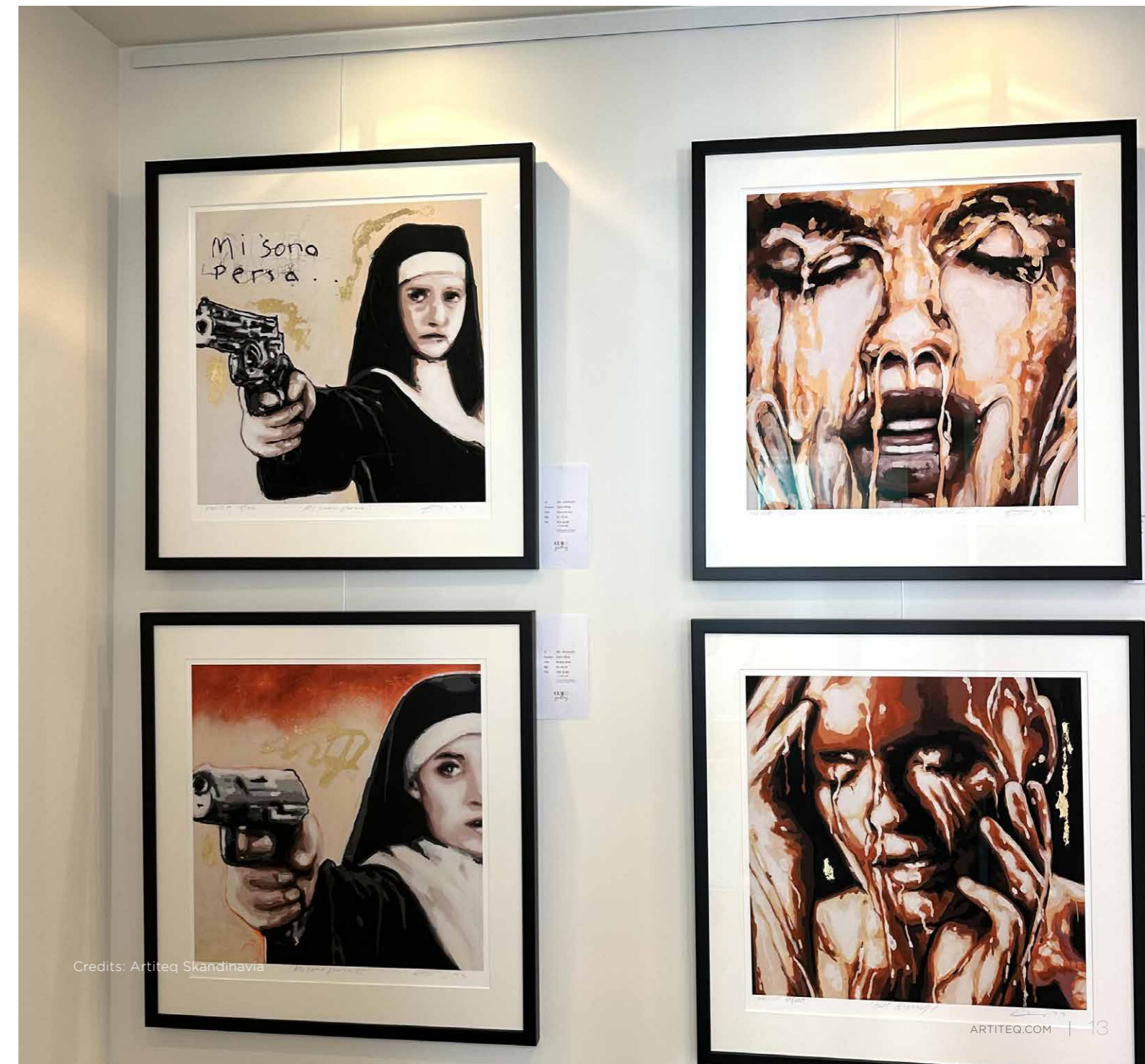

Credits: Artiteq Skandinavia

CONTOUR RAIL

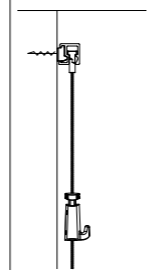
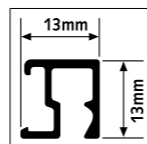

20
KG/M

10
YEAR
WARRANTY



3 CLIPS / M

Compact and attractive hanging system

"Less rail, more art". Contour Rail gets the job done in spite of its minimal dimensions, and has an attractive, sleek design. Hanging pictures, or hanging and moving framed photos is easy thanks to the Contour Rail. Using the clips, the picture rails may be mounted to the wall (minimum distance from the ceiling: 15 mm). In addition to the aluminium version of the rail, the available model in white may be painted in any colour. The refined style of the 1 mm Twister hanging wires with Micro Grip 1 mm suspension hook make them a perfect match for the compact shape of this hanging system.

RAIL



CONTOUR RAIL - WHITE PRIMER RAL 9016

END CAP

200 cm P/1*

300 cm P/1*

WHITE

ARTICLE NO. 30.11201

30.11301

30.31210

FASTENER KIT WHITE

ARTICLE NO. 30.31310

30.31330

CONTENT FASTENER KIT



			QUANTITY 200 cm	QUANTITY 300 cm
30.31110	CLICK&CONNECT		6x	9x
9.4945	SCREW		6x	9x
9.4934	PLUG		6x	9x
30.31210 (WHITE)	END CAP		2x	2x
2388	INSTRUCTION		1x	1x

ALL MOUNTING MATERIAL MAY BE ORDERED SEPARATELY. SEE OVERVIEW ON PAGE 40
* P/1: PACKAGED BY THE PIECE IN FOIL



installation video



Credits: @huiswaarts

CONTOUR RAIL GLUED



10
KG/M

10
YEAR
WARRANTY

Contour Rail glued - hanging without drilling

Looking for a compact hanging rail that 'disappears' in a room? Contour Rail offers the solution: the rail can also be mounted to the ceiling using glue. Thanks to the special design, the glue may be applied in and on the profile in the desired manner. When the Contour Rail is glued and painted in the same colour as the wall, it becomes inconspicuous while still offering all the advantages of a flexible hanging system: the ability to hang and move pictures without damaging the walls.

RAIL



CONTOUR RAIL - WHITE PRIMER RAL 9016

END CAP

200 cm P/1*

300 cm P/1*

WHITE

ARTICLE NO. 30.11201

30.11301

30.31210

FASTENER MATERIAL



CONTOUR RAIL GLUE SET (FOR FIXATION OF 4,5-5M)

3M SURFACE CLEANERS & GLUE PARABOND 600 WHITE 290 ML

ARTICLE NO.

30.31180

*P/1: PACKAGED BY THE PIECE IN FOIL

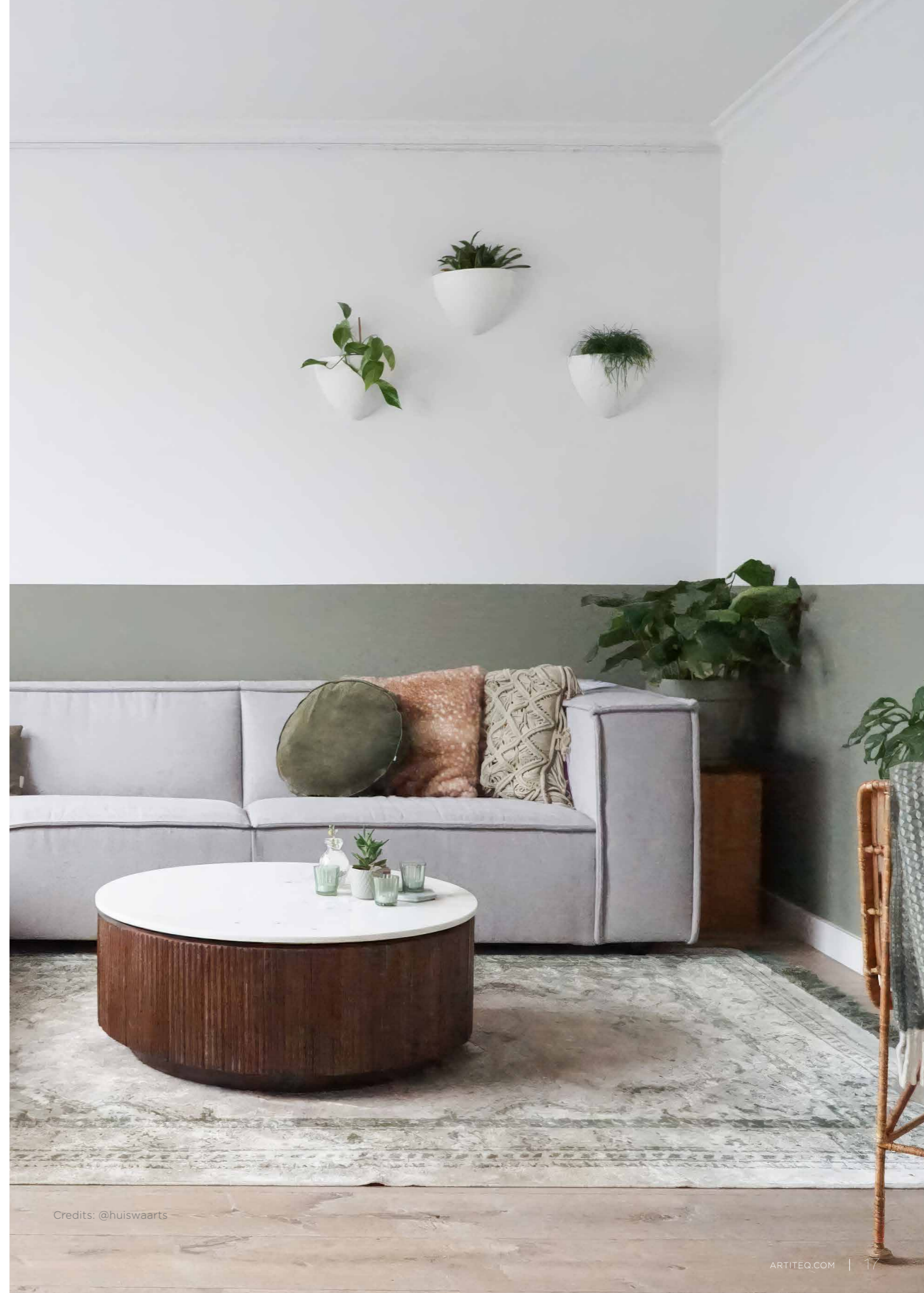

Credits: @huiswaarts

CLASSIC RAIL

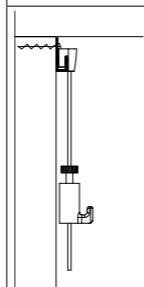
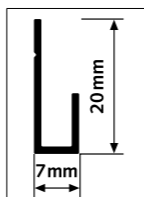

20
KG/M

10
YEAR
WARRANTY



4 SCREWS/ M

Change pictures quickly and easily with Classic Rail

The Classic Rail is a wall rail that is often used in galleries and at exhibitions. This hanging system has an open J-shape which, with the aid of rods and sliding springs, makes it easy to hang pictures and other wall decorations. If you are looking for a discreet alternative to a rod, it is possible to use a cylinder hook with a transparent perlon cord in the rail. Depending on the weight of the picture or wall decoration, various hooks may be slid onto the perlon hanging wire.

A hanging rail for a contemporary interior

The Classic Rail is a J-shaped, open rail system with a modern look. This picture hanging system is available in white, aluminum and black. The rods that may be placed in the rail vary in thickness from 2 to 3 mm, and have a maximum load capacity of 20 kg. Available in white or steel, the rods use various sliding springs.

RAIL



	CLASSIC RAIL - WHITE RAL 9010		CLASSIC RAIL - WHITE PRIMER RAL 9016		CLASSIC RAIL - ALU		CLASSIC RAIL - BLACK ANODISED	
	P/1*	P/20*	P/1*	P/20*	P/1*	P/20*	P/1*	P/20*
ARTICLE NO. 200 cm	9.4307	9.4357	-	9.4390	9.4305	-	9.4384	-
ARTICLE NO. 300 cm	9.4308	9.4358	-	-	9.4306	-	-	-
	FASTENER KIT WHITE		FASTENER KIT WHITE		FASTENER KIT GREY		FASTENER KIT BLACK	
ARTICLE NO. 200 cm	4072		4072		4071		5097	
ARTICLE NO. 300 cm	4079		4079		4078		-	



installation video

CONTENT FASTENER KIT

		QUANTITY 200 cm	QUANTITY 300 cm
9.4941 (WHITE) / 9.4942 (GREY) / 9.4943 (BLACK)	SCREW	8x	12x
9.4934	PLUG	8x	12x
2389	INSTRUCTION	1x	1x

ALL MOUNTING MATERIAL MAY BE ORDERED SEPARATELY. SEE OVERVIEW ON PAGE 40
* P/1: PACKAGED BY THE PIECE IN FOIL / P/20 PACKAGED PER 20 IN FOIL

RODS



	ROD WHITE STEEL U-TOP 2 mm MAX. 20 kg	ROD WHITE STEEL U-TOP 3 mm MAX. 20 kg	ROD STEEL U-TOP 3 mm MAX. 20 kg
ARTICLE NO. 100 cm	9.4216*	9.4161	9.4151
ARTICLE NO. 150 cm	-	9.4162	9.4152
ARTICLE NO. 200 cm	9.4217*	9.4163	9.4153
ARTICLE NO. 300 cm	-	9.4165	9.4155

*COMPATIBLE WITH HOOKS 9.4207, 9.4261, 3041200/50 - SEE PAGE 66.

SLIDING SPRINGS



SLIDING SPRING STAINLESS STEEL 3 mm MAX. 20 kg
9.4170

CYLINDER HOOKS



CYLINDER HOOK WHITE MAX. 15 kg	CYLINDER HOOK ALU MAX. 15 kg	CYLINDER HOOK BLACK MAX. 15 kg
9.4237	9.4244	9.4240

FOR USE WITH HANGING WIRE SLIDER ECONOMY 2 mm

WIRES



SLIDER ECONOMY 2 mm MAX. 15 kg	
ARTICLE NO. 100 cm	9.4424
ARTICLE NO. 150 cm	9.4425
ARTICLE NO. 200 cm	9.4426
ARTICLE NO. 250 cm	9.4427
ARTICLE NO. 300 cm	9.4428



MICRO GRIP 2 mm
30.41200 | 20 kg



MICRO GRIP LOCK 2 mm
30.41250 | 20 kg

FOR MORE PICTURE HOOKS SEE PAGE 66.

CLASSIC RAIL+

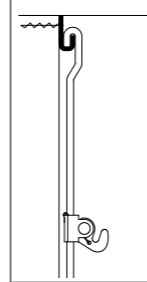
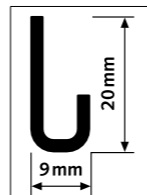

40
KG/M

10
YEAR
WARRANTY



4 SCREWS/ M

The Classic Rail+ is a picture hanging system for walls that has been specially developed for hanging heavier pictures and wall decorations (up to 40 kg). This hanging system is often used in galleries, at exhibitions and in museums. The hanging rail has an open, J-shaped design that makes it possible to hang a variety of rods equipped with rod hooks. This makes it extremely easy to hang or change art on the wall. The Classic Rail + is available in white, aluminum and black versions. A variety of aluminium or steel rods may be used for decorations weighing up to a maximum of 40 kg.

Secure picture hanging system

The Classic Rail+ makes it possible to hang pictures and wall decorations in a secure manner in rooms where this is required. Thanks to a blocking device, the rod is blocked in the rail and the picture enjoys extra protection when special anti-theft hooks are used on the rod itself.

RAIL		
	NEW	
CLASSIC RAIL+ - WHITE RAL 9010	CLASSIC RAIL+ - ALU ANODISED	CLASSIC RAIL+ - BLACK ANODISED
P/1*	P/1*	P/1*
ARTICLE NO. 200 cm	9.4318	9.4320
ARTICLE NO. 300 cm	9.4319	9.4321
		-
	FASTENER KIT WHITE	FASTENER KIT GREY
ARTICLE NO. 200 cm	4072	4071
ARTICLE NO. 300 cm	4079	4078
		5097
		-



installation video

CONTENT FASTENER KIT



		QUANTITY 200 cm	QUANTITY 300 cm
9.4941 (WHITE) / 9.4942 (GREY) / 9.4943 (BLACK)	SCREW	8x	12x
9.4934	PLUG	8x	12x
2389	INSTRUCTION	1x	1x

ALL MOUNTING MATERIAL MAY BE ORDERED SEPERATELY. SEE OVERVIEW ON PAGE 40
* P/1: PACKAGED BY THE PIECE IN FOIL

RODS 4 x 4 mm ALUMINIUM

NEW

	ROD ALUMINIUM S-BEND WHITE	ROD ALUMINIUM S-BEND ALU	STANG ALUMINIUM S-BEND BLACK
	MAX. 20 KG	MAX. 20 KG	MAX. 20 KG
ARTICLE NO. 100 cm	9.4277	9.4271	-
ARTICLE NO. 150 cm	9.4278	9.4272	-
ARTICLE NO. 200 cm	9.4279	9.4273	9.4276
ARTICLE NO. 250 cm	9.4280	9.4274	-

HOOKS



CLAMPING HOOK
20 kg

4 X 4 mm

ARTICLE NO. 9.4253

COMPATIBLE ONLY WITH 4 X 4 mm ALUMINIUM RODS

ROD 4 x 4 mm STEEL



ROD U-TOP
STEEL WHITE

MAX. 40 KG

ARTICLE NO. 100 cm	9.4220
ARTICLE NO. 150 cm	9.4221

HOOKS



CLAMPING HOOK
40 kg

4 x 4 mm

ARTICLE NO. 9.4297

COMPATIBLE ONLY WITH 4 X 4 mm STEEL RODS

ANTI-THEFT DEVICES*



BLOCKING DEVICE
WHITE

4 x 4 mm

ARTICLE NO. 9.4290



CLAMPING HOOK STEEL
ANTI-THEFT 40 kg

4 x 4 mm

ARTICLE NO. 9.4291



BLOCKING SLEEVE

6 x 12 x 8 mm

ARTICLE NO. 9.4293

ALLEN KEY

2,5 mm

ARTICLE NO. 9.3390

ALLEN KEY

2,0 mm

ARTICLE NO. 9.3394

*ONLY FOR USE WITH ROD U-TOP STEEL WHITE 9.4220/9.4221/9.4222



- MOUNTING NEXT TO RECESSED CEILING OR CEILING
- RAIL DISAPPEARS IN CEILING
- PRESERVATION OF WALLS
- USER-FRIENDLY
- HANG AND MOVE WALL DECORATIONS QUICKLY AND EASY

CEILING

COMPACT
DESIGN
HIGH END

▶ PICTURE HANGING SYSTEMS

UP RAIL



The Up Rail is the leading ceiling rail par excellence; the rail is especially suitable when used in combination with concrete. The picture hanging system is clicked into place using clips (3 clips each metre) which are attached to the ceiling. The beautiful rounded shape of the rail fills the space between the wall and ceiling, therefore the picture hanging system is discrete and unobtrusive. The maximum bearing capacity of 20 kg/m makes the Up Rail a solid and reliable hanging system. The rail has a white, primed finish: the hanging rail can be painted in any preferred colour (for example, in the colour of the wall or ceiling). The Twister hanging wires can be clicked anywhere along the rail. If a ceiling mounting is required, for example if the walls may not be damaged or because it is not possible to attach a rail to the walls, the Up Rail is the ideal solution for flexible adornment of the walls.

RAIL



UP RAIL - WHITE PRIMER RAL 9016		FASTENER KIT WHITE		UP RAIL - BLACK STRUCTURE		FASTENER KIT BLACK	
ARTICLE NO.	200 cm	05.06200	4098	05.06210	5096		
ARTICLE NO.	300 cm	05.06300	4099				

CONTENT FASTENER KIT



installation video



			QUANTITY 200 cm	QUANTITY 300 cm
05.06010	CLICK&CONNECT		6x	9x
9.4945	SCREW		6x	9x
9.4934	PLUG		6x	9x
05.06020 (WHITE) / 05.06030 (BLACK)	SET END CAPS L&R		2x	2x
2563	INSTRUCTION		1x	1x

ALL MOUNTING MATERIALS MAY BE ORDERED SEPERATELY, SEE PAGE 40

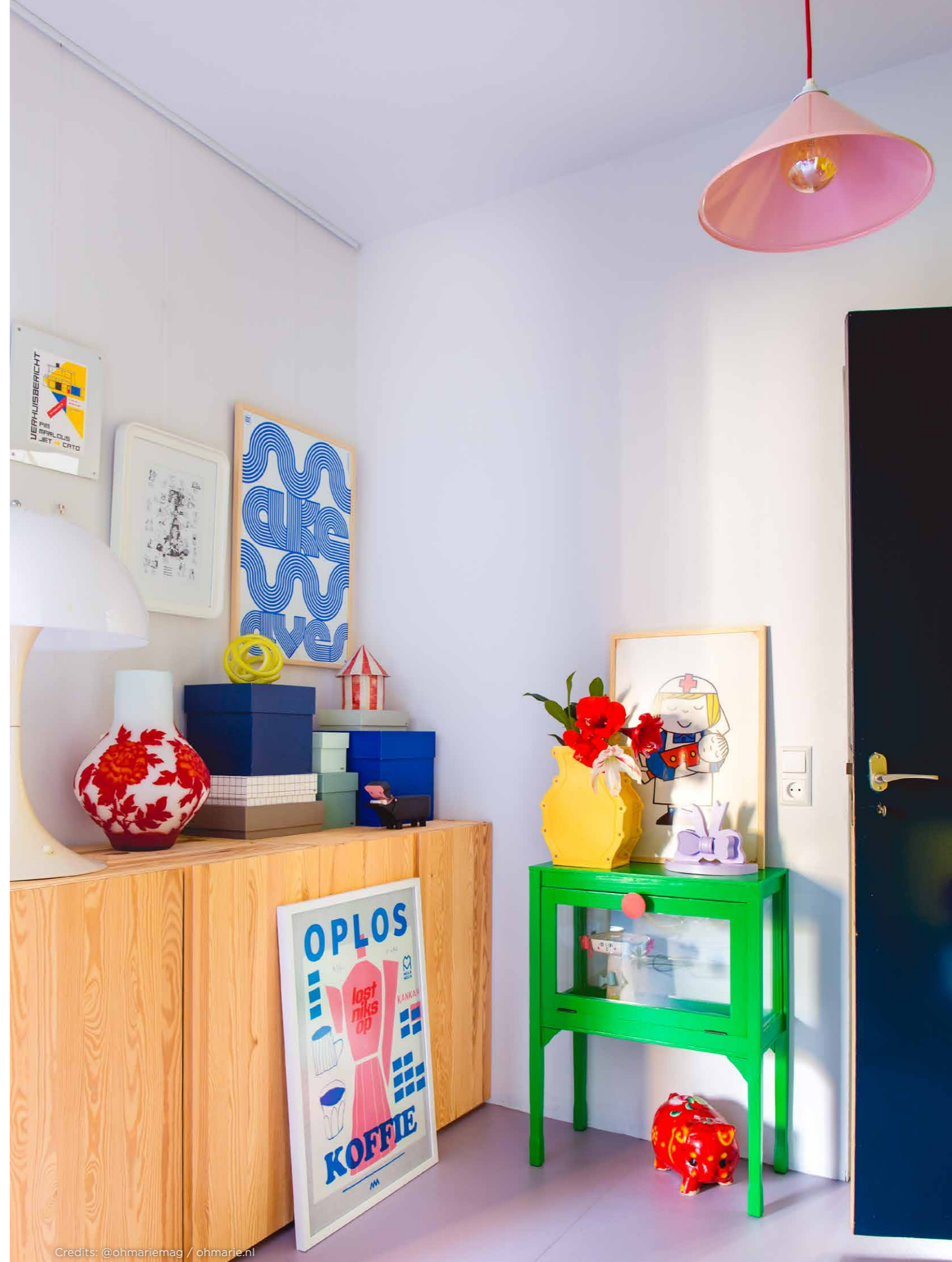

Credits: @ohmariemag / ohmarie.nl

TOP RAIL



20
KG/M

10
YEAR
WARRANTY

8 SCREWS / M

The flexible picture hanging system Top Rail is mounted to the ceiling. This ceiling rail that is discreet in its dimensions is an ideal hanging system to use in combination with recessed ceilings. By mounting the ceiling rail to the wooden side strip of a recessed ceiling, the rail 'disappears' into the ceiling. This 'invisible' picture hanging system then offers a flexible way to hang, change and replace pictures and wall decorations throughout the entire room.



RAIL



TOP RAIL - WHITE RAL 9003

TOP RAIL - ALU ANODISED

TOP RAIL - BLACK ANODISED

	TOP RAIL - WHITE RAL 9003		TOP RAIL - ALU ANODISED		TOP RAIL - BLACK ANODISED		
	P/1*	P/10*	P/10*	P/1*	P/10*	P/10*	
ARTICLE NO. 200 cm	9.4309	9.4326	9.4313	9.4378	9.4323		
ARTICLE NO. 300 cm	9.4310	9.4327	9.4314	9.4379	9.4324		
ARTICLE NO. 600 cm	-	9.4362	-	-	9.4367		
		FASTENER KIT WHITE		FASTENER KIT GREY		FASTENER KIT BLACK	
ARTICLE NO. 200 cm		4070		4069		4068	
ARTICLE NO. 300 cm		4077		4076		4075	



CONTENT FASTENER KIT



	9.4912 (WHITE) / 9.4913 (ALU) / 9.4903 (BLACK)	SCREW	QUANTITY 200 cm	QUANTITY 300 cm
			16x	24x
	9.4900	PLUG 4 mm	16x	24x
	2390	INSTRUCTION	1x	1x

ALL MOUNTING MATERIALS MAY BE ORDERED SEPARATELY. SEE PAGE 40 - 8 SCREWS /m
* P/1: PACKAGED BY THE PIECE IN FOIL / P/10 PACKAGED PER 10 IN FOIL



Credits: Artiteq Skandinavië

- FOR BUILDING AND RENOVATION PROJECTS
- RAIL IS INSTALLED WITH CEILING CONSTRUCTION
- HANGING WIRES HANG DIRECTLY FROM CEILING
- PRESERVATION OF WALLS
- USER-FRIENDLY
- HANG AND MOVE WALL DECORATIONS QUICKLY AND EASY

INTEGRATED

DISCRETE
FLEXIBLE
DESIGN

▶ PICTURE HANGING SYSTEMS

DECO RAIL / DECO RAIL LED

DECO RAIL (IN COMBINATION WITH CORNICE)

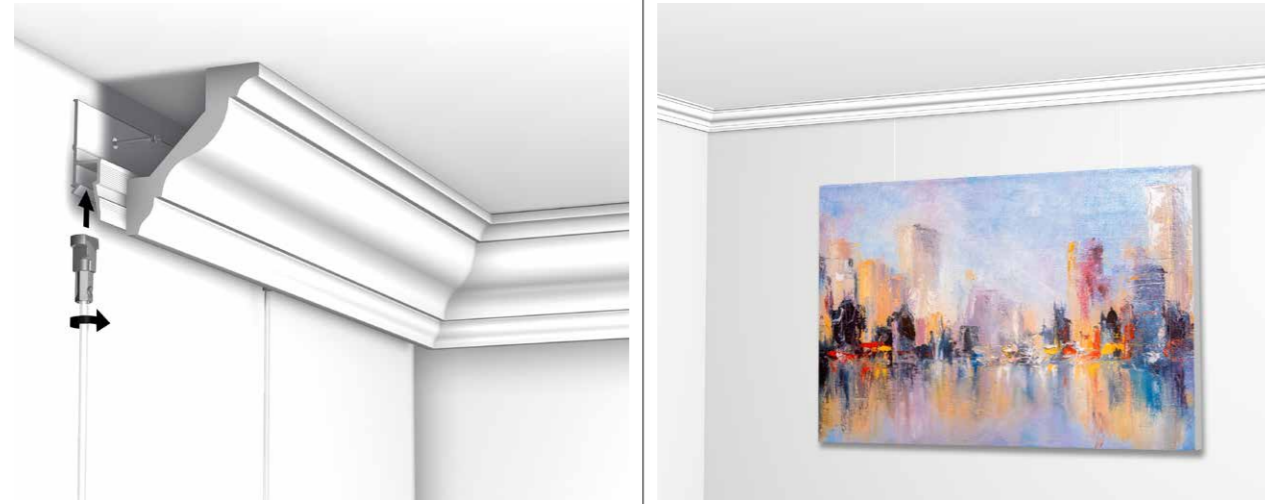

DECO RAIL LED (IN COMBINATION WITH LIGHTING PROFILE)



SHADOWLINE

SHADOWLINE DRYWALL (IN COMBINATION WITH DRYWALL)



SHADOWLINE MASONRY (IN COMBINATION WITH BRICKWALL)



DECO RAIL

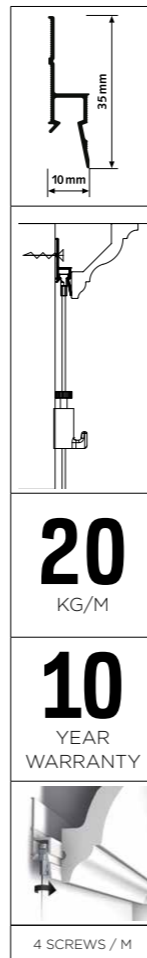

20
KG/M

10
YEAR
WARRANTY



4 SCREWS / M



installation
video

Flexible options for smooth walls with Deco Rail

The Deco Rail is a hanging rail for pictures and wall decorations that is mounted behind a cornice. The hanging system becomes invisible as a result, while still offering all the advantages of a flexible hanging system. Walls with a clean, smooth finish remain undamaged, even though it is still possible to hang and move paintings continually. Hanging wires may be clicked into the rail behind the cornice at any desired location. This is the major benefit of the Deco Rail; flexibility and a guarantee for a high-quality finish. There are many different styles of cornice rails, and this hanging rail can be installed behind every type. The Deco Rail is available in combination with a selection of three different types of cornices: Basic, Modern and Classic.

RAIL / CORNICE MOULDINGS

DECO RAIL - WHITE PRIMER RAL 9016	CX 110 BASIC	CX 126 MODERN	C 213 T CLASSIC
ARTICLE NO. 200 cm	05.75100	05.75110	05.75126
MOULDING DIMENSIONS	4 x 4,5 x 200 cm	9 x 9 x 200 cm	8 x 8 x 200 cm

FASTENER MATERIAL

270 ml	310 ml (for 7,8 m)	8X
ULTRA FX400	FDP500 GLUE	FASTENER KIT
FOR CONNECTING JOINTS	WALL AND CEILING	9.4945 FISCHER duopower 5x25 5 mm
ARTICLE NO.	1014	1016
		8x 9.4934 screw 3,5 x 40 mm
		4088



Credits: @interieurbylien

DECO RAIL LED



Invisible hanging system with subtle indirect lighting

The Deco Rail LED is a hanging system and lighting profile, with subtle indirect LED lighting in one. With the lighting profile C362 by ORAC, you add indirect lighting by diffusing light from the wall. A modern, ambient finish within the interior. Combining the Deco Rail with the lighting profile results in an invisible hanging system and allows flexible adornment of the walls. With no damage to sleekly finished walls, pictures can be hung and moved around whenever you please. Hanging wires can be clicked anywhere along the rail behind the lighting profile. The indirect lighting profile is supplied without the LED.

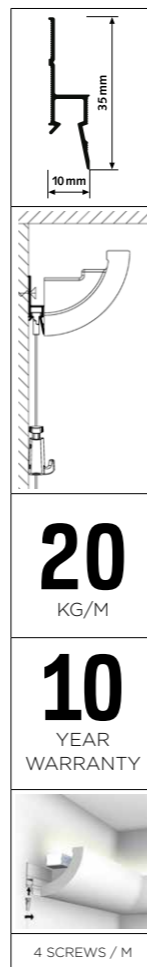

RAIL / LIGHTING PROFILE

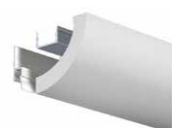

DECO RAIL - WHITE/PRIMER RAL 9016

C362 LIGHTING PROFILE

ARTICLE NO. 200 cm	05.75100	05.75362
PROFILE DIMENSIONS	5 x 5 x 200 cm	

FASTENER MATERIAL



290 ml (voor 7-8 m)

GLUE FOR DECO RAIL LED

FDP700 DECOFIX POWER 290 ML

ARTICLE NO. 1017



8X

FASTENER KIT

9.4945 FISCHER duopower 5x25 5 mm

8x 9.4934 screw 3,5 x 40 mm

4088



Credits: @vanderplayinterieur

PICTURE HANGING SYSTEMS - INTEGRATED

SHADOWLINE DRYWALL

DRYWALL - FIXATION DRYWALL



20
KG/M

10
YEAR
WARRANTY

Hanging rail for plasterboard ceilings and walls (drywall)

The Shadowline rail - drywall enables the placement of an invisible picture hanging system between plasterboard walls and ceiling panels. A discreet shadow line is the only element that appears between the wall and ceiling, and this is where the flexible picture hanging system is hidden. It is possible to install a hanging cord in the rail, anywhere you like in the room. Since the rail itself isn't visible, the hanging cords are suspended directly from the ceiling. If you choose the transparent perlon hanging cords for the rail, you will have the most discreet picture hanging system at your disposal. Using the Shadowline ceiling system means you will always have a guarantee of smooth, clean walls, and the flexibility to decorate them any way you like, without the need for tools.

RAIL



SHADOWLINE DRYWALL - WHITE PRIMER RAL 9016

ARTICLE NO. 200 cm FOR USE WITH DRYWALL 13 mm

05.08440

FASTENER KIT

ARTICLE NO.

4088

CONTENT FASTENER KIT

9.4945	SCREW	8x
9.4934	PLUG	8x

THE RAIL IS NOT PRE DRILLED



installation
video

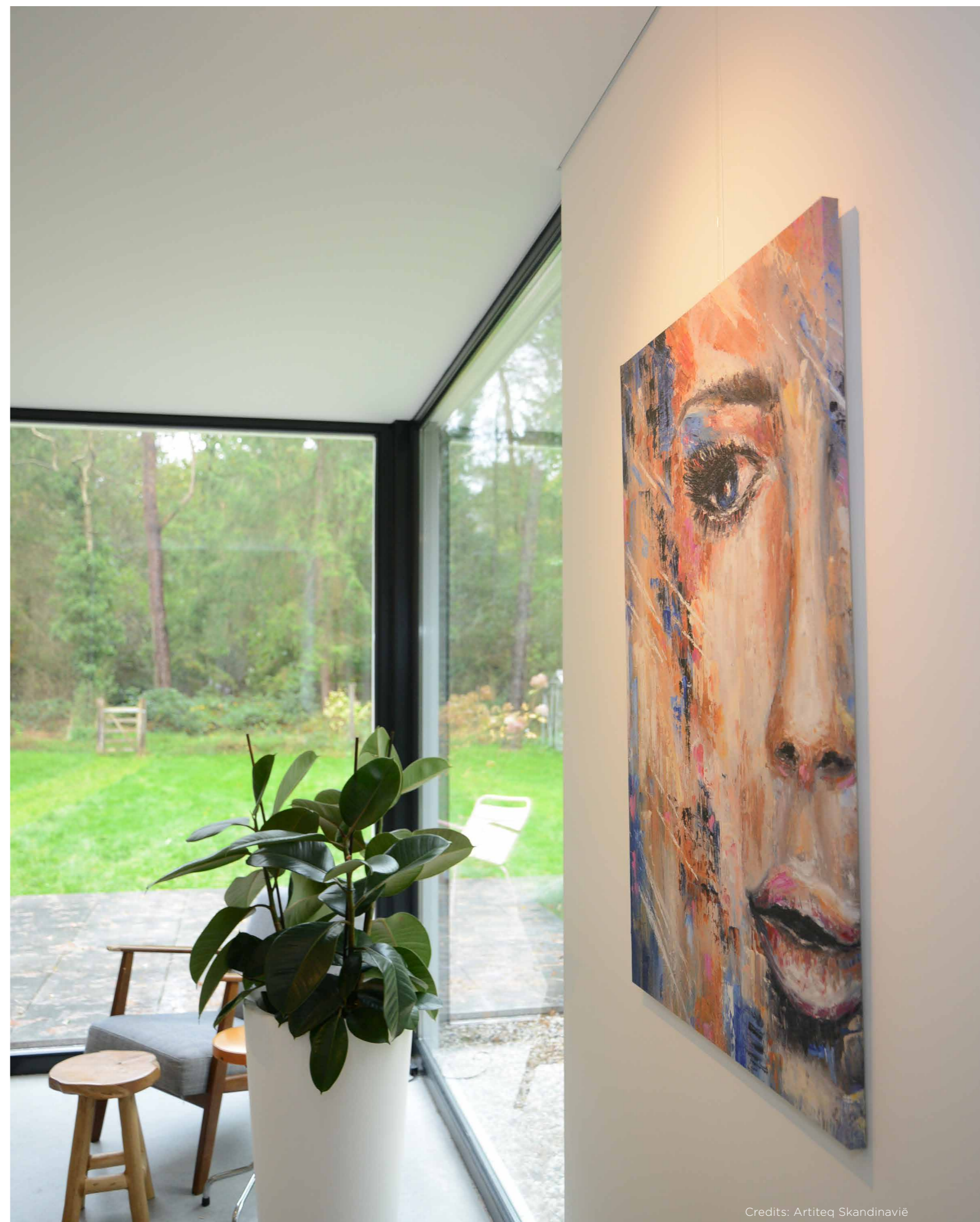

Credits: Artiteq Skandinavië

SHADOWLINE MASONRY

MASONRY - FIXATION STONE WALLS



Hanging rail for plasterboard ceilings and masonry walls

The Shadowline rail - masonry offers the same advantages as the plasterboard version, yet has been specially designed for use with masonry walls. The Shadowline rail is installed on a masonry wall during the building or renovation phase. The Shadowline profile disappears completely in the shadow line next to the ceiling panels, yet still offers all the advantages of a flexible hanging system: undamaged, clean walls and the flexibility to quickly and easily hang paintings and other wall decorations and move them around as desired.

RAIL



SHADOWLINE MASONRY - WHITE PRIMER RAL 9016

ARTICLE NO. 200 cm USE WITH BRICKWALL 13 mm 05.08450

FASTENER KIT

ARTICLE NO. 4088

CONTENT FASTENER KIT

9.4945	SCREW	8x
9.4934	PLUG	8x

THE RAIL IS NOT PRE DRILLED



installation video



Credits: Artiteq Skandinavië

FASTENER MATERIAL

	CLICK&CONNECT 3 CLIPS/m	CLICK&CONNECT 3 RINGS 3 CLIPS/m	FASTENING CLIP ROUND 3 CLIPS/m	CLICK&CONNECT 3 CLIPS/m	CLICK&CONNECT 3 CLIPS/m	CLICK&CONNECT 3 CLIPS/m
	9.4113	9.4119	9.4106	9.4124	30.31110	05.06010
CONTOUR RAIL P. 12					+	
CLICK RAIL P. 08	+	0	0			
CLICK RAIL PRO P. 10				+		
UP RAIL P. 22						+

	END CAP WHITE	END CAP WHITE	END CAP GREY	END CAP BLACK	END CAP WHITE	END CAP GREY	CORNER CONNECTOR WHITE	CORNER CONNECTOR GREY	CORNER CONNECTOR BLACK	CORNER CONNECTOR WHITE	CORNER CONNECTOR GREY	SET END CAPS L&R WHITE	SET END CAPS L&R BLACK
	30.31210	9.4105	9.4104	9.4112	9.4120	9.4121	9.4107	9.4108	9.4114	9.4122	9.4123	05.06020	05.06030
CONTOUR RAIL	+												
CLICK RAIL		+	+	+			+	+	+				
CLICK RAIL PRO					+	+				+	+		
UP RAIL												+	+

NEW

	FISCHER DUOPOWER 5x25 5 mm	SCREW 3,5 mm x 40 mm WHITE	SCREW 3,5 mm x 40 mm ALU	SCREW 3,5 mm x 40 mm BLACK	SCREW 3,5 mm x 40 mm	PLUG 4 mm	SCREW 9.4912 (WHITE) / 9.4913 (ALU) / 9.4903 (BLACK)	SCREW METAL STUD 3,5 mm x 38 mm (FOR USE WITH METAL) (NO PLUG)
	9.4934	9.4941	9.4942	9.4943	9.4945	9.4900	9.4912/13/03	9.4928
CONTOUR RAIL P. 14	+	+	+	+	+			+
CLICK RAIL P. 10	+	+	+	+	+			+
CLICK RAIL PRO P. 12	+	+	+	+	+			+
CLASSIC RAIL P. 18	+	+	+	+	+			
CLASSIC RAIL+ P. 20	+	+	+	+	+			
UP RAIL P. 24	+	+	+	+	+			+
TOP RAIL P. 26						+	+	
DECO RAIL P. 32	+	+	+	+	+			+
SHADOWLINE DRYWALL P. 36								
SHADOWLINE MASONRY P. 38	+	+	+	+	+			

CLASSIC RAIL, CLASSIC RAIL+ AND DECO RAIL: 1 SCREW PER 250 mm
SHADOWLINE MASONRY : 1 SCREW PER 300 mm
TOP RAIL : 1 SCREW PER 125 mm

FASTENER MATERIAL

FASTENER KITS



	WHITE		WHITE PRIMER		ALU		BLACK	
	200 cm	300 cm	200 cm	300 cm	200 cm	300 cm	200 cm	300 cm
CONTOUR RAIL			30.31310	30.31330				
CLICK RAIL	4065	4061	4065	4061	4064	4060	5094	5095
CLICK RAIL PRO			4067	4074	4066	4073		
CLASSIC RAIL	4072	4079	4072	4079	4071	4078	5097	
CLASSIC RAIL +	4072	4079			4071	4078	5097	
UP RAIL			4098	4099			5096	
TOP RAIL	4070	4077	4070	4077	4069	4076	4068	4075
DECO RAIL	4088							
DECO RAIL LED	4088							
SHADOWLINE DRYWALL	4088							
SHADOWLINE MASONRY	4088							



all installation videos



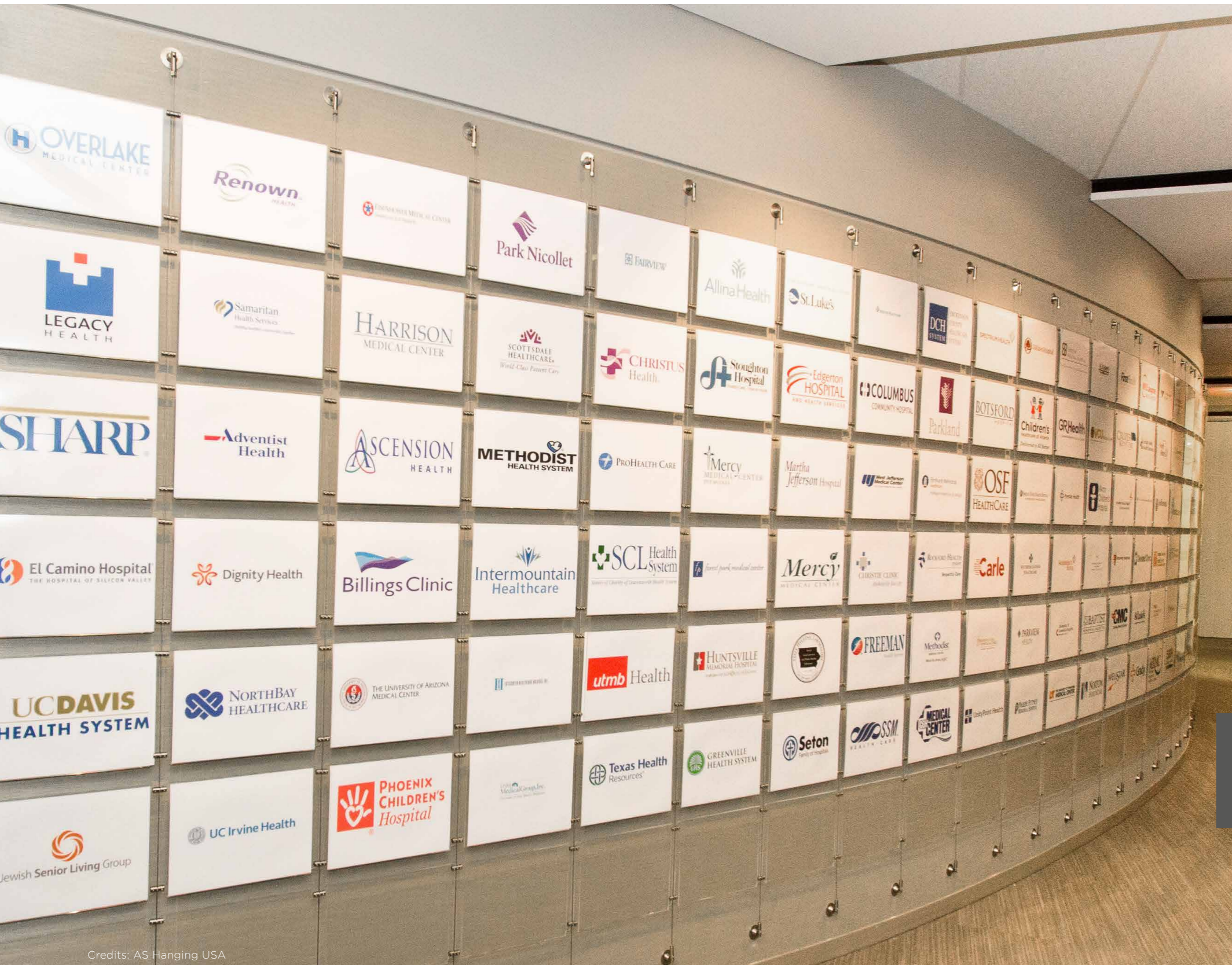

Credits: AS Hanging USA

SOLO

FLEXIBLE
STRONG
SAFE

▶ PICTURE HANGING SYSTEMS

BOTANIQ

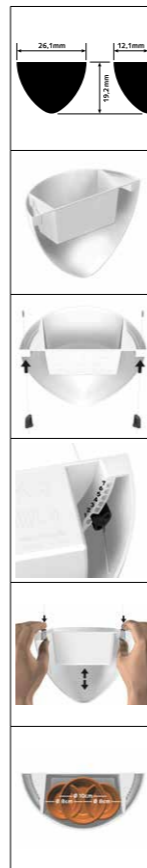

installation video

Make room for plants on the wall

There is always room for plants in your home or office. Create a surprising and dynamic effect with the Artiteq Botaniq hanging flowerpot. Hang your plants optimally with the stylish Botaniq with soft round shapes. The Botaniq comes with two 1mm perlon Twister hanging wires and two Micro Grip hooks, so you can easily hang it at the right height within Artiteq's hanging rail. The Botaniq hanging flowerpot can only be used in combination with a picture hanging rail. Choose your color and combine with several other hanging pots at different heights to give your interior an urban jungle and natural touch!

BOTANIQ COMPLETE SET



BOTANIQ WHITE 1,25 L

BOTANIQ GREEN 1,25 L

2X



MICRO GRIP 1mm

2X



TWISTER PERLON 1mm
150cm

1x



BOTANIQ HANGING FLOWERPOT
WHITE / GREEN*

SIZE*	261x192x121 mm	261x192x121 mm
MAX. WEIGHT	5 kg	5 kg
ARTICLE NO.	7600.110	7600.120

*COMPATIBLE FOR POT SIZE OF MAX. Ø10 cm



UNIQ HANGER

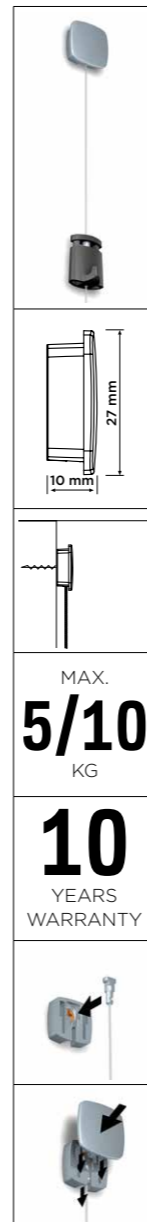

A different way to hang wall decorations

In some spaces, it either isn't possible or desirable to use a hanging rail. The Uniq Hanger offers a solution for these situations. Not only is it easy and safe to hang a picture frame on the wall and easily adjust the height, but it also creates a certain look. The combination of the stainless steel button with the steel wire might result in just the look you want to create in an interior. You also have the option of fully concealing the system behind your photo frame or painting.

Hanging a frame without a rail

The Uniq Hanger consists of a wall fitting with cover, Twister 1 mm steel wire and a Micro Grip 1 mm suspension hook. It's easy to insert the steel wire in the wall fitting, and then just slide the stainless steel cover over this. After you slide the Micro Grip 1 mm over the steel wire, you can adjust the height. The Uniq Hanger may also be used with perlon hanging wires.

UNIQU HANGER		
ø 6mm	max. 10 kg	max. 5 kg
UNIQU HANGER	SET UNIQU HANGER TWISTER 1 mm STEELWIRE 200 cm + MICRO GRIP 1 mm	SET UNIQU HANGER TWISTER 1 mm PERLON 200 cm + MICRO GRIP 1 mm
ARTICLE NO. 7805.042	7840.220	7840.240

DISPLAY IT SOLO SET

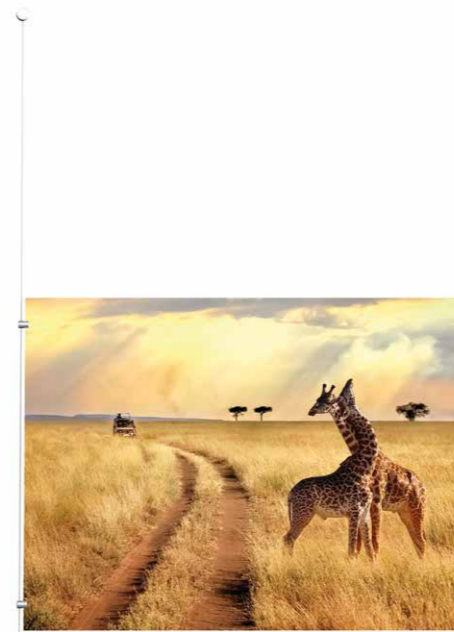

A sleek hanging system for walls

Display It Solo Set is a hanging system for plates with thicknesses ranging from 3 to 6 mm, making it ideal for hanging Plexiglas and acrylic plates. With this system photos can be displayed in a sleek and safe way on the wall. Display It Solo Set is a display system that is easy to mount to the wall. The system consists of 2 buttons that are mounted to the wall, and then the Twister hanging cords are then Twister hanging cords hooked into them. Using the 4 clamps, you then attach the acrylic or Dibond plate to the perlon wire. This display system may also be used in combination with our hanging rails.

DISPLAY IT SOLO SET				
4x	2x	2x		2x
CLAMP SINGLE 3-6 mm	WALL CLIP + COVER WHITE	FASTENER MATERIAL	TWISTER 2 mm PERLON	
	PLASTIC		200 cm	
ARTICLE NO. 7840.150	7805.030	7805.040	9.4929 / 9.4930 / 9.3394	09.23200

DROP CEILING CLIPPHANGER



MAX
4
KG/M

10
YEARS
WARRANTY

Hanging set for hanging frames on a drop ceiling

Versatile and efficient drop ceiling hanging solution to hang (light) posters, paintings and frames from a drop ceiling. The Drop Ceiling Clipphanger has a quick and easy installation. Slide the Drop Ceiling Clipphanger onto the drop ceiling at the end of the wall. The perlon wire 200 cm is already attached to the clip. Attach the hook onto the perlon wire for hanging posters, frames, or paintings with a maximum weight of 4 kg.

COMPLETE SET

NEW

<p>1X</p> <p>SET DROP CEILING CLIPPHANGER WHITE 1X 200 cm PERLON WIRE + MINI HOOK 4 kg</p> <p>ARTICLE NO. 7807.560</p>	<p>1X</p> <p>SET DROP CEILING CLIPPHANGER BLACK 1X 200 cm PERLON WIRE + MINI HOOK 4 kg</p> <p>ARTICLE NO. 7807.561</p>
--	--

DROP CEILINGHANGER

NEW



MAX
4
KG/M

10
YEARS
WARRANTY

Hanging set for hanging frames on a drop ceiling

For hanging light posters, frames and paintings from a drop ceiling, against the wall, the Drop Ceilinghanger is a convenient and quick solution. The Drop Ceilinghanger is combined with the Slider Economy hanging wires and matching hanging hook. Thanks to the flexibility of using the Slider Economy hanging wires, different lengths of wire can be chosen. Insert the Slider Economy hanging wire from the top through the Drop Ceilinghanger and attach it to the drop ceiling with 1 click. Maximum load capacity is 4 kg.

<p>DROP CEILINGHANGER</p> <p>ARTICLE NO. 7807.135</p>	<p>HANGING WIRE</p> <table border="1"> <tr><td>9.4424</td><td>SLIDER ECONOMY</td></tr> <tr><td>9.4425</td><td>SLIDER ECONOMY</td></tr> <tr><td>9.4426</td><td>SLIDER ECONOMY</td></tr> <tr><td>9.4427</td><td>SLIDER ECONOMY</td></tr> <tr><td>9.4428</td><td>SLIDER ECONOMY</td></tr> </table>	9.4424	SLIDER ECONOMY	9.4425	SLIDER ECONOMY	9.4426	SLIDER ECONOMY	9.4427	SLIDER ECONOMY	9.4428	SLIDER ECONOMY	<p>HOOK</p> <p>ARTICLE NO. 9.4205 4 kg manual</p>
9.4424	SLIDER ECONOMY											
9.4425	SLIDER ECONOMY											
9.4426	SLIDER ECONOMY											
9.4427	SLIDER ECONOMY											
9.4428	SLIDER ECONOMY											

PARTITION WALL HOOKS



HOOKS



PARTITION WALL HOOK			
SIZE	16 mm	21 mm	31 mm
COLOUR	WHITE	WHITE	WHITE
MAX. CAPACITY	15 kg	15 kg	15 kg
ARTICLE NO.	9.4503	9.4504	9.4506

HANGING WIRES



9.4424	SLIDER ECONOMY	2 mm	100 cm
9.4425	SLIDER ECONOMY	2 mm	150 cm
9.4426	SLIDER ECONOMY	2 mm	200 cm
9.4427	SLIDER ECONOMY	2 mm	250 cm
9.4428	SLIDER ECONOMY	2 mm	300 cm



MICRO GRIP 2 mm
30.41200 | 20 kg



MICRO GRIP LOCK 2 mm
30.41250 | 20 kg

FOR OVERVIEW HOOKS AND HANGING SETS SEE PAGE 62-73

Flexible and solid

Since it is not always possible (or allowed) to hang rails in every room, we also offer solutions for hanging pictures and wall decorations in the form of partition wall hooks. We offer a range of various types of partition wall hooks for rooms with partitions, giving you a solid, practical way to hang pictures and decorations even on these types of walls. Partition wall hooks are hung over the top of a wall, and then used in combination with a perlon or other type of cord fitted with a picture hook. We offer a variety of solutions depending on the weight of the picture or decoration to be hung.

HOOKS



PARTITION WALL HOOK			PARTITION WALL HOOK FLEX		
SIZE	16 mm	21 mm	31 mm	11-30 mm	
COLOUR	WHITE	WHITE	WHITE	STAINLESS STEEL	WHITE
MAX. CAPACITY	15 kg	15 kg	15 kg	3 kg	3 kg
ARTICLE NO.	9.4503	9.4504	9.4506	9.4540	9.4541

HOOKS



S-HOOK	GALLERY HOOK		GALLERY HOOK LARGE				
SIZE	2 mm	18 mm		20 mm			
COLOUR	WHITE	WHITE	NICKEL-PLATED	BRASS	WHITE	NICKEL-PLATED	BRASS
MAX. CAPACITY	20 kg	12,5 kg	12,5 kg	12,5 kg	20 kg	20 kg	20 kg
ARTICLE NO.	9.4500	9.4239	9.4238	9.4241	9.4247	9.4246	9.4248

HANGING WIRES



9.4412	PERLON + LOOP	2 mm	100 cm
9.4413	PERLON + LOOP	2 mm	150 cm
9.4414	PERLON + LOOP	2 mm	200 cm
9.4415	PERLON + LOOP	2 mm	250 cm
9.4416	PERLON + LOOP	2 mm	300 cm
9.4975	STEELWIRE + LOOP	2 mm	100 cm
9.4976	STEELWIRE + LOOP	2 mm	150 cm
9.4977	STEELWIRE + LOOP	2 mm	200 cm
9.4978	STEELWIRE + LOOP	2 mm	250 cm
9.4979	STEELWIRE + LOOP	2 mm	300 cm



MICRO GRIP 2 mm
30.41200 | 20 kg



MICRO GRIP Lock 2 mm
30.41250 | 20 kg

FOR MORE HOOKS SEE PAGE 66.

MAGNETIC PICTURE HOOKS



7410.001	MAGNETIC PICTURE HOOK STEEL	100 x 53 mm	MAX. 1 kg
7410.002	MAGNETIC PICTURE HOOK STEEL	100 x 200 mm	MAX. 4 kg
7410.003	MAGNETIC PICTURE HOOK STEEL	150 x 250 mm	MAX. 6 kg
7410.004	MAGNETIC PICTURE HOOK STEEL	200 x 300 mm	MAX. 12 kg

PARTITION WALL HOOKS

I.C.M. OBIMEX / ALCOA / SYPLA / SYSTEMFLEX / INTERSELECT PARTITION WALLS



HOOKS			
	WHITE	BLACK	
	WALL HOOK SYSTEMFLEX / INTERSELECT		
COLOUR	WHITE	BLACK	
MAX. CAPACITY	5 kg	5 kg	
ARTICLE NO.	9.4520	9.4521	

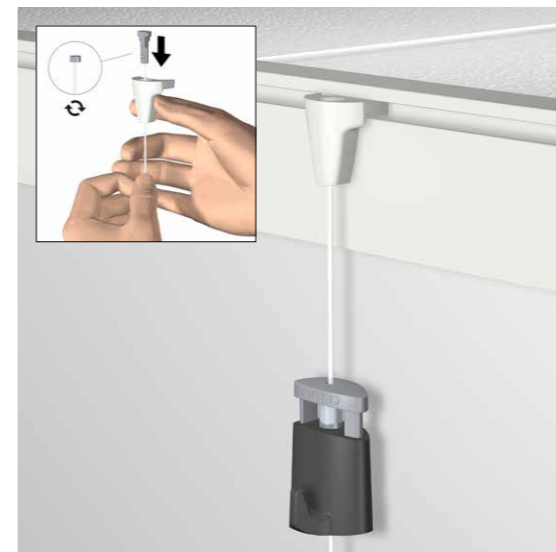

HOOKS			
	WHITE	BLACK	
	WALL HOOK ALCOA / SYPLA / OBIMEX		
COLOUR	WHITE	BLACK	
MAX. CAPACITY	5 kg	5 kg	
ARTICLE NO.	9.4522	9.4523	

1 mm					
TWISTER 1 mm					
	30.21150	TWISTER	1 mm	PERLON	150 cm
	30.21200	TWISTER	1 mm	PERLON	200 cm
	30.21300	TWISTER	1 mm	PERLON	300 cm

2 mm					
TWISTER 2 mm					
	09.23100	TWISTER	2 mm	PERLON	100 cm
	09.23150	TWISTER	2 mm	PERLON	150 cm
	09.23200	TWISTER	2 mm	PERLON	200 cm
	09.23250	TWISTER	2 mm	PERLON	250 cm
	09.23300	TWISTER	2 mm	PERLON	300 cm
	09.23500	TWISTER	2 mm	PERLON	500 cm

1 mm					
TWISTER 1 mm					
	30.21150	TWISTER	1 mm	PERLON	150 cm
	30.21200	TWISTER	1 mm	PERLON	200 cm
	30.21300	TWISTER	1 mm	PERLON	300 cm

2 mm					
TWISTER 2 mm					
	09.23100	TWISTER	2 mm	PERLON	100 cm
	09.23150	TWISTER	2 mm	PERLON	150 cm
	09.23200	TWISTER	2 mm	PERLON	200 cm
	09.23250	TWISTER	2 mm	PERLON	250 cm
	09.23300	TWISTER	2 mm	PERLON	300 cm
	09.23500	TWISTER	2 mm	PERLON	500 cm



FOR MORE HOOKS SEE PAGE 66.

For hanging on to partition walls

For areas where partitions are used to create quick and durable routes within (office) buildings, we have added two partition wall hooks to the range on the Obimex / Alcoa / Sypla and Systemflex / Interselect partitions. The wall hook is simply clicked into the desired location in the system wall and then used in combination with an Artiteq Twister Perlon hanging wire of 1 mm or 2 mm with picture hook. The wall hook has a maximum carrying capacity of 5 kg.

2 mm					
SLIDER ECONOMY 2 mm					
	9.4424	SLIDER ECONOMY	2 mm	PERLON	100 cm
	9.4425	SLIDER ECONOMY	2 mm	PERLON	150 cm
	9.4426	SLIDER ECONOMY	2 mm	PERLON	200 cm
	9.4427	SLIDER ECONOMY	2 mm	PERLON	250 cm
	9.4428	SLIDER ECONOMY	2 mm	PERLON	300 cm



FOR MORE HOOKS SEE PAGE 66.



ALL-IN-ONE
KITS

COMPACT
DESIGN
HIGH END

▶ **PICTURE HANGING SYSTEMS**

CLICK RAIL

The Click Rail flexible picture hanging system is available in a variety of all-in-one kits: economy, a Twister with a 15-kg hook and a Twister with a 20-kg Micro Grip hook. These retail packages contain the rail, mounting materials and instruction sheet, hanging wires and hooks, and are available in 2-m, 4-m and/or 6-m sets. The all-in-ones kits offer a complete solution and are ready for immediate onward sale.





ALL-IN-ONE CLICK RAIL ECONOMY

COMPLETE SET 2m

				
	CLICK RAIL WHITE PRIMER RAL 9010	FASTENING MATERIAL	END CAP	HOOK 4 kg + SLIDER ECONOMY 2 mm PERLON





ARTICLE NO. 9.5621

NEW COMPLETE SET 2m

				
	CLICK RAIL BLACK STRUCTURED	FASTENING MATERIAL	END CAP	HOOK 4 kg + SLIDER ECONOMY 2 mm PERLON

ARTICLE NO. 9.5635

COMPLETE SET 4m

				
	CLICK RAIL WHITE PRIMER RAL 9010	FASTENER MATERIAL	END CAP	HOOK 4 kg + SLIDER ECONOMY 2 mm PERLON

ARTICLE NO. 9.5627

COMPLETE SET 6m

				
	CLICK RAIL WHITE PRIMER RAL 9010	FASTENER MATERIAL	END CAP	HOOK 4 kg + SLIDER ECONOMY 2 mm PERLON

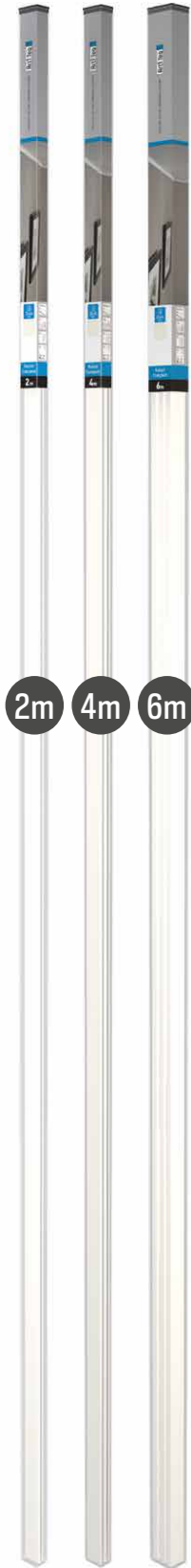

ARTICLE NO. 9.5629



CLICK RAIL



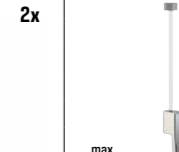

ALL-IN-ONE CLICK RAIL ECONOMY

COMPLETE SET 2m

				
	CLICK RAIL WHITE PRIMER RAL 9016	FASTENER MATERIAL	END CAP	HOOK 4 kg + SLIDER ECONOMY 2 mm PERLON





ARTICLE NO. 9.5623

COMPLETE SET 4m

				
	CLICK RAIL WHITE PRIMER RAL 9016	FASTENER MATERIAL	END CAP	HOOK 4 kg + SLIDER ECONOMY 2 mm PERLON



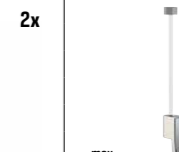

ARTICLE NO. 9.5628

COMPLETE SET 6m

				
	CLICK RAIL WHITE PRIMER RAL 9016	FASTENER MATERIAL	END CAP	HOOK 4 kg + SLIDER ECONOMY 2 mm PERLON

ARTICLE NO. 9.5630

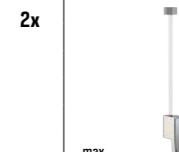

COMPLETE SET 2m

				
	CLICK RAIL ALU BRUSHED	FASTENER MATERIAL	END CAP	HOOK 4 kg + SLIDER ECONOMY 2 mm PERLON

ARTICLE NO. 9.5622

CLICK RAIL

ALL-IN-ONE CLICK RAIL TWISTER 15 KG HOOK

COMPLETE SET 2m				
	 1x 2m	 6x	 2x	 150 cm 2x max. 15 kg
ARTICLE NO.	9.7162	CLICK RAIL WHITE PRIMER RAL 9016	FASTENER MATERIAL	END CAP
HOOK 15 kg + TWISTER 2 mm PERLON				





COMPLETE SET 2m				
	 1x 2m	 6x	 2x	 150 cm 2x max. 15 kg
ARTICLE NO.	9.7161	CLICK RAIL WHITE RAL 9010	FASTENER MATERIAL	END CAP
HOOK 15 kg + TWISTER 2 mm PERLON				



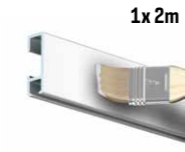

COMPLETE SET 2m				
	 1x 2m	 6x	 2x	 150 cm 2x max. 15 kg
ARTICLE NO.	9.7163	CLICK RAIL ALU BRUSHED	FASTENER MATERIAL	END CAP
HOOK 15 kg + TWISTER 2 mm PERLON				

COMPLETE SET 2m				
	 1x 2m	 6x	 2x	 150 cm 2x max. 15 kg
ARTICLE NO.	9.7164	CLICK RAIL ALU BRUSHED	FASTENER MATERIAL	END CAP
HOOK 15 kg + TWISTER 2 mm STEELWIRE				

CLICK RAIL

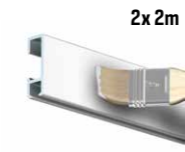
ALL-IN-ONE CLICK RAIL TWISTER MICRO GRIP 20 KG HOOK

COMPLETE SET 2m				
	 1x 2m	 6x	 2x	 150 cm 2x max. 20 kg
ARTICLE NO.	9.7130	CLICK RAIL WHITE PRIMER RAL 9016	FASTENER MATERIAL	END CAP
MICRO GRIP 2 mm + TWISTER 2 mm PERLON				

COMPLETE SET 4m				
	 2x 2m	 12x	 2x	 150 cm 3x max. 20 kg
ARTICLE NO.	9.7131	CLICK RAIL WHITE PRIMER RAL 9016	FASTENER MATERIAL	END CAP
MICRO GRIP 2 mm + TWISTER 2 mm PERLON				

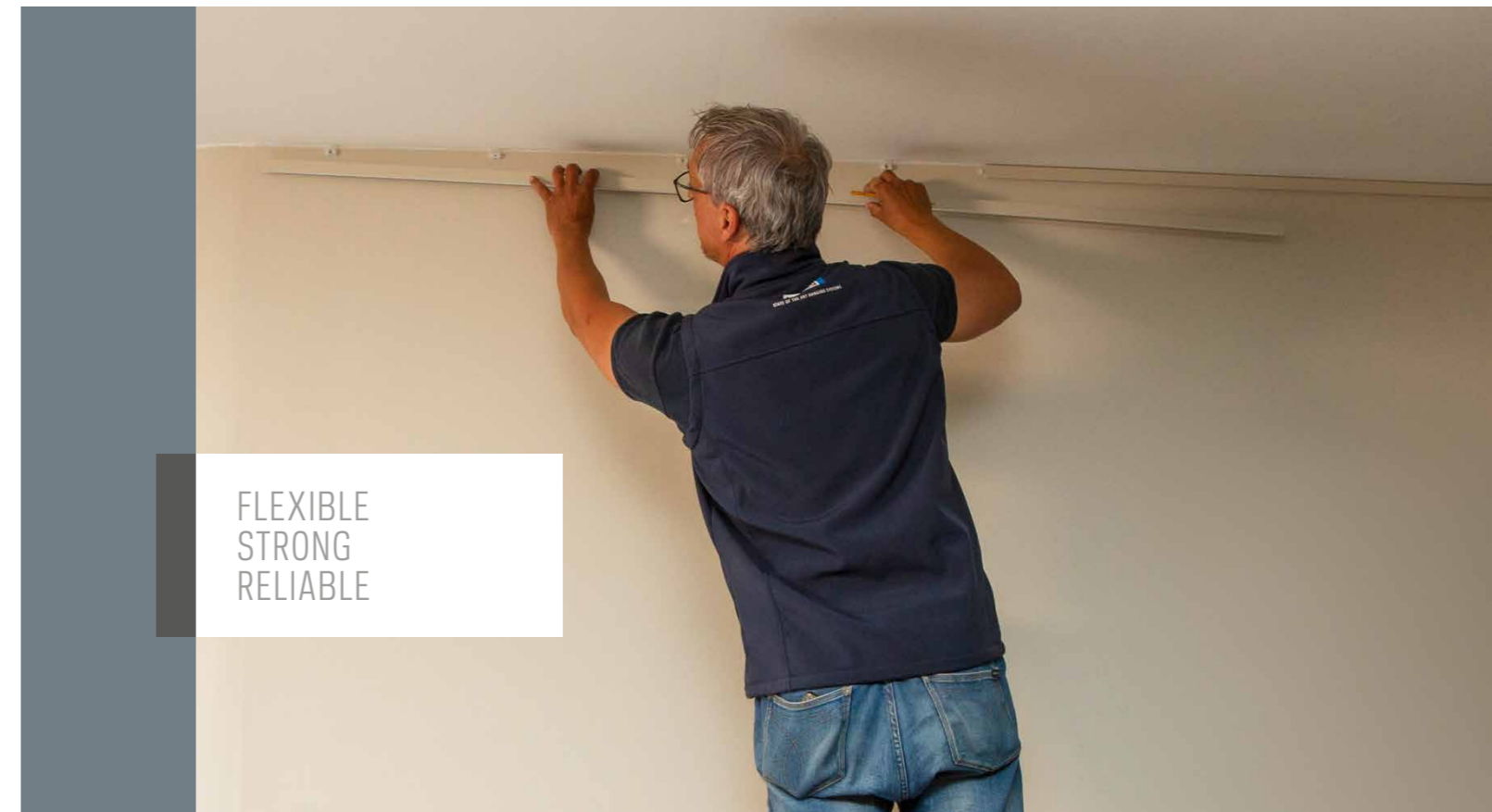

FLEXIBLE
STRONG
RELIABLE

▶ HANGING WIRES AND HOOKS

- WIDE RANGE OF HOOKS
- 4 KG TO 20 KG LOAD CAPACITY
- INVISIBLE PERLON HANGING WIRES
- ROBUST STEEL HANGING WIRES
- PERLON HANGING WIRES OF 1 MM AND 2 MM
- 1 MM AND 2 MM STEEL WIRES
- BLACK STEEL WIRE 1 MM

FLEXIBLE
SAFE
STRONG

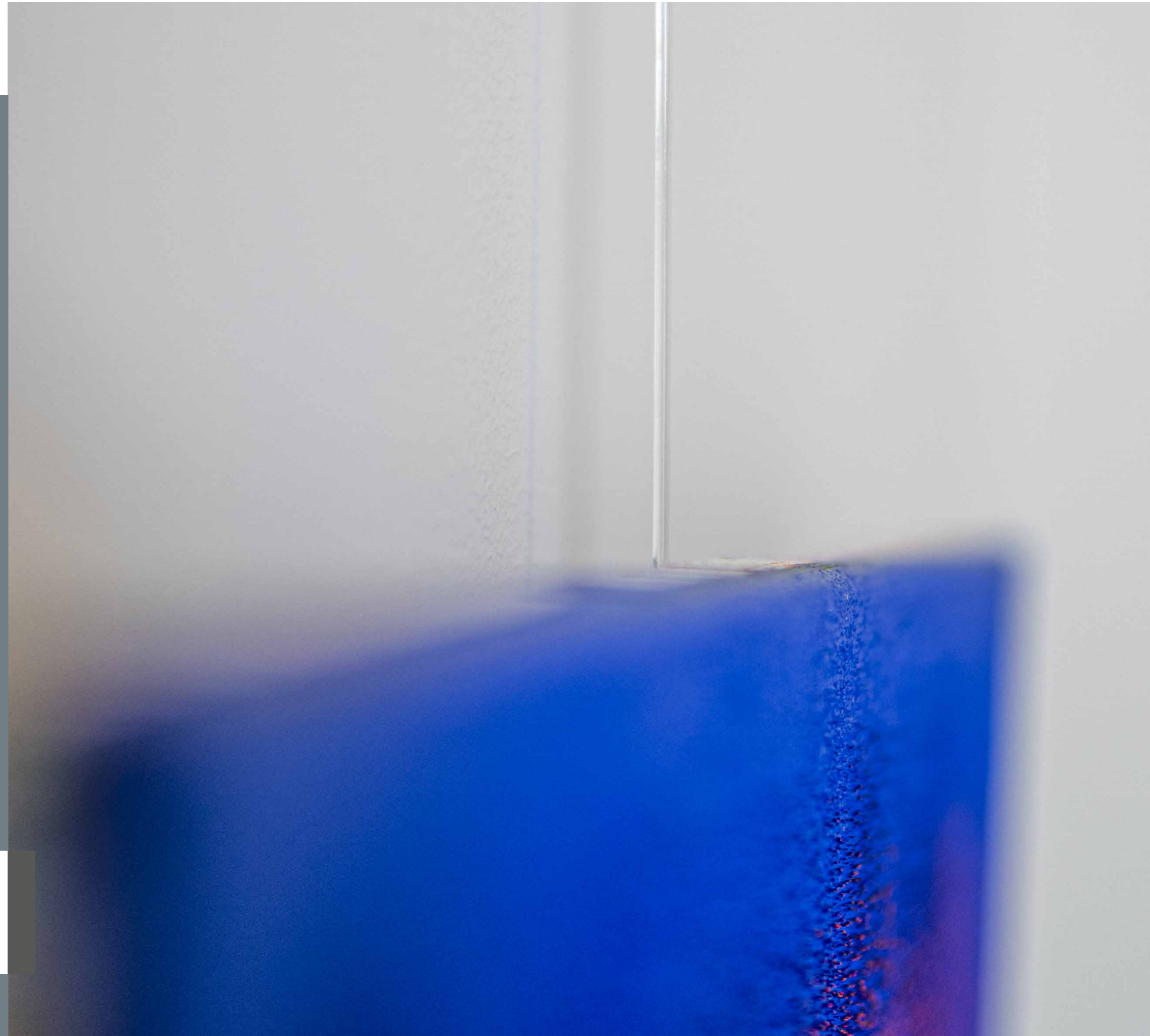

HANGING WIRES

In addition to the different hanging systems that Artiteq offers, there are (small) essential parts that are needed to actually hang the painting or wall decoration you want on the chosen rail. For example, there are various types of hanging wires and hooks to choose from, depending on your chosen rail and the weight of your painting or wall decoration.



TWISTER™

MAX.
20 KG

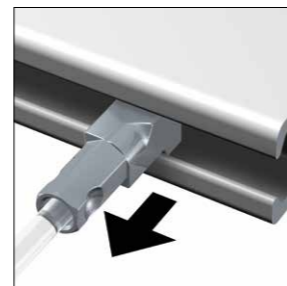
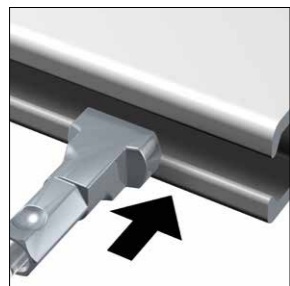

1

SIMPLE-SAFE-STRONG

Artiteq developed the Twister glider system for all its hanging rails. Twister offers the most Logical and user-friendly way to hook the hanging wire into the rail: insert, twist, click and you're done. Since the Twister may be clicked anywhere on the rail, you can hang a picture anywhere you like on the wall. You have the option of using Twister in perlon, steel wire or rods for all the Artiteq hanging systems. The perlon and steel hanging wires with the Twister mechanism are available in 1 or 2 mm thicknesses, and in lengths ranging from 100 to 500 cm.

TWISTER™

Twister is a European Registered Community Design.



HANGING WIRES

TWISTER™ CLIQ2FIX_{perlon}

MAX.
20 KG

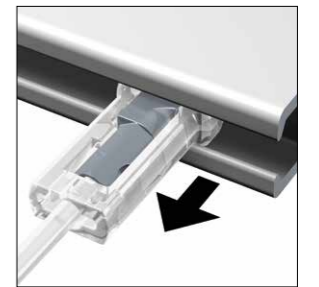
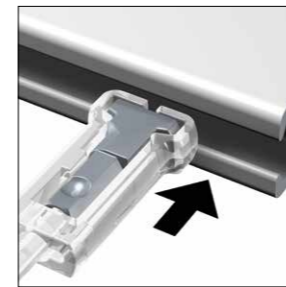

2

EXTRA EASE-OF-USE

Thanks to the development of the Twister Cliq2Fix perlon system, perlon cord now has an additional functionality when it comes to hanging pictures. The hanging wire equipped with the Twister Cliq2Fix system may be inserted in the rail, eliminating the risk of the perlon cord popping loose from the rail as a result of its recoiling effect. This makes it extra safe, and easy to slide into the rail. In other words, extra ease-of-use.



SOLID SLIDER

MAX.
20 KG

SLIDER ECONOMY

not visible in the rail

MAX.
15 KG

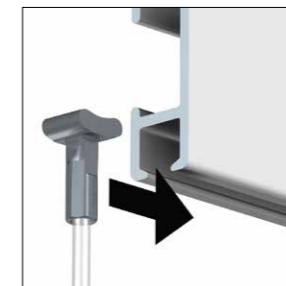
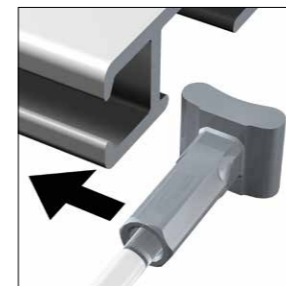

3

SLIDE INTO SIDE

Artiteq developed the Solid Slider system which attaches the hanging wire with glider via the side of the rail. This system is available for 2 mm perlon and 2 mm steel wire. The hanging wire may be freely slid into the hanging rail, yet may not be removed from the rail as easily. Hanging wires with the Solid Slider mechanism are available in lengths of 100, 150, 200, 250, 300 en 500 cm. A slanted stop system is available for slanted walls. This system makes it possible to use a flexible picture hanging system even with slanted walls, for example in a staircase.



HANGING WIRES



1 mm vs 2 mm hanging wires

Artiteq offers the Twister hanging wires in two different thicknesses; 1 mm and 2 mm. Both perlon and steel wire hanging wires are available in the two different thicknesses. The steel wire black hanging wires are only available in 1 mm.

The choice of choosing 1 mm hanging wires depends on one's own requirements. The smaller the diameter of the hanging wire, the less visible it is. Especially with the perlon hanging wires, the choice for 1 mm can be preferable. To hang a frame or wall decoration as invisible as possible.

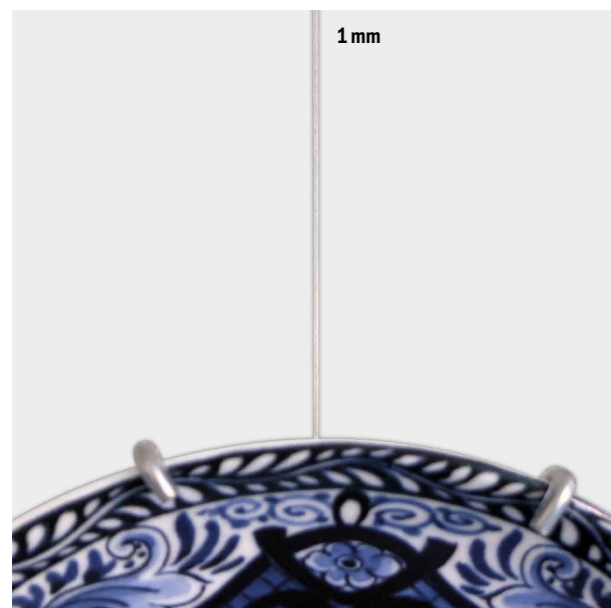
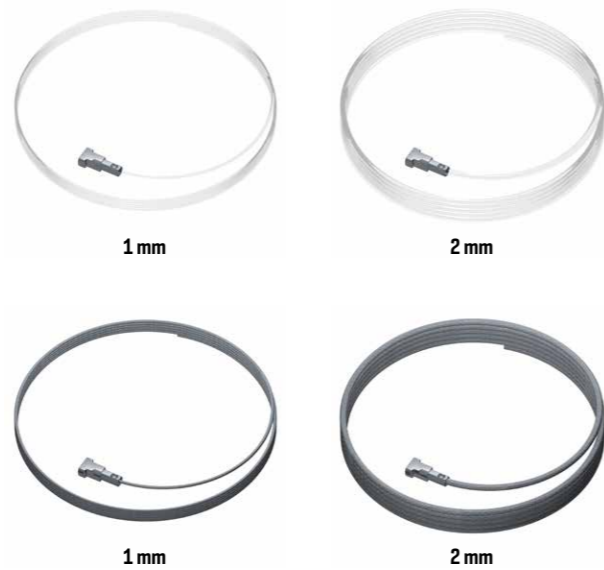

HANGING WIRES

1 mm						
TWISTER 1 mm						
	30.21150	TWISTER	1 mm	PERLON	5 kg	150 cm
	30.21200	TWISTER	1 mm	PERLON	5 kg	200 cm
	30.21300	TWISTER	1 mm	PERLON	5 kg	300 cm
	30.22150	TWISTER	1 mm	STEEL	10 kg	150 cm
	30.22200	TWISTER	1 mm	STEEL	10 kg	200 cm
	30.22300	TWISTER	1 mm	STEEL	10 kg	300 cm
	09.63150	TWISTER	1 mm	STEEL BLACK	10 kg	150 cm
	09.63200	TWISTER	1 mm	STEEL BLACK	10 kg	200 cm
	09.63300	TWISTER	1 mm	STEEL BLACK	10 kg	300 cm

2 mm						
TWISTER 2 mm						
	09.23100	TWISTER	2 mm	PERLON	20 kg	100 cm
	09.23150	TWISTER	2 mm	PERLON	20 kg	150 cm
	09.23200	TWISTER	2 mm	PERLON	20 kg	200 cm
	09.23250	TWISTER	2 mm	PERLON	20 kg	250 cm
	09.23300	TWISTER	2 mm	PERLON	20 kg	300 cm
	09.23500	TWISTER	2 mm	PERLON	20 kg	500 cm
	09.33100	TWISTER	2 mm	STEEL	20 kg	100 cm
	09.33150	TWISTER	2 mm	STEEL	20 kg	150 cm
	09.33200	TWISTER	2 mm	STEEL	20 kg	200 cm
	09.33250	TWISTER	2 mm	STEEL	20 kg	250 cm
	09.33300	TWISTER	2 mm	STEEL	20 kg	300 cm
	09.33500	TWISTER	2 mm	STEEL	20 kg	500 cm

2 mm						
TWISTER ROD 2 mm						
	9.4196	TWISTER	2 mm	ROD WHITE	20 kg	100 cm
	9.4198	TWISTER	2 mm	ROD WHITE	20 kg	200 cm

2 mm						
TWISTER CLIQ2FIX PERLON 2 mm						
	09.13100	TWISTER CLIQ2FIX	2 mm	PERLON	20 kg	100 cm
	09.13150	TWISTER CLIQ2FIX	2 mm	PERLON	20 kg	150 cm
	09.13200	TWISTER CLIQ2FIX	2 mm	PERLON	20 kg	200 cm
	09.13250	TWISTER CLIQ2FIX	2 mm	PERLON	20 kg	250 cm
	09.13300	TWISTER CLIQ2FIX	2 mm	PERLON	20 kg	300 cm

2 mm						
SOLID SLIDER 2 mm						
	08.23100	SOLID SLIDER	2 mm	PERLON	20 kg	100 cm
	08.23150	SOLID SLIDER	2 mm	PERLON	20 kg	150 cm
	08.23200	SOLID SLIDER	2 mm	PERLON	20 kg	200 cm
	08.23250	SOLID SLIDER	2 mm	PERLON	20 kg	250 cm
	08.23300	SOLID SLIDER	2 mm	PERLON	20 kg	300 cm
	08.23500	SOLID SLIDER	2 mm	PERLON	20 kg	500 cm
	08.43100	SOLID SLIDER	2 mm	STEEL	20 kg	100 cm
	08.43150	SOLID SLIDER	2 mm	STEEL	20 kg	150 cm
	08.43200	SOLID SLIDER	2 mm	STEEL	20 kg	200 cm
	08.43250	SOLID SLIDER	2 mm	STEEL	20 kg	250 cm
	08.43300	SOLID SLIDER	2 mm	STEEL	20 kg	300 cm
	08.43500	SOLID SLIDER	2 mm	STEEL	20 kg	500 cm



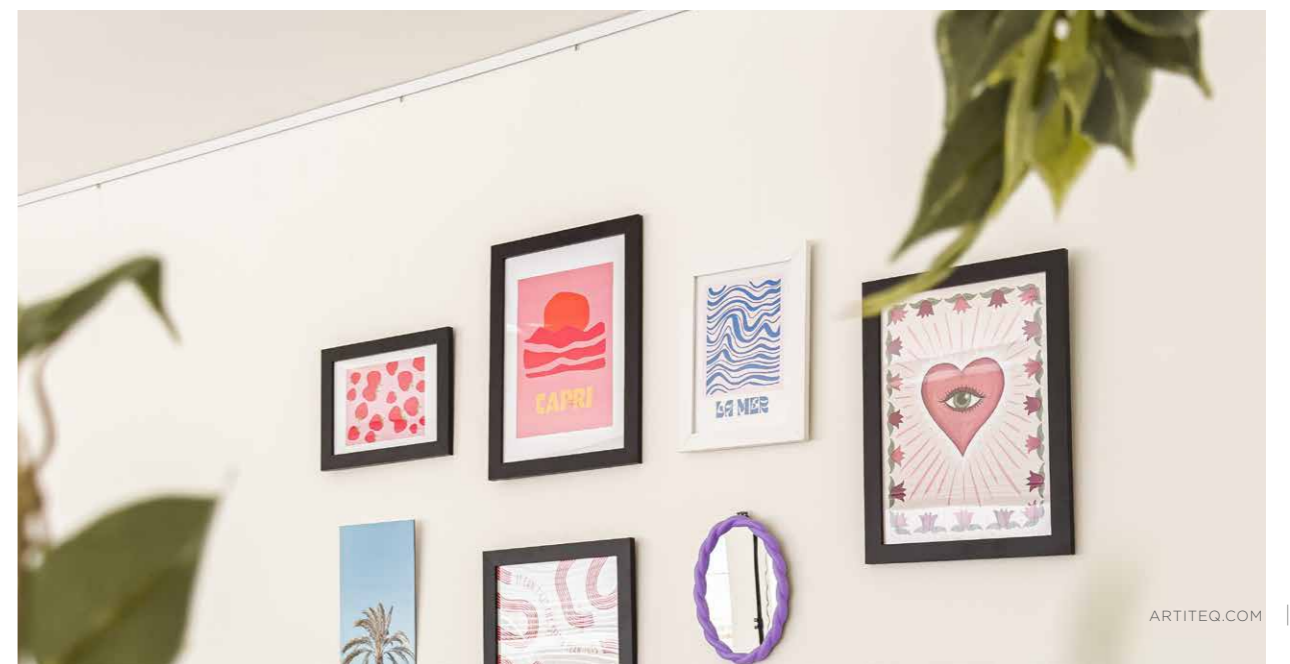







2 mm						
SLIDER ECONOMY 2 mm						
	9.4424	SLIDER ECONOMY	2 mm	PERLON	15 kg	100 cm
	9.4425	SLIDER ECONOMY	2 mm	PERLON	15 kg	150 cm
	9.4426	SLIDER ECONOMY	2 mm	PERLON	15 kg	200 cm
	9.4427	SLIDER ECONOMY	2 mm	PERLON	15 kg	250 cm
	9.4428	SLIDER ECONOMY	2 mm	PERLON	15 kg	300 cm



HOOKS & COMPATIBILITY

Depending on the weight of a frame or other wall decoration, the right picture hook must be selected. The wide product range offers hooks with maximum load capacities varying from 4 kg to 20 kg.

						
		30.41200 20 kg AUTO GRIP	30.41250 20 kg AUTO GRIP	30.41100 10/5 kg AUTO GRIP	9.4264 15 kg AUTO GRIP	9.4261 15 kg AUTO GRIP
		LOCK		LOCK		
 TWISTER 1 mm PERLON 150 / 200 / 300 cm				✓		
 TWISTER 1 mm STEELWIRE 150 / 200 / 300 cm				✓		
 TWISTER 1 mm STEELWIRE BLACK 150 / 200 / 300 cm				✓		
 TWISTER 2 mm PERLON 100 / 150 / 200 250 / 300 / 500 cm		✓	✓		✓	✓
 TWISTER 2 mm STEELWIRE 100 / 150 / 200 250 / 300 / 500 cm		✓	✓		✓	✓
 TWISTER 2 mm 2 mm ROD WHITE 100 / 200 cm		✓	✓			✓
 TWISTER CLIQ2FIX 2 mm PERLON 100 / 150 / 200 250 / 300 cm		✓	✓		✓	✓
 SOLID SLIDER 2 mm PERLON* 100 / 150 / 200 250 / 300 / 500 cm insert from the side		✓	✓		✓	✓
 SOLID SLIDER 2 mm STEELWIRE* 100 / 150 / 200 250 / 300 / 500 cm insert from the side		✓	✓		✓	✓

						
		9.4208 10 kg MANUAL	9.4219 7 kg MANUAL	9.4209 7 kg MANUAL	9.4207 5 kg MANUAL	9.4205 4 kg MANUAL
 TWISTER 2 mm PERLON 100 / 150 / 200 250 / 300 / 500 cm		✓	✓	✓	✓	✓
 TWISTER 2 mm ROD WHITE 100 / 200 cm					✓	
 TWISTER CLIQ2FIX 2 mm PERLON 100 / 150 / 200 250 / 300 cm		✓	✓	✓	✓	✓
 SOLID SLIDER 2 mm PERLON* 100 / 150 / 200 250 / 300 / 500 cm insert from the side		✓	✓	✓	✓	✓

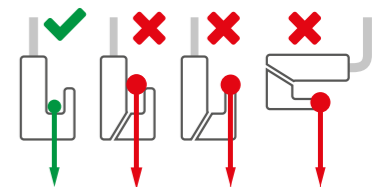

The maximum weight carrying capacity of a picture hook is only valid when the frame is correctly applied to the hook. This illustration shows how to correctly charge the picture hook.

MICRO GRIP



Micro Grip represents the newest generation of hooks. A high-quality plastic reinforced with fibreglass was chosen for this hook, leading to a 70% reduction in the use of materials compared with previous generations of hooks. In addition to the ecological advantages, the hook is extremely lightweight as a result, and very easy to use. The **Micro Grip** technology has been developed and patented by Artiteq. To guarantee the quality of the **Micro Grip** hooks, Artiteq has developed quality assurance procedures together with TÜV Nederland. The execution is under supervision of TÜV Nederland.



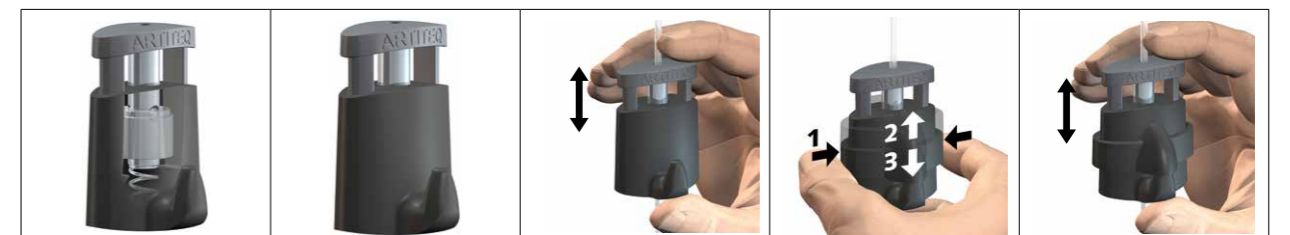



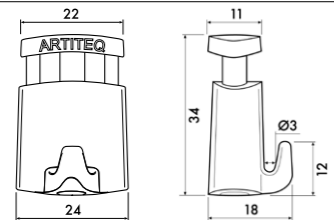

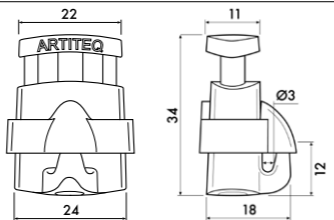
- LIGHTWEIGHT
- STRONG (20 kg)
- ERGONOMIC

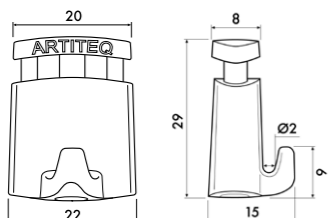

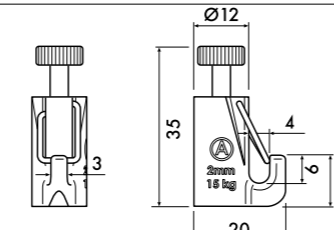



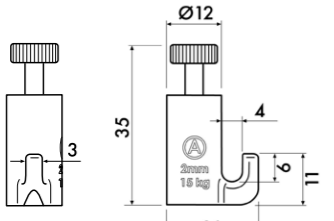

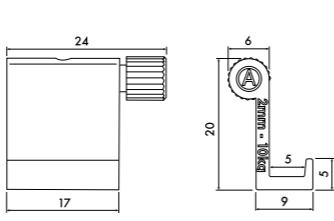
HOOKS

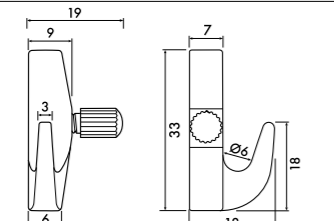
  <p>30.41200 20 kg AUTO GRIP</p>	  <p>30.41250 20 kg AUTO GRIP</p>
--	---

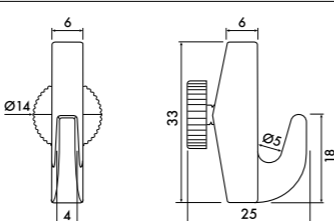
  <p>30.41100 10/5 kg AUTO GRIP</p>	  <p>9.4264 15 kg AUTO GRIP</p>
--	---

  <p>9.4261 15 kg AUTO GRIP</p>	  <p>9.4208 10 kg MANUAL</p>
---	---

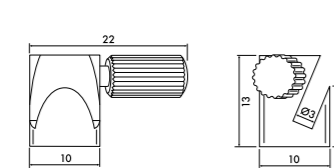
  <p>9.4219 7 kg MANUAL</p>	  <p>9.4209 7 kg MANUAL</p>
--	---

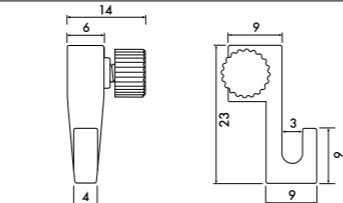
  <p>9.4207 5 kg MANUAL</p>	  <p>9.4205 4 kg MANUAL</p>
--	---



COMBINATIONS

A picture hanging system comprises the following elements: **rail**, **hanging wire** and **hanging hook**. Artiteq guarantees the functionality of the products because it carefully coordinates the various elements of a picture hanging system. The quality can only be guaranteed when original (Artiteq) products are combined correctly. The guarantee is null and void if there are combinations other than with the correct Artiteq products. A frame or canvas will always hang more steadily if **2 hanging wires** are used.

The weight of the frame determines the choice of the hook and wire, in combination with the maximum weight carrying capacity of one metre of the rail.

INCORRECT COMBINATIONS

CORRECT COMBINATIONS

HANGING SETS

HANGING SETS 1 mm		HANGING SETS 2 mm				
max. 10 kg	max. 5 kg	max. 20 kg	max. 4 kg	max. 7 kg	max. 15 kg	max. 5 kg
TWISTER 1 mm STEELWIRE 150 cm + MICRO GRIP 1 mm (10 kg)	TWISTER 1 mm PERLON 150 cm + MICRO GRIP 1 mm (5 kg)	TWISTER 2 mm PERLON 150 cm + MICRO GRIP 2 mm (20 kg)	TWISTER 2 mm PERLON 150 cm + HOOK 9.4205 (4 kg)	TWISTER 2 mm PERLON 150 cm + HOOK 9.4209 (7 kg)	TWISTER 2 mm PERLON 150 cm + HOOK 9.4261 (15 kg)	TWISTER 2 mm PERLON 150 cm + HOOK 9.4207 (5 kg)
HANGING SET	HANGING SET	HANGING SET	HANGING SET	HANGING SET	HANGING SET	HANGING SET
30.42150	30.42100	30.42200	9.6670	9.6672	9.6674	9.6671

HANGING SETS 2 mm			STOPPER SET SLANTING WALLS	
max. 4 kg	max. 7 kg	max. 5 kg	max. 4 kg	
SLIDER ECONOMY 2mm 150 cm + HOOK 4kg (9.4205)	SLIDER ECONOMY 2mm 150 cm + HOOK 7kg (9.4209)	SLIDER ECONOMY 2mm 150 cm + HOOK 5kg (9.4207)	SOLID SLIDER 2 mm PERLONWIRE 150 cm + HOOK 4kg (9.4205) + STOPPER SLANTING WALLS	STOPPER SLANTING WALLS
HANGING SET	HANGING SET	HANGING SET	HANGING SET	
9.9004	9.4402	9.4400	9.6645	9.4235

installation video

MISCELLANEOUS

TWISTER HOOK

TWISTER HOOK	
SIZE	35x4x15 mm
MAX. CAPACITY	MAX. 1 kg
ARTICLE NO.	9.4510

COMPATIBLE WITH ALL ARTITEQ PICTURE HANGING SYSTEMS

The Twister Hook completely replaces the hanging wire and hook. This plastic hook can provide an economical and practical solution for hanging light panels, artwork or, for example, a light string or garland for decoration, in combination with a picture hanging system. The maximum load capacity of the Twister Hook is 1 kg. The Twister Hook can be clicked into the rail at any position; turn in, click in and done.



MISCELLANEOUS

LOOP MAKER

LOOP MAKER		HANGING SET 2x TWISTER PERLON 2 mm 150 cm + LOOP MAKER	
SIZE	0,5x10 mm		
MAX. CAPACITY	MAX. 1 kg		
ARTICLE NO.	9.4218		9.6644

COMPATIBLE WITH ALL PERLON WIRES 2 mm, SEE PAGE 64

The Loop Maker offers a solution for hanging objects if a hook cannot be used. As it is possible to create a loop with the 2-mm perlon hanging wire, it is possible to hang much more than just a picture frame!



MISCELLANEOUS

PICTURE MOUSE



	PICTURE MOUSE WHITE	PICTURE MOUSE STEEL
	150 cm	150 cm
ARTICLE NO.	7805.014	7805.016
COMPATIBLE WITH ALL ARTITEQ PICTURE HANGING SYSTEMS		

Picture Mouse is a handy and original hanging cord for displaying several documents, such as cards and photos. It can also be used as a 'solo' version rather than as part of a picture hanging system. The Picture Mouse Solo system is simple to install by mounting the wall clip to the wall. The steel Picture Mouse cord can be inserted and is hung from the wall clip.

PICTURE MOUSE SOLO (COMPLETE SET)

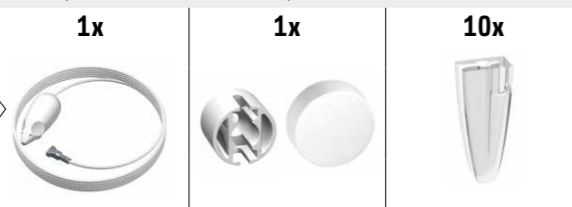

	1x	1x	10x
PICTURE MOUSE SOLO	PICTURE MOUSE WHITE	WALL CLIP + COVER (WITH FASTENER MATERIAL)	PICTURE CLIP TRANSPARENT
	150 cm		
ARTICLE NO.	7840.100		

As well as the transparent clips, magnets can also be used on the Picture Mouse cord. The Mouse Magnets, available in white or in colour, combine perfectly with the Picture Mouse cord.

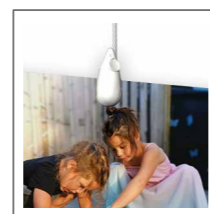

PICTURE CLIP TRANSPARENT	MOUSE MAGNETS WHITE	MOUSE MAGNETS COLOUR
ARTICLE NO. 7805.007	7430.020	7430.010

in combination with a picture hanging system



solo



▶ FRAME ACCESSORIES



SIMPLE
SAFE
STRONG

Credits: @rohouseproud

ARTITEQ BACK FRAME HANGING SYSTEM



A **safe** and **solid** solution to hang printed panels.
 Adds **depth** and **shadow** between panel and wall.
 Adds **rigidity** to **flexible** panels made of aluminium (Dibond), forex or acrylic.

The Back Frame Hanging System is a mounting system especially for thin and flexible panels made of aluminium, forex or acrylic. It helps to stiffen the panel, while mounting is easy and safe. The leveling system provided by the Back Frame Corners is particularly convenient for the mounted panel allowing adjustment for the panel up to 6 mm. The panel will always be straight without drilling new holes.

The Back Frame Hanging System is available in 8 mm and 15 mm profiles, both in the versions alu mill finish and silver anodised.

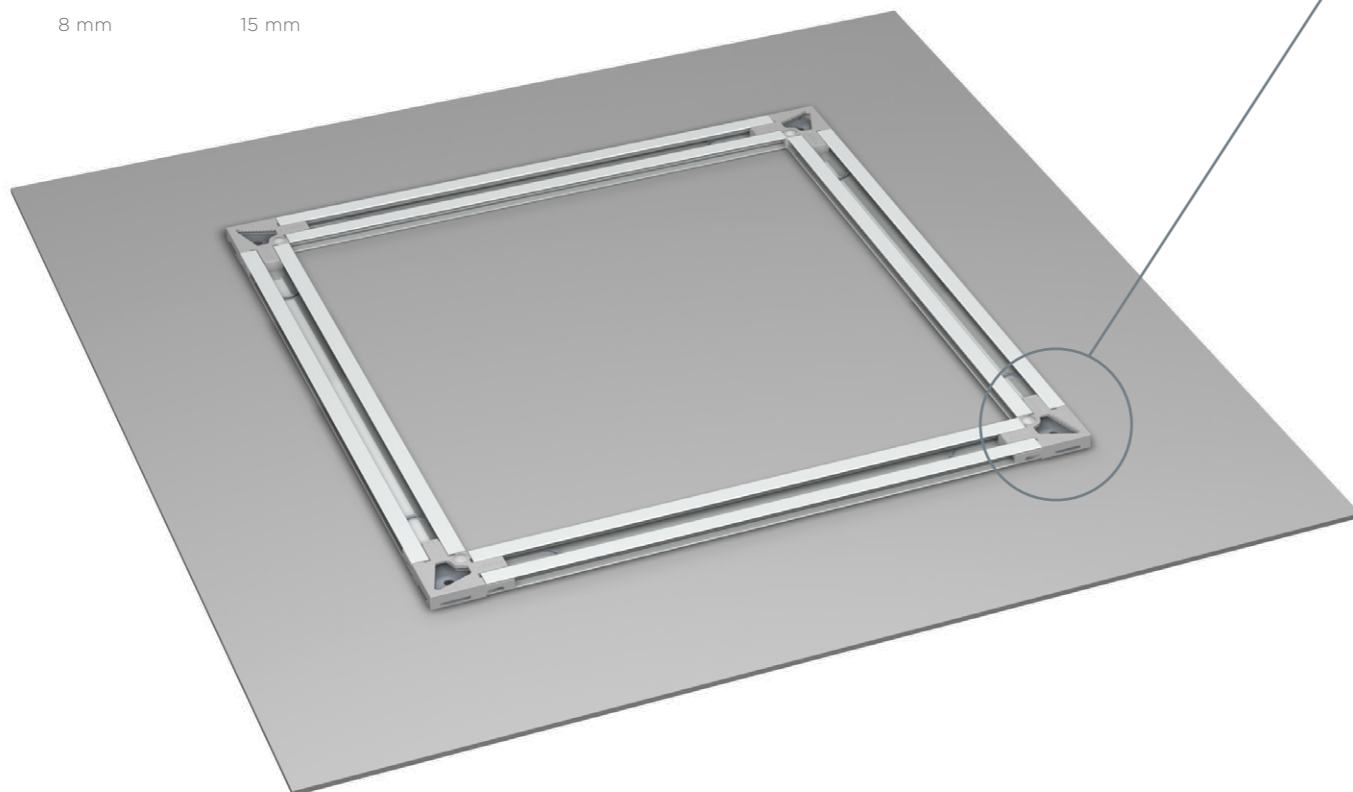
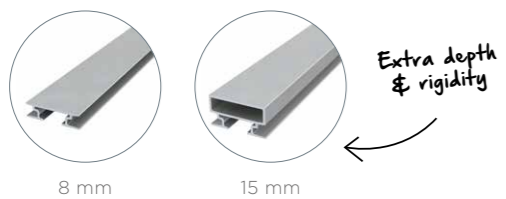

ARTITEQ BACK FRAME HANGING SYSTEM



1. WALL PROTECTION INCORPORATED

Wall protection is incorporated in the Power Corners.

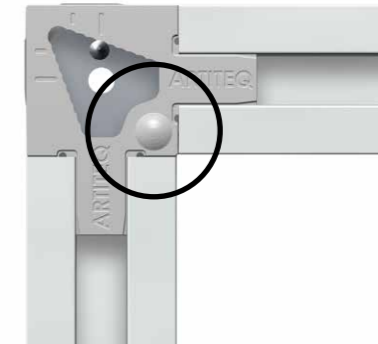

2. LESS TAPE, BETTER LOAD CAPACITY

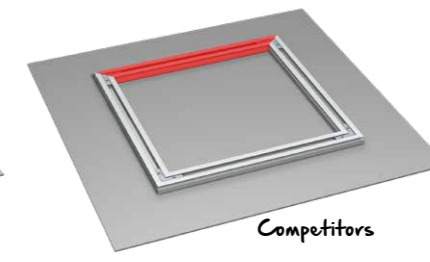
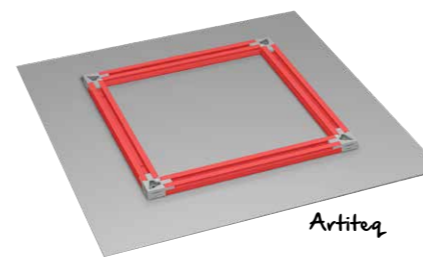

Rigid fixing thanks to steel spring!



Power Corners enable equal weight distribution because of rigid fixing thanks to steel spring in square-cut profiles instead of mitre-cut profiles.

3. EASY HANGING: 3 OPTIONS

The Artiteq Back Frame Power Corners provide 3 easy ways of hanging a printed panel : Fixed (1), Secured (2) and Flexible (3).

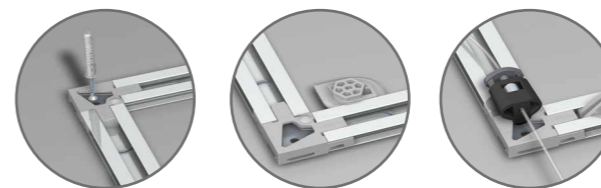

4. NO EXTRA ACCESSORIES NEEDED

The printed panel is hung using the Power Corners, no extra accessories needed.

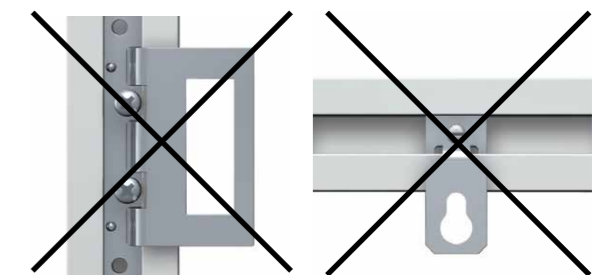

ARTITEQ BACK FRAME HANGING SYSTEM



The Back Frame Hanging System is available in 8 mm and 15 mm profiles, both in the versions alu mill finish and silver anodised.

BACK FRAME HANGING SYSTEM RAIL 8mm

05.16300	05.16301	05.16010
BACK FRAME RAIL 8 mm 300 cm ALU BRUTE	BACK FRAME RAIL 8 mm 300 cm SILVER ANODISED	BACK FRAME POWER CORNER 8 mm (SET OF 4)

BACK FRAME HANGING SYSTEM RAIL 15mm

05.17300	05.17301	05.17010
BACK FRAME RAIL 15 mm 300 cm ALU BRUTE	BACK FRAME RAIL 15 mm 300 cm SILVER ANODISED	BACK FRAME POWER CORNER 15 mm (SET OF 4)

BACK FRAME HANGING SYSTEM ADDITIONS

05.16050	05.16055	05.16030	05.16040	05.16060
TAPE 3M 12 mm 33 M	3M VHB CLEANING TISSUES	BACK FRAME SECURITY KEY	BACK FRAME FLEX BUMPER	BACK FRAME SECURITY CLIP (4 CLIPS, 4 PLUGS, 4 SCREWS)

SET* BACK FRAME HANGING SYSTEM ON LENGTH INCLUDING 3M TAPE MOUNTED

	SET 2x BACK FRAME RAIL 8 MM 344 MM ALU BRUTE (40CM)	SET 2x BACK FRAME RAIL 8 MM 444 MM ALU BRUTE (50CM)	SET 2x BACK FRAME RAIL 8 MM 544 MM ALU BRUTE (60CM)	SET 2x BACK FRAME RAIL 8 MM 644 MM ALU BRUTE (70CM)	
	05.16725	05.16726	05.16735	05.16745	
	SET 2x BACK FRAME RAIL 8 MM 744 MM ALU BRUTE (90CM)	SET 2x BACK FRAME RAIL 8 MM 844 MM ALU BRUTE (90CM)	SET 2x BACK FRAME RAIL 8 MM 944 MM ALU BRUTE (100CM)	SET 2x BACK FRAME RAIL 8 MM 1044 MM ALU BRUTE (110CM)	
	05.16746	05.16755	05.16756	05.16765	

* SET DOES NOT INCLUDE POWER CORNERS 8MM

ARTITEQ BACK FRAME HANGING SYSTEM

A For the correct sizing and positioning of the Back Frame Hanging System, we recommend placing the profiles at 100 mm from each side of the printed panel. When glueing the profiles to the back of the printed panels, we recommend using 3M tape (article number 05.16050).

B The 8-mm and 15-mm profiles for the Back Frame Hanging System can also be mitre-cut. The profiles will fit with a wide range of accessories available on the market.

C We recommend using 3M tape (general advice 3M: 25 cm²/kg) for printed panels made of aluminium, hard-foam, forex, acryl and glass. The below table applies when Back Frame Hanging System profiles are applied at max. 100 mm from each of the sides of the printed panel (see A). The table applies for panels with a maximum total weight of 30 kg and a minimum size of 400 x 400 mm.

MATERIAL	THICKNESS	TAPE	FOR SURFACES
Dibond	3-6 mm	Single tape 12 mm	Up to 4 m ²
Forex	3-5 mm	Single tape 12 mm	Up to 4 m ²
Acryl	3-5 mm	Single tape 12 mm	Up to 4 m ²
Glass	6 mm	Double tape 24 mm	Up to 2 m ²



BEHIND WOODEN FRAMES

When hanging wooden frames or paintings, it is important to use a good frame hanger that is compatible with Artiteq's hanging systems. A frame hanger is an important component for correctly hanging a frame or painting. Artiteq has some frame hangers for a wooden frame or painting.



FRAME HANGER
1-1,5 mm STEELWIRE
(MAX. 10 kg)

ARTICLE NO. 7805.055



FRAME HANGER
1,5-2 mm STEELWIRE
(MAX. 15 kg)

ARTICLE NO. 7805.050



FRAME HANGER
FOR USE WITH WOOD

ARTICLE NO. 808.650



SET FRAME
HANGERS
L&R

ARTICLE NO. 808.600

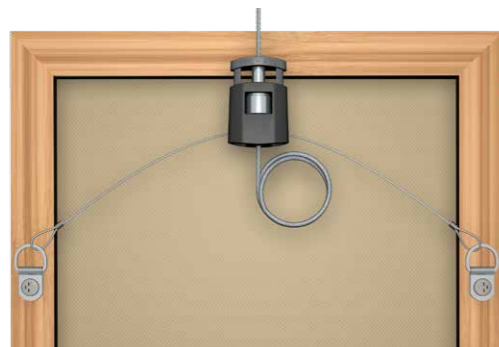

SET D-RING
(1 SET) 5 kg

ARTICLE NO. 4055



D-RING HANGER
5 kg

ARTICLE NO. 805.249



SCREW D-RING

ARTICLE NO. 9.4911

SPOOL



STEELWIRE
1 mm SPOOL 1x19

ARTICLE NO. 100 m 9.4904

ARTICLE NO. 500 m -



STEELWIRE
1,2 mm SPOOL 1x19

ARTICLE NO. 100 m 9.4955

ARTICLE NO. 500 m -



STEELWIRE
1,5 mm SPOOL 1x19

ARTICLE NO. 100 m 9.4990

ARTICLE NO. 500 m -



PERLON
2 mm SPOOL

ARTICLE NO. 100 m 9.4404

ARTICLE NO. 500 m 9.4421S



PRESSING NIPPLE
1-1,2 mm

ARTICLE NO. 9.4905



WIRE CLAMP
1,5 mm ALU

ARTICLE NO. 9.4430



WIRE CLAMP
2 mm ALU

ARTICLE NO. 9.4431



HANGING NIPPLE

ARTICLE NO. 9.4211

BEHIND WOODEN FRAMES



SECURITY SET

ARTICLE NO. 4054



SET FOLDING EYE
(12 PIECES)

ARTICLE NO. 4057

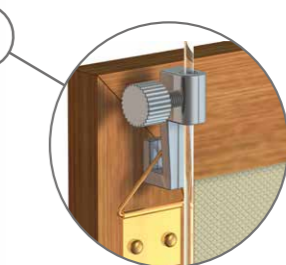

SET FRAMEHOOK +
HANGING
(12 PIECES)

ARTICLE NO. 4056

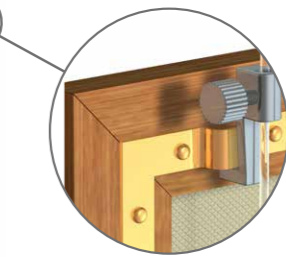

SET WALL HOOKS
(12 PIECES)

ARTICLE NO. 4059



SET CONCRETE
HOOKS (4 PIECES)

ARTICLE NO. 4058



BEHIND ALUMINIUM FRAMES AND DIBOND/FOREX/PLEXIGLASS PANELS

There is also a frame hanger for aluminum frames. This hanger is attached to the back of the frame and can be used in combination with an Artiteq picture hanging system and hanging wires. For hanging a panel made of Dibond, Forex or Plexiglas, Artiteq has Dibond Hangers. These Dibond Hangers are available in 4 different sizes, each with its own maximum load-bearing capacity.

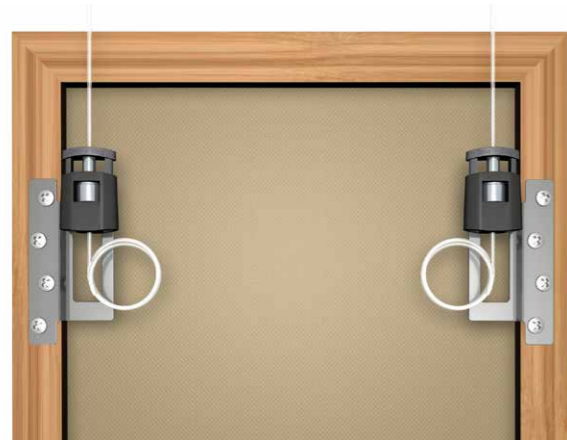

FRAME HANGER FOR USE WITH ALUMINIUM

ARTICLE NO. 808.720



DIBOND HANGER

WALL BRACKET SUPPORT DIBOND HANGER METAL

ARTICLE NO. 809.505 45 X 45 mm (MAX. 1 KG)

809.020

ARTICLE NO. 809.520 70 X 70 mm (MAX. 2 KG)

ARTICLE NO. 809.530 100 X 100 mm (MAX. 4 KG)

ARTICLE NO. 809.540 100 X 200 mm (MAX. 8 KG)



SPACERS TRANSPARENT, SELF-ADHESIVE

ARTICLE NO. 809.001 12,5 x 12,5 x 5,7 mm



SPACERS FOAM, SELF-ADHESIVE

809.002 20 x 20 x 15 mm

BEHIND ALUMINIUM FRAMES AND DIBOND/FOREX/PLEXIGLASS PANELS

NEW



SET DIBOND HANGER

SET DIBOND HANGER

ARTICLE NO. 9.6894 SET DIBOND HANGER 1ST 45 x 45mm (1KG)

ARTICLE NO. 9.6895 SET DIBOND HANGER 1ST 70 x 70mm (2KG)

ARTICLE NO. 9.6896 SET DIBOND HANGER 1ST 100 x 100mm (4KG)

ARTICLE NO. 9.6897 SET DIBOND HANGER 1ST 100 x 200mm (8KG)

NEW







* WALL BRACKET ONLY IN COMBINATION WITH DIBOND HANGERS 809.530 (100 X 100MM) AND 908.540 (100 X 200 MM).

MISCELLANEOUS ACCESSORIES

Tiles and plates can also be hung in combination with an Artiteq picture hanging system. Often a tile or a decorative plate does not have a hanging point on the back. With this Tile Hanger and Plate Hanger, however, it is possible to hang them on the wall.

Frames can tilt/hang forward when using a picture hanging system. To reduce the forward tilt this Tilt Reducer can be used. This can only be attached to a wooden frame.

MISCELLANEOUS

					
PLATE HANGER WHITE (1X) 19-28 cm (MAX. 1 kg)	TILE HANGER (1X) 32 mm (MAX. 200 GR)	SET TILE HANGER (4 PIECES)	SET ADHESIVE HANGER 30 mm	TILT REDUCER 11x5x29 mm	SET TILT REDUCER (2 STUKS)
ARTICLE NO. 807.025	808.130	4051		805.300	9.6635

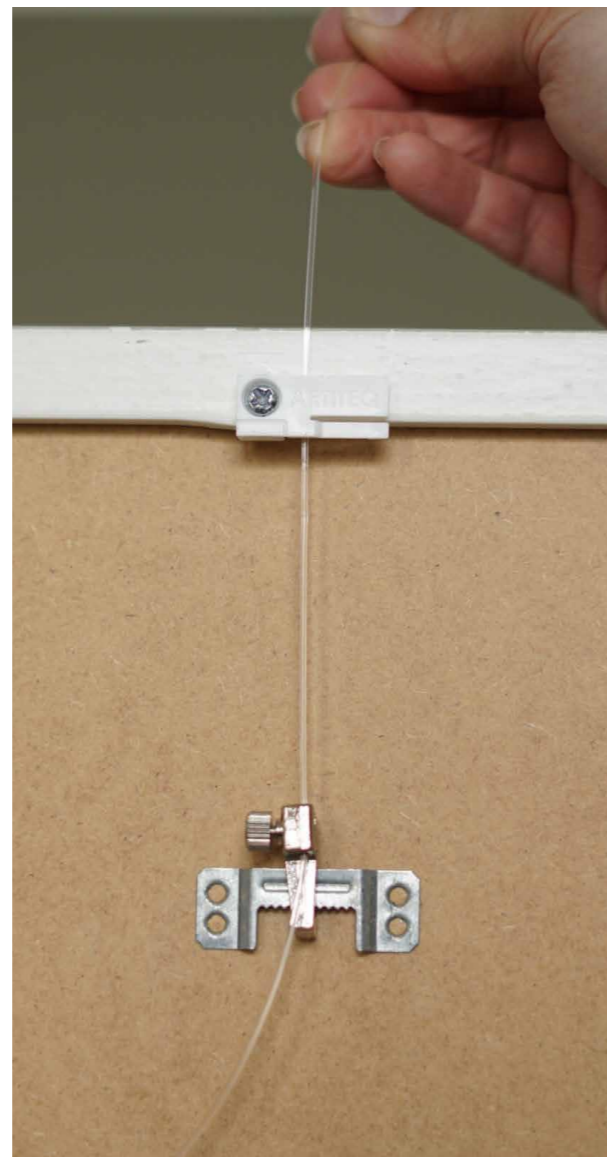
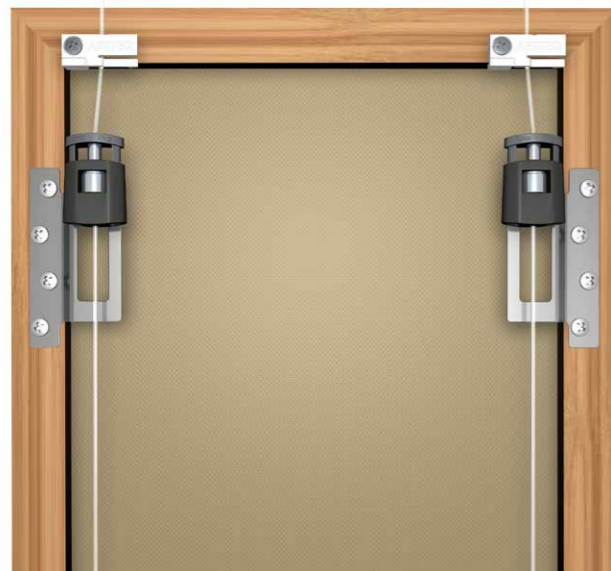

▶ DISPLAY HANGING SYSTEMS

CABLE SYSTEMS

- OPTIMAL PRESENTATION OF DOCUMENTS, PRODUCTS AND SERVICES
- SIMPLE AND QUICK CHANGE OF CONTENT
- FLEXIBLE IN RAIL OR DIRECT MOUNTING ON WALL OR CEILING

MULTIFUNCTIONAL
SAFE
STRONG



DISPLAY IT LED FLEX

Make a statement with LED panels

This cable system, with LED lighting, enables documents, products and services to be displayed perfectly. It is ideal as a display system in display cabinets, where the information can stand out both day and night! The rail can be mounted to the wall or the ceiling. The adaptors can be twisted into and out of the rail in an instant, allowing flexible use of the system.



installation video

RAIL

RAIL BLACK*	RAIL BLACK*	HANGING SET	POWER CONNECTOR SET	RAIL COVER CAP BLACK
183 cm	300 cm	2x 300 cm		82/37 x 82 mm
ARTICLE NO. 7720.183	7720.300	7710.010	7710.020	7740.019

*RAIL INCLUDES FASTENER MATERIAL AND END CAPS

DISPLAY IT LED FIXED

An eye-catcher on the wall

The Display It LED Fixed cable system is mounted to the wall or ceiling and because of the LED panels, this creates a striking display. Like the Flex version, the Display It LED Fixed can be used in display cabinets or in other places in a building. The content of the panels can be changed in no time.

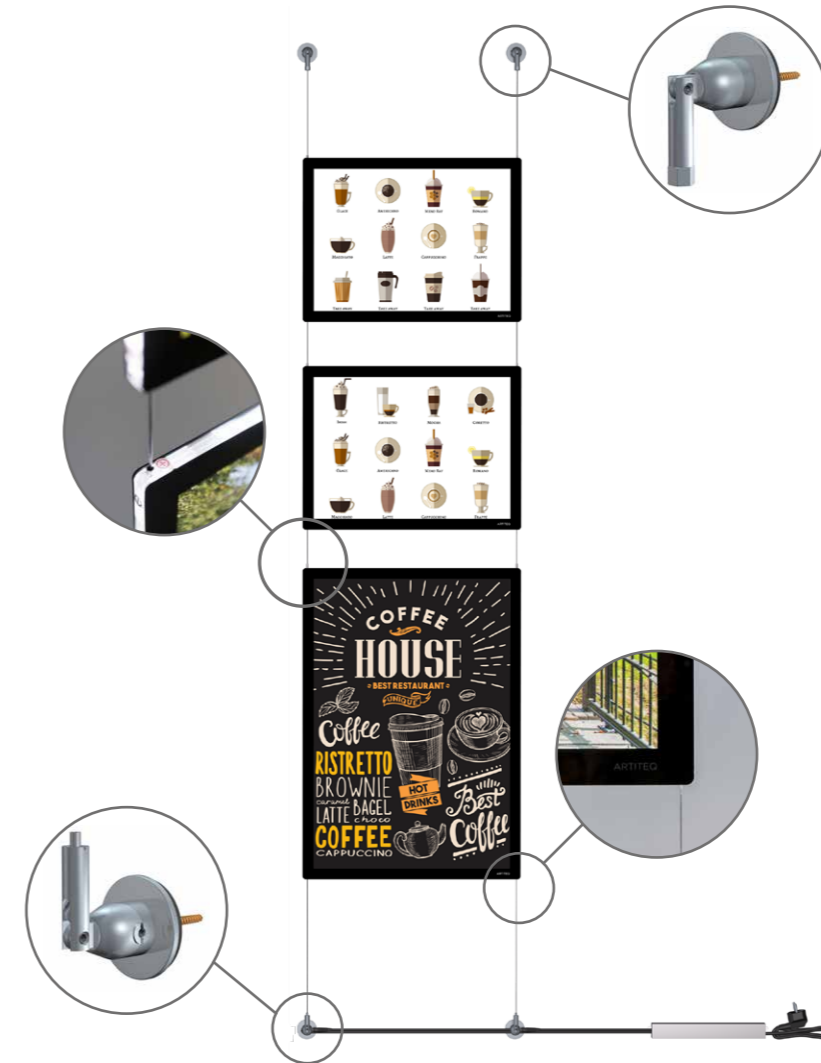

SET STEELWIRE

HANGING SET
2x 300 cm
ARTICLE NO. 7710.030

DISPLAY IT LED PANELS

The A3, A4, A2 and A1 LED panels can be used in landscape and portrait format. The 2x A4 and 3x A4 LED panels can only be used in portrait format. All LED panels are equipped with bright LED lighting. The steel cables run through an auto-grip mechanism through the LED panels, connecting these together. This gives a professional, streamlined display and allows the height of the panels to be quickly and easily adjusted. This system allows double-sided displays: translucent paper can be inserted into the front and back of the LED panels.

LED PANELS

ARTICLE NO.	7700.004	A4 (landscape & portrait)	9 watt
ARTICLE NO.	7700.003	A3 (landscape & portrait)	17 watt
ARTICLE NO.	7700.002	A2 (landscape & portrait)	22 watt
ARTICLE NO.	7700.020	2x A4 (portrait only)	17 watt
ARTICLE NO.	7700.021	3x A4 (portrait only)	24 watt

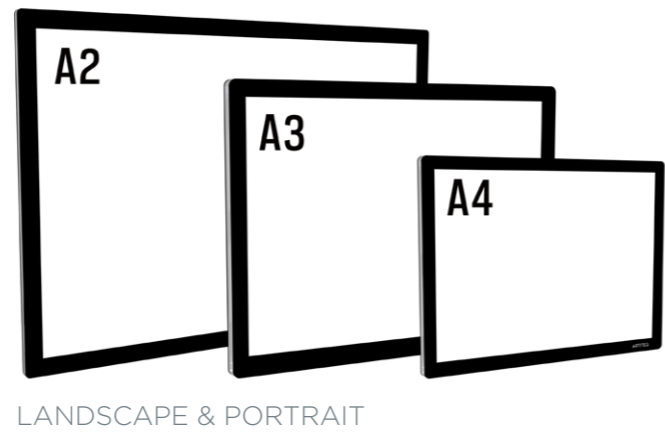
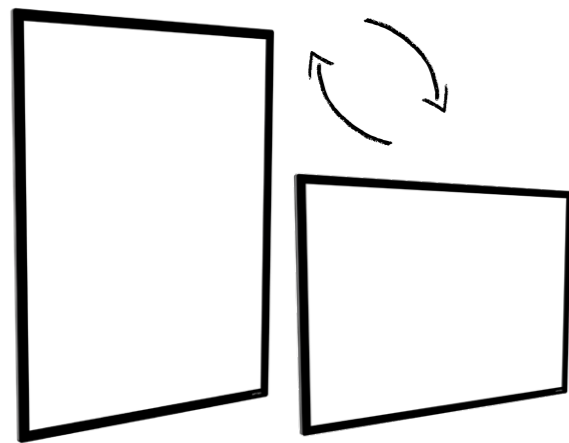
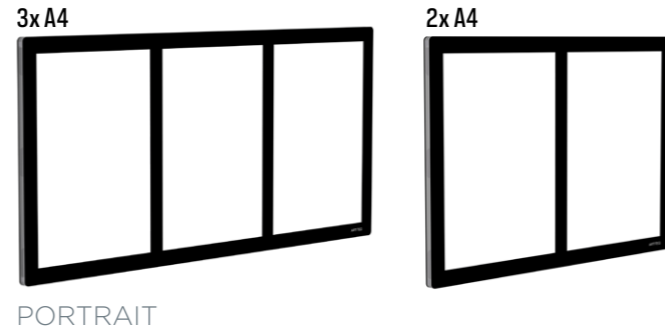

PREMIUM NEVERTEAR BACKLIT PAPER

xerox

7706.004	A4
7706.003	A3

TRANSFORMERS

TRANSFORMER*	TRANSFORMER DIMMABLE**
60 VA	200 VA
ARTICLE NO. 7730.060	ARTICLE NO. 7730.200
	ARTICLE NO. 7730.150CA

* TOTAL LENGTH OF CABLE TRANSFORMER 5m
 ** ONLY USABLE WITH APP 'CASAMBI'



DISPLAY IT LED PANELS

POSSIBLE COMBINATIONS:

COMBINATION A

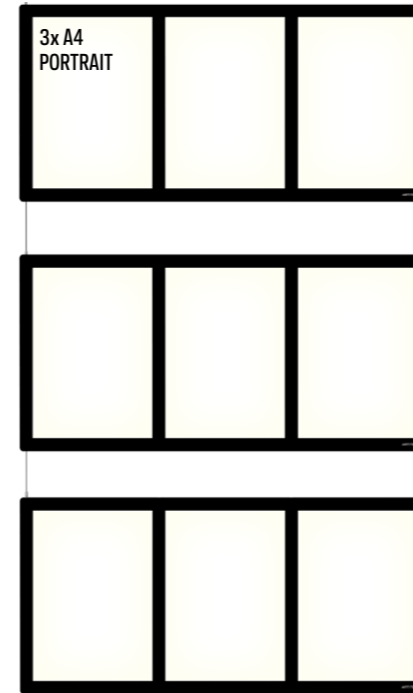

COMBINATION B

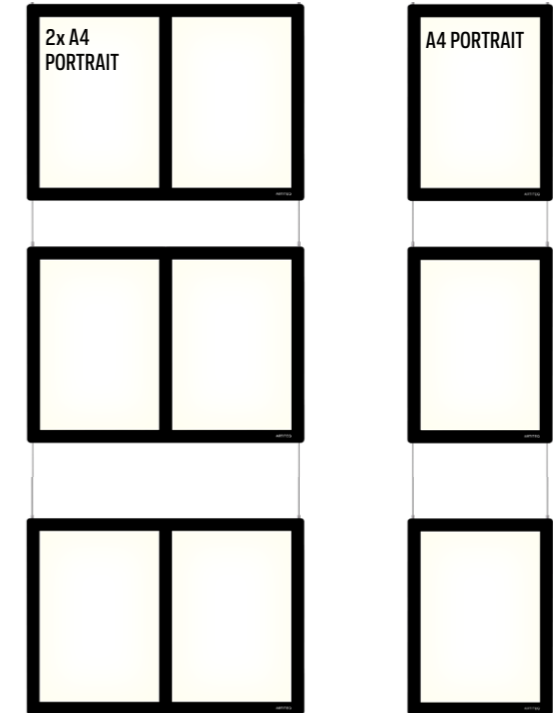

COMBINATION C

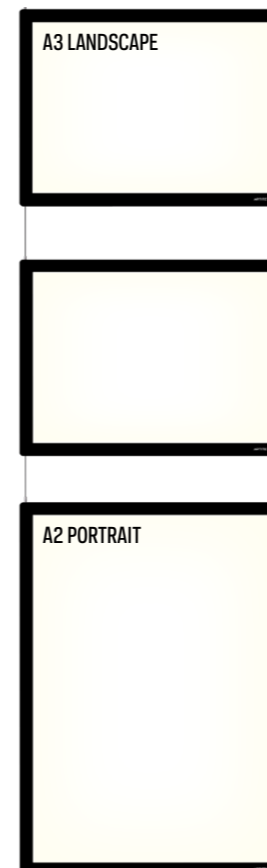

COMBINATION D



DISPLAY IT FIXED

Display It: professional and orderly

The Display It presentation system gives you a professional and orderly way to display your announcements or documents. The system's acrylic frames are easy to mount and adjust to the desired height. Thanks to the E-Clip for Display It, you can change the contents of the acrylic frames in seconds. The clip also makes it easy to connect the frames to one another, making both horizontal and vertical displays possible. This display system is ideal for estate agents and is often used as a 'face wall' for photos of staff displayed on the wall in hospitals and other institutions. Display It is available in Flex and Fixed mounting models. The Display It Flex version is used in combination with a hanging rail and stainless steel rods that are easy to reposition along the rail.



DISPLAY IT FIXED

SET STEELWIRE

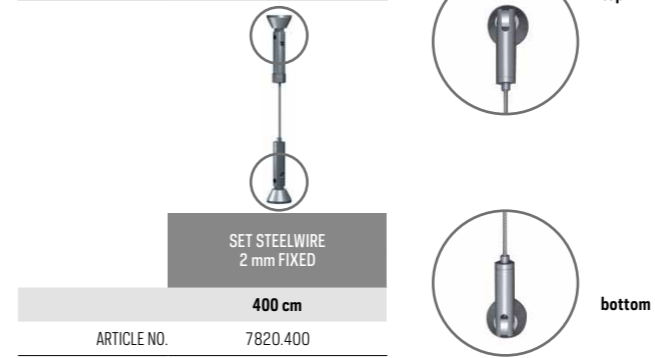

CLAMPS



DISPLAYS

ARTICLE NO.	7803.211	2 mm A4	30 x 21 cm LANDSCAPE
ARTICLE NO.	7803.212	2 mm A4	21 x 30 cm PORTRAIT
ARTICLE NO.	7803.301	2 mm A3	42 x 30 cm LANDSCAPE
ARTICLE NO.	7803.302	2 mm A3	30 x 42 cm PORTRAIT

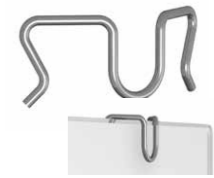

SPRING DISPLAY IT METAL
7805.006

ALL-IN SET



EASY TO CHANGE CONTENT

DISPLAY IT FLEX

Display It: professional and orderly

The Display It presentation system gives you a professional and orderly way to display your announcements or documents. The system's acrylic frames are easy to mount and adjust to the desired height. Thanks to the E-Clip for Display It, you can change the contents of the acrylic frames in seconds. The clip also makes it easy to connect the frames to one another, making both horizontal and vertical displays possible. This display system is ideal for estate agents and is often used as a 'face wall' for photos of staff displayed on the wall in hospitals and other institutions. Display It is available in Flex and Fixed mounting models. The Display It Flex version is used in combination with a hanging rail and stainless steel rods that are easy to reposition along the rail.

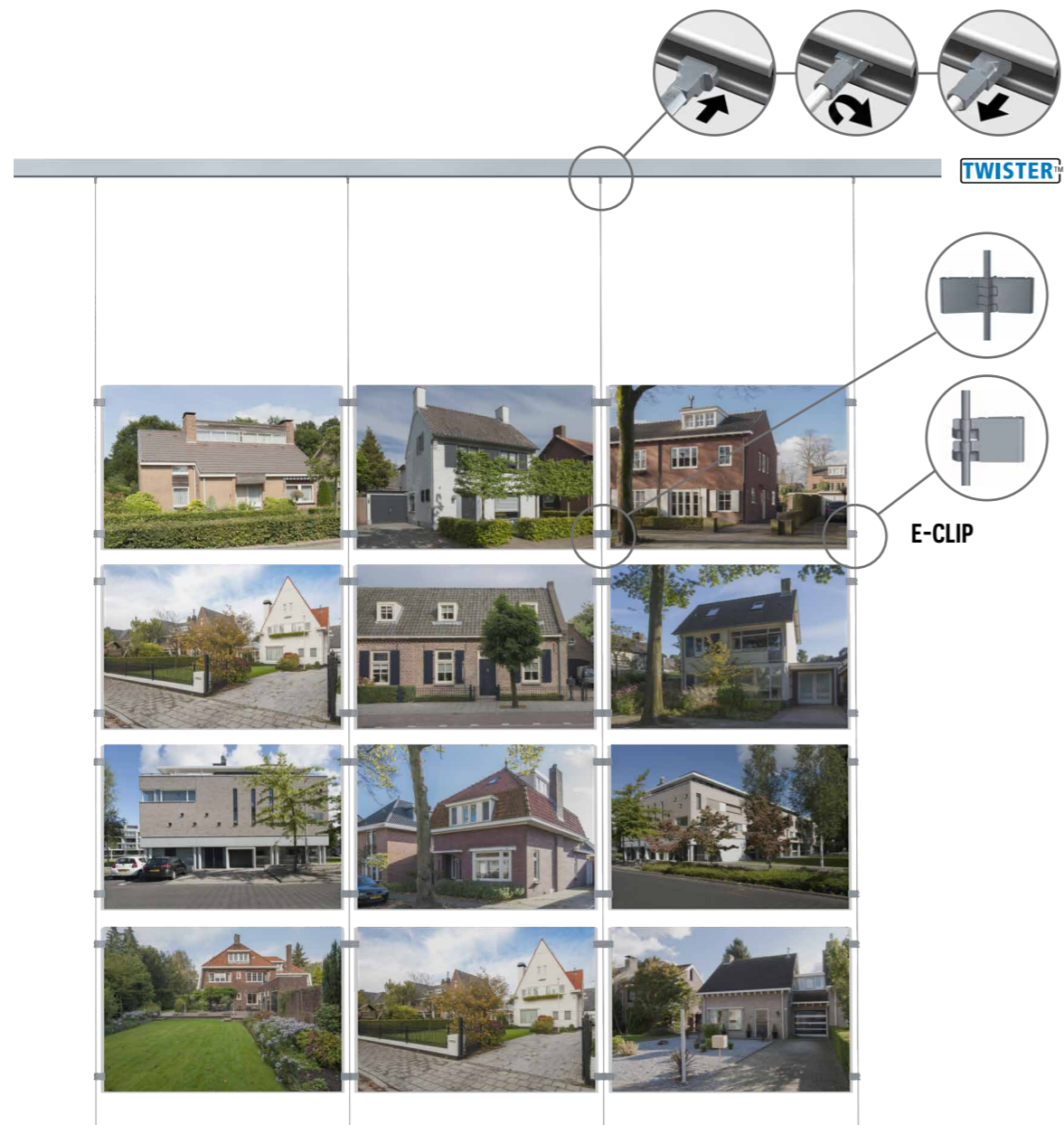

DISPLAY IT FLEX

CAN BE USED WITH ALL ARTITEQ PICTURE HANGING SYSTEMS



EASY TO CHANGE CONTENT



RODS

	TWISTER 2 mm ROD STAINLESS STEEL	TWISTER 2 mm ROD WHITE
	200 cm	200 cm
ARTICLE NO.	9.4188	9.4198

CLAMPS

E-CLIP	CLAMP SINGLE	CLAMP DOUBLE
2 mm	2-4 mm	2-4 mm
ARTICLE NO.	7805.005	7805.001 7805.002



installation video

DISPLAYS

	ARTICLE NO.	7803.211	2 mm A4	30 x 21 cm LANDSCAPE
	ARTICLE NO.	7803.212	2 mm A4	21 x 30 cm PORTRAIT
	ARTICLE NO.	7803.301	2 mm A3	42 x 30 cm LANDSCAPE
	ARTICLE NO.	7803.302	2 mm A3	30 x 42 cm PORTRAIT



SPRING DISPLAY IT METAL
7805.006

HANGING WHITEBOARDS

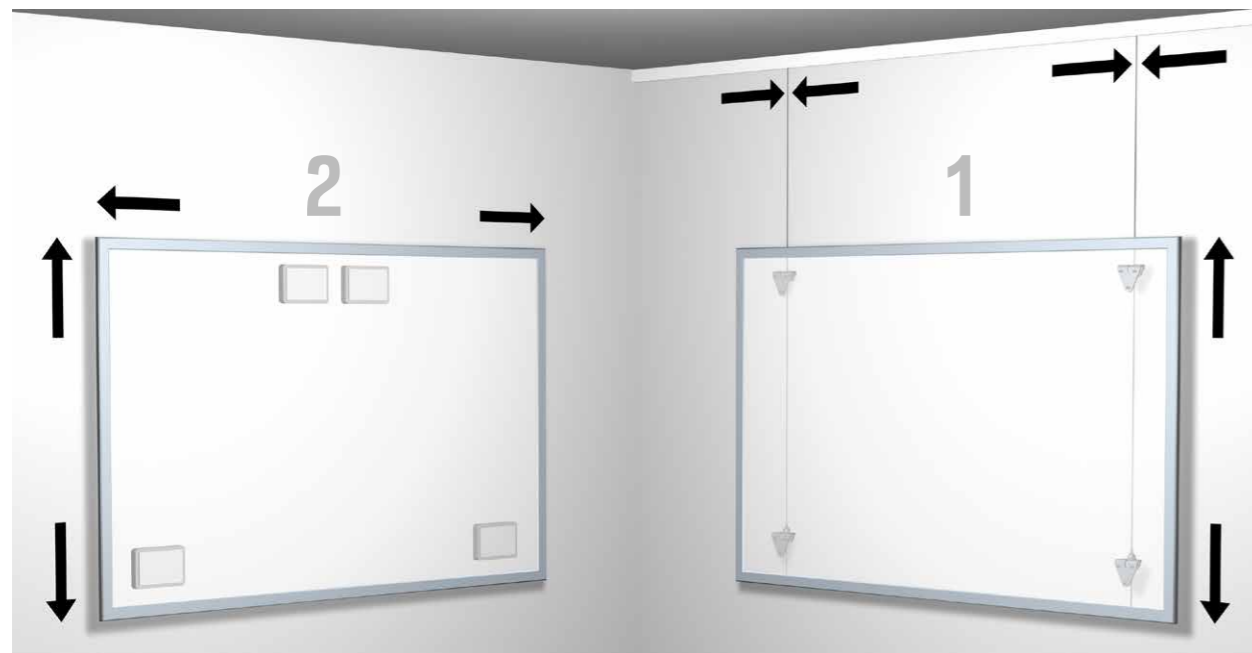

There are a variety of ways to hang a whiteboard on the wall. Hanging a whiteboard with the aid of the Whiteboardset offers the option of repositioning the whiteboard either horizontally or vertically. The Artiteq Whiteboardset has been designed to make it easy to hang a whiteboard on the wall, and offers flexibility since it may be used in combination with our hanging rails. The clamps ensure a stable mounting of the whiteboard to the wall. By combining the Whiteboardset with the hanging rail, it is extremely easy to mount the whiteboard to the precise desired spot.



WHITEBOARDSET / HANGING MAGNET FOR WHITEBOARDS



1



MAX
30
KG/M

10
YEAR
WARRANTY



WHITEBOARDSET



WHITEBOARDSET
(HANGING WIRE
NOT INCLUDED)*

CLAMP UP

CLAMP DOWN

SCREW 10 mm

ARTICLE NO. 9.4550

CAN BE USED IN COMBINATION WITH ALL ARTITEQ PICTURE HANGING SYSTEMS
* TO BE USED WITH TWISTER 2 mm STEELWIRE (SEE PAGE 64)

2

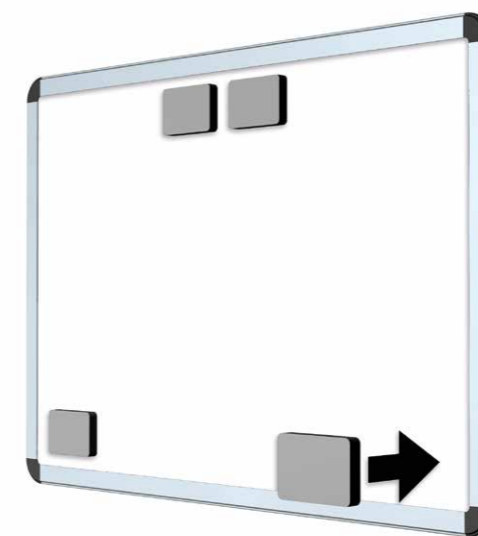

SELF-ADHESIVE HANGING MAGNET FOR WHITEBOARDS

7430.001

SELF-ADHESIVE HANGING MAGNET FOR WHITEBOARDS

75 x 50 x 11 mm



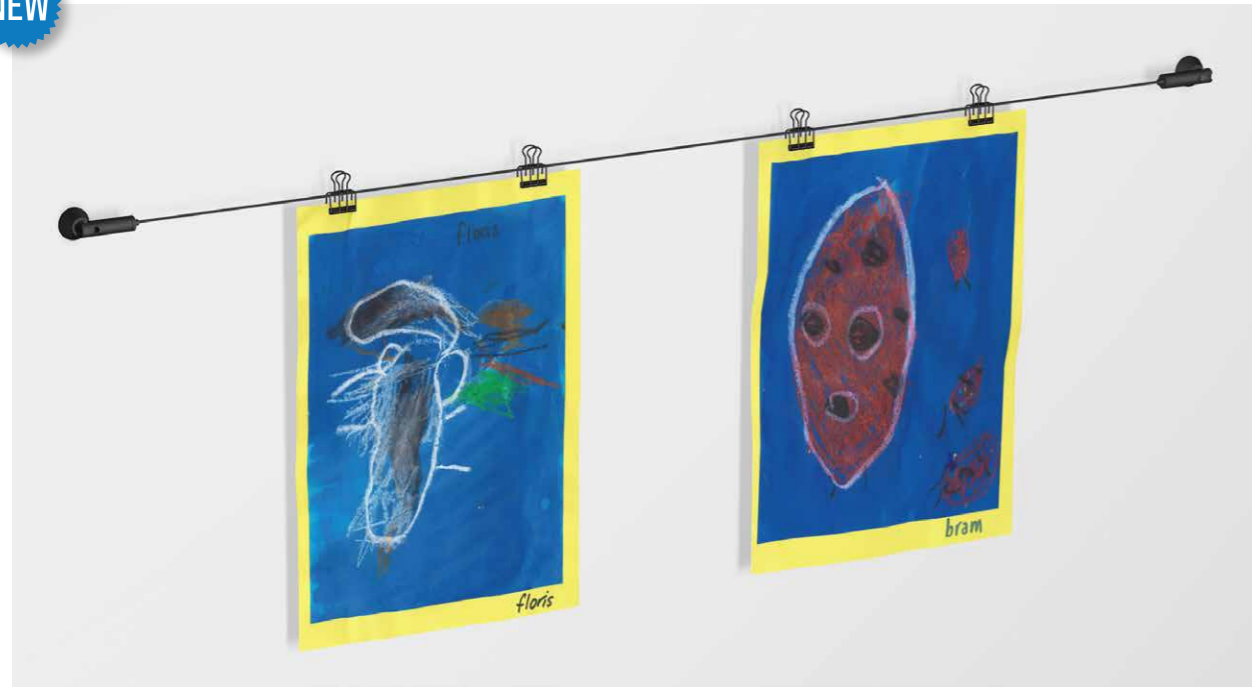

MAX. 3 kg

TENSION SET WIRE

NEW



For hanging drawings, posters, crafts, garlands or decorations horizontally, this Tension wire set is the solution. The Tension wire set consists of 300 cm long black steel wire and can be combined with black paper clips in the shape of a water drop or black paper clips. The black steel wire is magnetic - choose fun magnets to hang the drawings that way. Attach the wall mount to the wall at the desired height and tension the steel wire. Perfect for the classroom or school hallways!

	 <p>12x</p>	 <p>30x</p>	
<p>TENSION SET: STEELWIRE BLACK 300 cm + WALL MOUNTING 5 kg</p>	<p>PAPER CLIP BLACK</p>	<p>PAPER CLIP WATER DROP BLACK</p>	
<p>ARTICLE NO. 7807.570</p>	<p>808.050</p>	<p>808.040</p>	

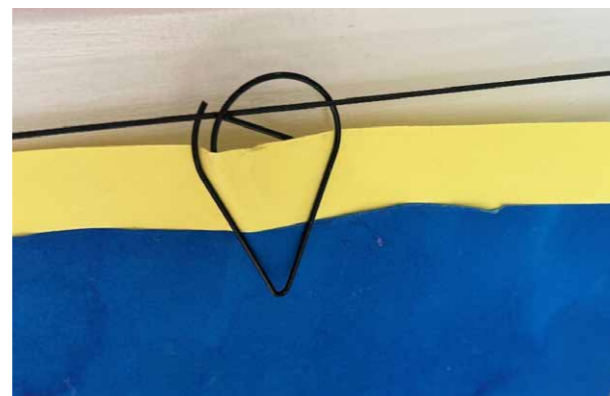

► DISPLAY HANGING SYSTEMS

RAIL SYSTEMS

- FLEXIBLE PRESENTATION OF DRAWINGS, DOCUMENTS AND INFORMATION
- DIRECT WALL MOUNTING
- SIMPLE AND QUICK CHANGE OF DRAWINGS
- EXPAND WITH ADDITIONAL ACCESSORIES







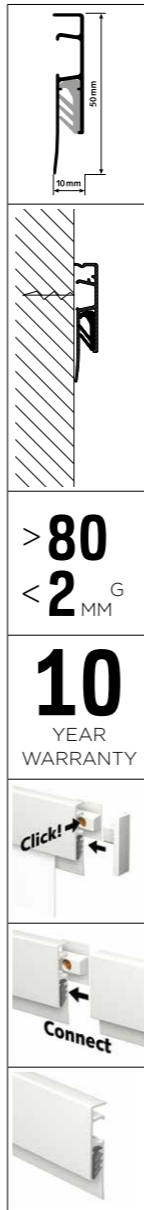









FLEXIBLE
MULTIFUNCTIONAL
EASE-OF-USE



INFO RAIL



INFO RAIL

	05.55025	INFO RAIL WHITE	25 cm	INCLUDES FASTENER MATERIAL AND END CAPS
	05.55050	INFO RAIL WHITE	50 cm	INCLUDES FASTENER MATERIAL AND END CAPS
	05.55100	INFO RAIL WHITE	100 cm	INCLUDES FASTENER MATERIAL AND END CAPS
	05.55200	INFO RAIL WHITE	200 cm	INCLUDES FASTENER MATERIAL AND END CAPS
	05.55300	INFO RAIL WHITE	300 cm	INCLUDES FASTENER MATERIAL AND END CAPS
	05.54025	INFO RAIL ALU	25 cm	INCLUDES FASTENER MATERIAL AND END CAPS
	05.54050	INFO RAIL ALU	50 cm	INCLUDES FASTENER MATERIAL AND END CAPS
	05.54100	INFO RAIL ALU	100 cm	INCLUDES FASTENER MATERIAL AND END CAPS
	05.54200	INFO RAIL ALU	200 cm	INCLUDES FASTENER MATERIAL AND END CAPS
	05.54300	INFO RAIL ALU	300 cm	INCLUDES FASTENER MATERIAL AND END CAPS
	05.56025	INFO RAIL BLACK STRUCTURE	25 cm	INCLUDES FASTENER MATERIAL AND END CAPS
	05.56100	INFO RAIL BLACK STRUCTURE	100 cm	INCLUDES FASTENER MATERIAL AND END CAPS
	05.56200	INFO RAIL BLACK STRUCTURE	200 cm	INCLUDES FASTENER MATERIAL AND END CAPS
	05.55200M	INFO RAIL MAGNETIC WHITE	200 cm	INCLUDES FASTENER MATERIAL, END CAPS AND 4 MOUSE MAGNETS
	05.47160	END CAP INFO RAIL WHITE (L&R)		
	05.47150	END CAP INFO RAIL GREY (L&R)		
	05.47170	END CAP INFO RAIL BLACK (L&R)		



installation video



Artiteq Info Rail in education

Tip!
Complete the Info Rail with 4 accessories! Look on the next page.

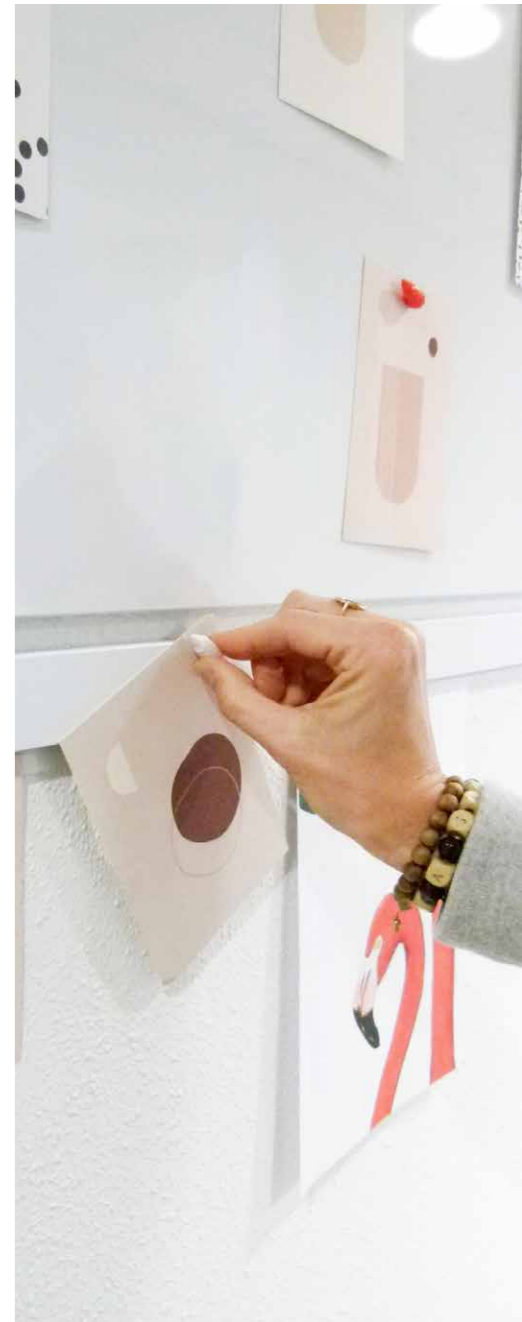

The Info Rail is the ideal display system for displaying cards, posters, drawings and photos on the wall. Thanks to the Info Rail, you can create a tidy, orderly display of your documents. This system means no more damaged walls from thumbtacks, tape and so on, and changing drawings or posters is fast and easy. This hanging system has become particularly indispensable in classrooms and school corridors. The Info Rail is also an ideal system for displaying or sharing information at home and the office.

Easy assembly thanks to clips

The Info Rail has been developed for hanging documents using a triple rubber clamping mechanism in the rail. Paper from 80 g to cardboard 2 mm thick can be firmly clamped into the rail. After mounting the Click & Connect clips to the wall, it's easy to attach the Info Rail to the clips. Available in different lengths, the Info Rail is easy to link to other Info Rails or shortened. Whether you want to display photos or drawings or keep recipes within easy reach, the Info Rail offers the solution.



Make the Info Rail versatile using the accessories **me-clip**, **Clip Hanger**, **Support Clip** and **Storage Clip**. See next page for more information.

me-CLIP AND CLIP HANGER



me-CLIP			
	05.47100	me-CLIP BLACK	44,5(h) x 74(b) x 13(d) mm
	05.47110	me-CLIP WHITE	44,5(h) x 74(b) x 13(d) mm

 installation video

CLIP HANGER 1 KG			
	05.47200	CLIP HANGER BLACK	59(h) x 8,5(b) x 23(d) mm
	05.47210	CLIP HANGER WHITE	59(h) x 8,5(b) x 23(d) mm

 installation video

me-clip – personal and organised

The *me*-clip adds an extra personal and beautifully designed element to the Info Rail system. A name can be added to the contents of the clip. A great solution for the perfect presentation and communication tool. The clip is always adaptable and always keeps its 100% quality appearance, no matter how often the clip is used. It's handy, and directly and rapidly adaptable thanks to Info Rail's smart, flexible properties.

Clip Hanger

With a simple click, the Clip Hanger is attached to the Info Rail, allowing a craft project to be hung up. In combination with the *me*-clip, art creations can be presented in a fun and personal manner.



INFO RAIL *me*



INFO RAIL *me* ALL-IN SET

	05.53100	INFO RAIL ME WHITE	100 cm	includes 4 x <i>me</i> -clip	INCLUDES FASTENER MATERIAL AND END CAPS
	05.53200	INFO RAIL ME WHITE	200 cm	includes 4 x <i>me</i> -clip	INCLUDES FASTENER MATERIAL AND END CAPS

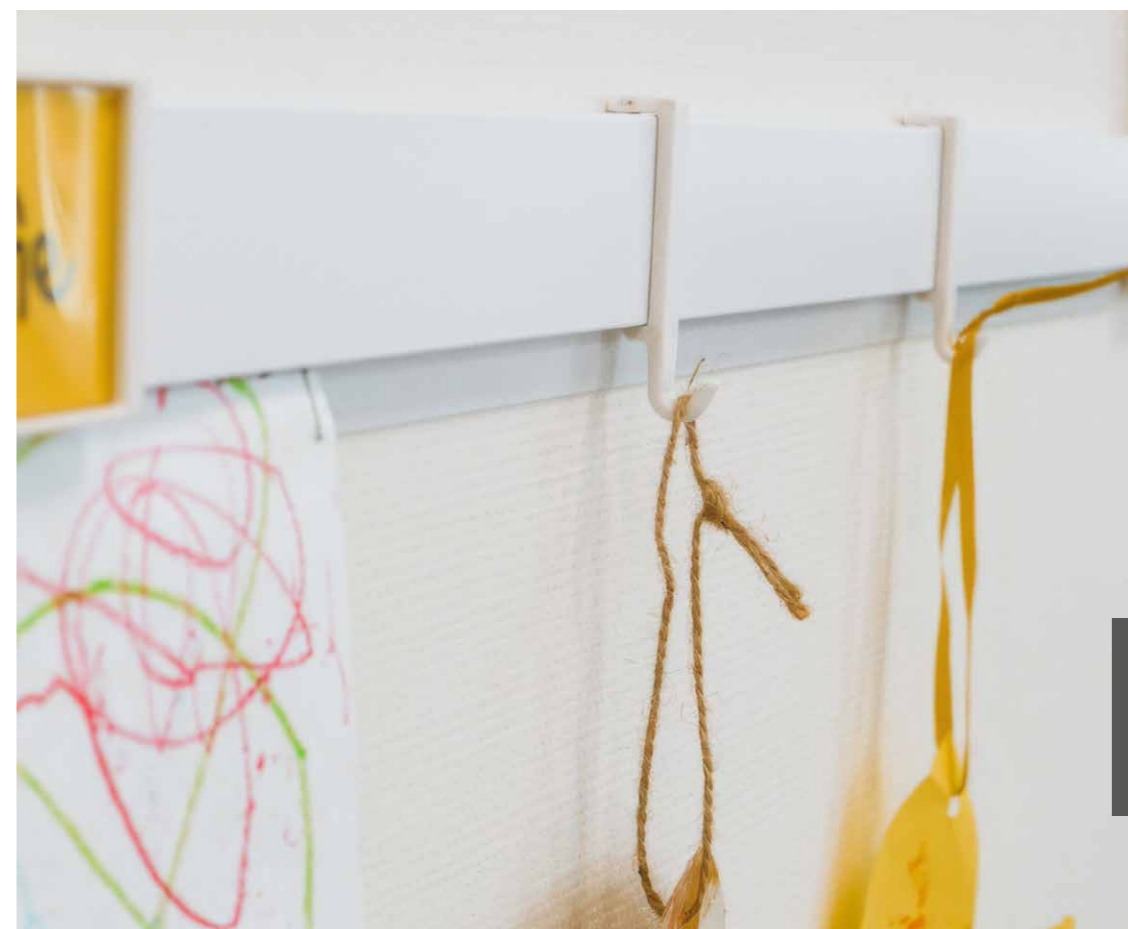

FLEXIBLE
MULTIFUNCTIONAL
EASE-OF-USE

STORAGE CLIP AND SUPPORT CLIP

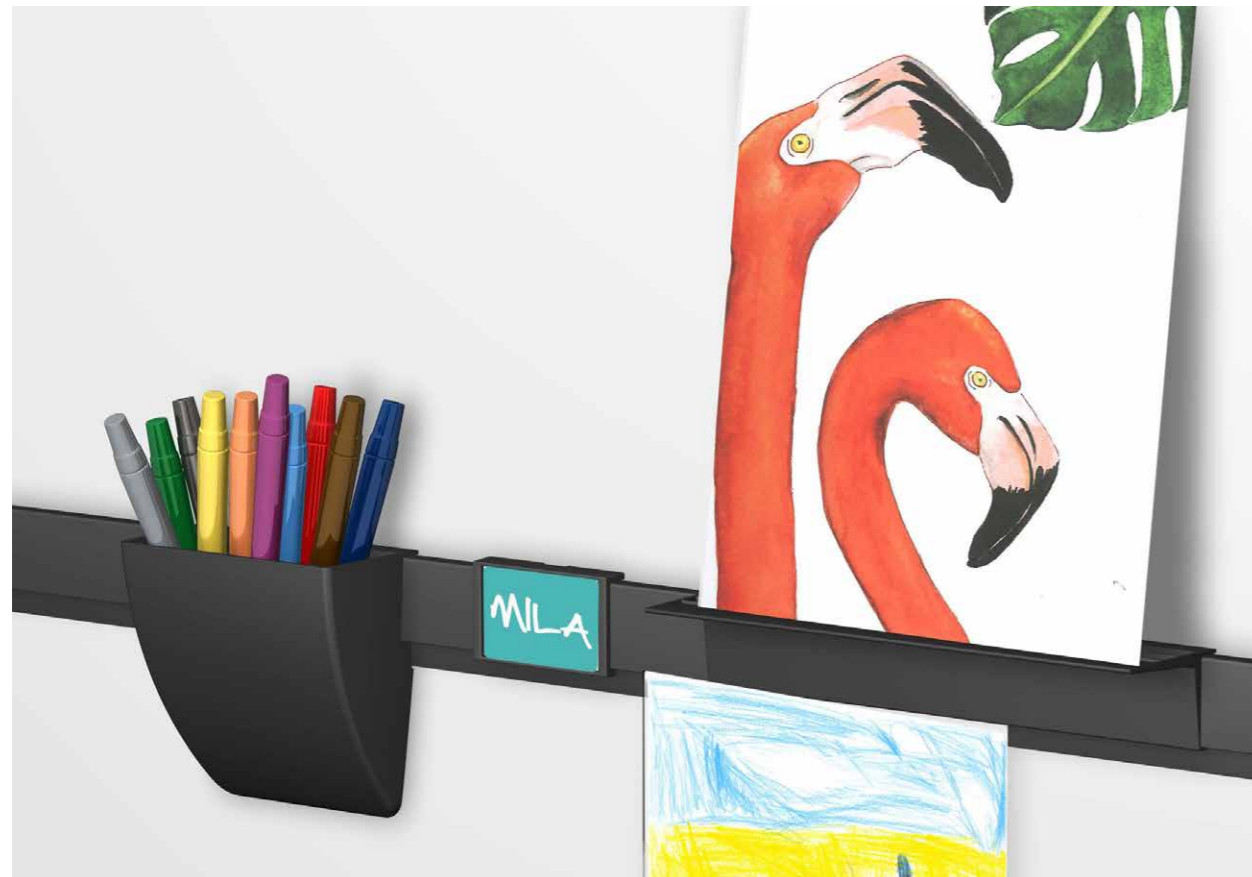

Two useful additional accessories

The Support Clip and Storage Clip are two useful additional accessories for on the Info Rail and Info Rail Magnetic.

Both accessories add an extra dimension and element to the Info Rail concept. With the Support Clip, you can easily present small crafts, greeting cards, small frames or paintings on canvas. The Support Clip is simply attached to the rail at any desired location. On the 6cm wide and 25cm long surface, changing small crafts, greeting cards or small frames is easy and quick.

The subtle grooves ensure that the presented products remain securely in place. The Storage Clip is a practical additional storage compartment for pens, markers or other small items. Just like the Support Clip, the Storage Clip is simply attached to the rail at any desired location. The stylish round shape has a timeless appeal. Both accessories are available in black and white.

STORAGE CLIP



05.47400	STORAGE CLIP BLACK 1 kg	60 (h) x 126 (b) x 123 (d) mm
05.47410	STORAGE CLIP WHITE 1 kg	60 (h) x 126 (b) x 123 (d) mm



SUPPORT CLIP



05.47300	SUPPORT CLIP BLACK 1 kg	60 (h) x 250 (b) x 42 (d) mm
05.47310	SUPPORT CLIP WHITE 1 kg	60 (h) x 250 (b) x 42 (d) mm



INFO RAIL+

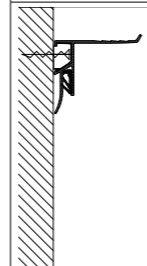
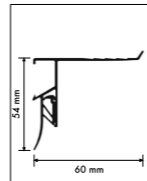

> 80
< 2^G
MM

max.
5
KG/M

10
YEAR
WARRANTY

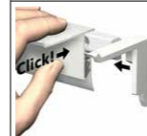

installation
video

Versatile presentation system on the wall

With Info Rail + you can create a versatile presentation system on the wall. Photos, drawings or recipes are easily clamped into the rail, as you may already be used to from our Info Rail. On top is a 6 cm wide area where small photo frames, canvas paintings, greeting cards or other small crafts can be presented. An ideal, flexible and versatile presentation system where walls do not need to be damaged and the changing of drawings, posters or frames is quick and easy. Paper from 80 g up to cardboard with a thickness of 2 mm are firmly clamped in the rail thanks to a double plastic clamping mechanism. The top surface of 6 cm has some subtle grooves to present a card or a list stably.

INFO RAIL +

05.57200

INFO RAIL + WHITE

200 cm

INCLUDES FASTENER MATERIAL AND END CAPS



05.47180

END CAP INFO RAIL + WHITE (L&R)



Stappenplan spelling:

1. Luister naar het woord
2. Verdeel in klankgroepen pe - ten
3. Welke spellingsproblemen komen er in voor?
4. Schrijf het woord nu op
5. Controleer

CARD RAIL



CARD RAIL

1x



CARD RAIL WHITE (RAL 9016)
FASTENER MATERIAL
AND END CAPS INCLUDED

4x



MOUSE MAGNETS
WHITE

ARTICLE NO. 7220.110

EXTRA / OPTIONAL



7430.010 MOUSE MAGNETS COLOUR

7430.020 MOUSE MAGNETS WHITE

Practical use of narrow wall spaces

This vertical display system takes up little space and can therefore be used in many places in an office or home. The Card Rail is a hanging system for, for example, cards and photos and this is a useful system for collecting or displaying these. The cards and photos can be slid into both sides of the rail. The Card Rail also has a magnetic strip, which can also be used to display photos, cards, etc. The Mouse Magnets can be used on the front of the Card Rail. This display system can be a practical addition to the wall in especially an office, kitchen or child's bedroom.

The Card Rail has a sleek, white finish, RAL 9016 (can be repainted) and is 114 cm in length. Ideal for use in narrow wall spaces in different areas of the home or office.

▶ DISPLAY HANGING SYSTEMS

MISCELLANEOUS



FLEXIBLE
HIGH QUALITY
MULTIFUNCTIONAL

CLICK FRAMES AND POSTER SYSTEMS



CLICK FRAMES



7020.021 **CLICK FRAME 20 mm A4 21 x 30 cm**

7025.030 **CLICK FRAME 25 mm A3 30 x 42 cm**

7025.042 **CLICK FRAME 25 mm A2 42x 60 cm**

POSTER SYSTEMS

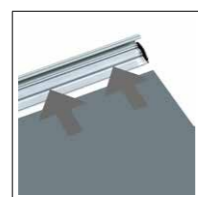

7350.050 **POSTER SNAP 50 cm**

7350.070 **POSTER SNAP 70 cm**

7350.100 **POSTER SNAP 100 cm**

7350.120 **POSTER SNAP 120 cm**



► SIGN HANGING SYSTEMS

- SIGNAGE INSIDE BUILDING
- HANGING ACOUSTIC PANELS FROM THE CEILING
- POSSIBILITIES FOR CEILINGS AND RECESSED CEILINGS
- VARIOUS COMBINATIONS POSSIBLE

PROFESSIONAL
SAFE
FLEXIBLE



XPO RAIL LOW HANGING

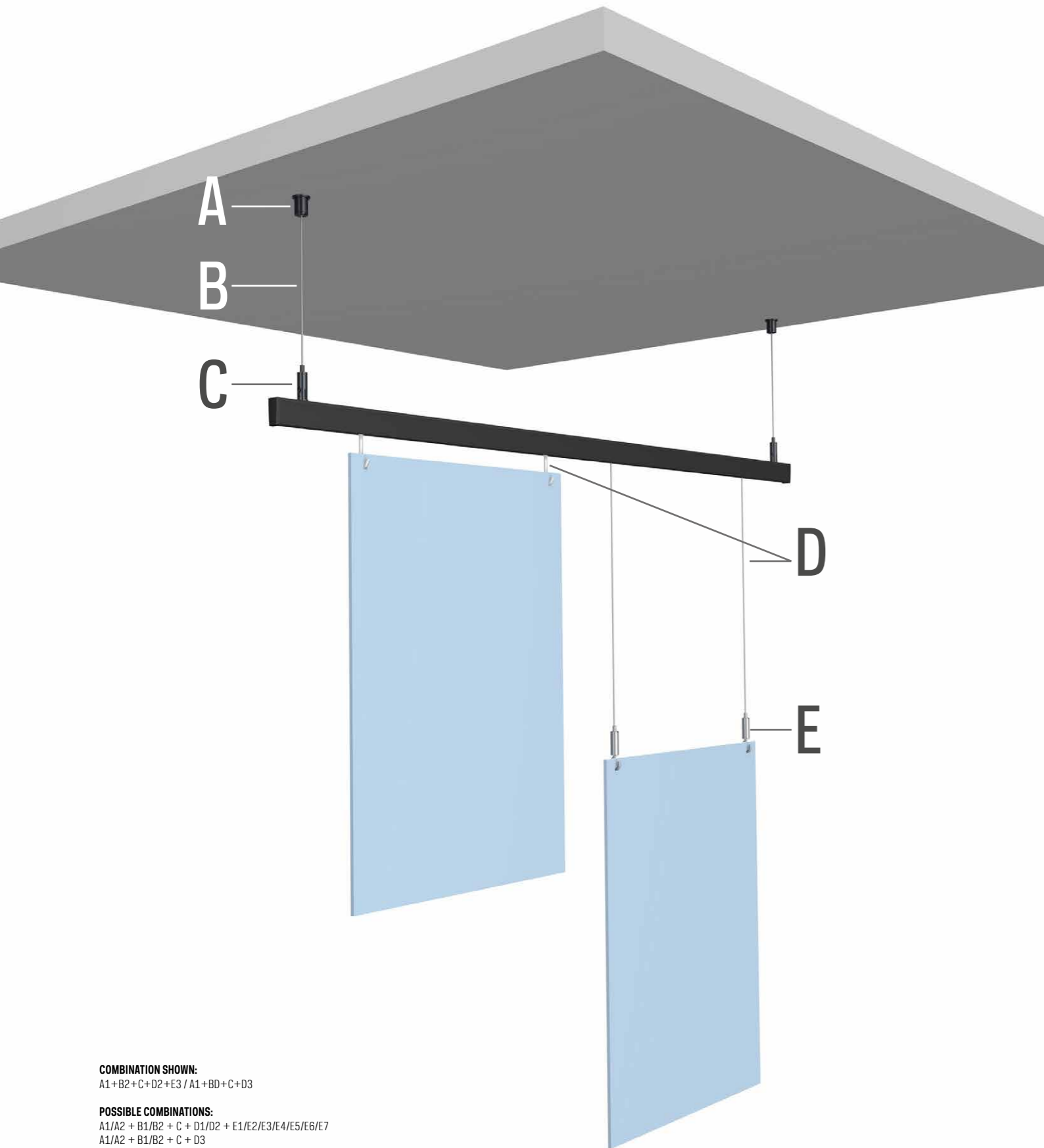

COMBINATION SHOWN:
A1+B2+C+D2+E3 / A1+BD+C+D3

POSSIBLE COMBINATIONS:
A1/A2 + B1/B2 + C + D1/D2 + E1/E2/E3/E4/E5/E6/E7
A1/A2 + B1/B2 + C + D3
A3 + B3/B4 + C + D1/D2 + E1/E2/E3/E4/E5/E6/E7
A3 + B3/B4 + C + D3

XPO RAIL LOW HANGING

A	A1			A2			A3
CEILING BRACKET BLACK C01BL	FISCHER DUOPOWER 5X25 5 mm	SCREW	CEILING BRACKET NICKEL C01NI	FISCHER DUOPOWER 5X25 5 mm	SCREW	CEILING SUSPENSION AUTO GRIP 1,2 mm CS01NI	
7807.100	9.4934	9.4945	7807.110	9.4934	9.4945	7807.140	

B	B1	B2	B3	B4
STEELWIRE + SLIDER 1,2 mm 300 cm BLACK	STEELWIRE + SLIDER 1,2 mm 300 cm NICKEL	STEELWIRE 7 x 7 1,2 mm 10 m*	STEELWIRE BLACK 7 x 7 1,2 mm 3 m*	
7807.200	7807.210	7807.350	7807.360	

C	C		
SUSPENSION BRACKET XPO RAIL 1,2 mm	XPO RAIL 200 cm BLACK	END CAP XPO RAIL BLACK	
7807.060	05.15201	05.15030	

D	D1	D2	D3
STEELWIRE + SLIDER 1,2 mm 300 cm BLACK	STEELWIRE + SLIDER 1,2 mm 300 cm NICKEL	TWISTER HOOK	
7807.200	7807.210	9.4510	

E	E1	E2	E3	E4	E5	E6	E7
STEELWIRE HOOK AUTO GRIP 1,2 mm ST01BL	STEELWIRE HOOK AUTO GRIP 1,2 mm ST01NI	STEELWIRE HOOK AUTO GRIP 1,2 mm ST02NI	STEELWIRE HOOK AUTO GRIP 1,2 mm ST03NI	STEELWIRE CLAMPHOOK AUTO GRIP 1,2 mm STC01NI	STEELWIRE HOOK AUTO GRIP 1,2mm STD01NI NICKEL	STEELWIRE HOOK AUTO GRIP 1,2mm STD01BL BLACK	
7807.010	7807.020	7807.030	7807.040	7807.050	7807.080	7807.070	

* CABLE CUTTER 7807.900 AVAILABLE FOR USE WITH STEELWIRE 7 x 7 1,2mm

XPO RAIL

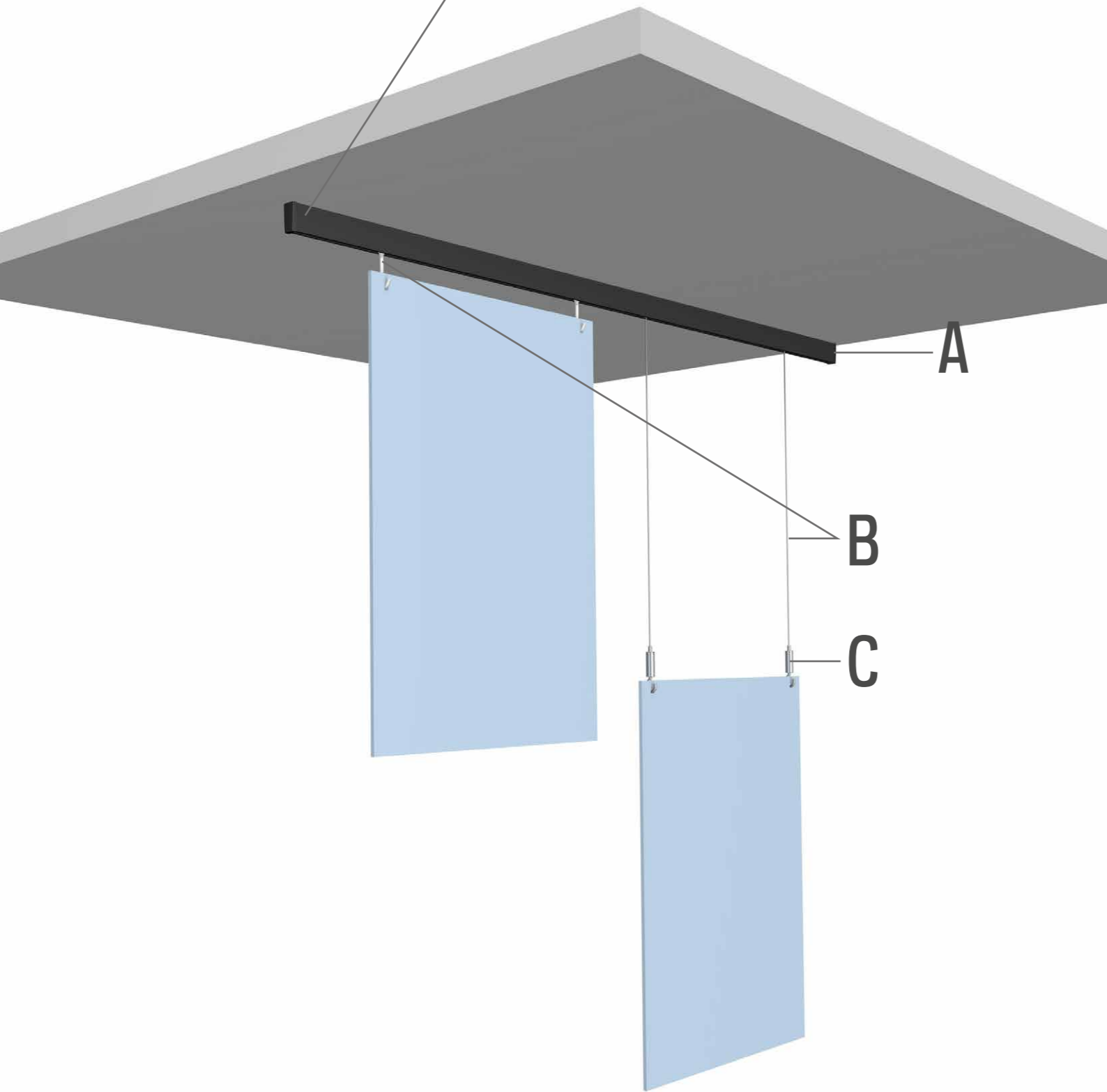
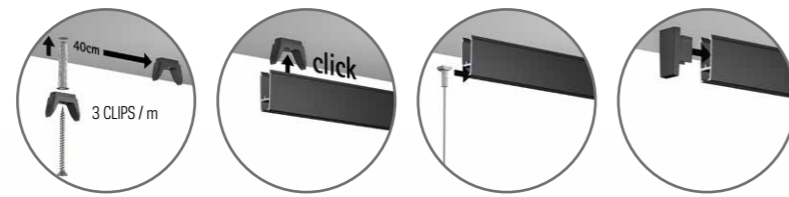

COMBINATION SHOWN:
A + B3
A + B2 + C3

POSSIBLE COMBINATIONS:
A + B1/B2 + C1/C2/C3/C4/C5/C6/C7
A + B3

XPO RAIL

A	
XPO RAIL 200 cm BLACK	XPO RAIL 200 cm WHITE PRIMER
05.15201	05.15200

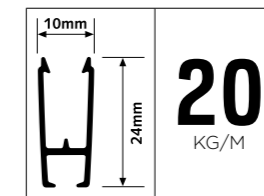

A						
END CAP XPO RAIL BLACK	END CAP XPO RAIL WHITE	CLIP CLICK&CONNECT XPO RAIL	FISCHER DUOPOWER 5X25 5 mm	SCREW 3,5 X 40 mm	FASTENER KIT XPO RAIL WHITE 200 CM	FASTENER KIT XPO RAIL BLACK/ALU 200 CM
05.15030	05.15020	05.15010	9.4934	9.4945	5092	5093

B	B1	B2	B3
STEELWIRE + SLIDER 1,2 mm 300 cm BLACK	STEELWIRE + SLIDER 1,2 mm 300 cm NICKEL	STEELWIRE HOOK	
7807.200	7807.210	9.4510	

C	C1	C2	C3	C4	C5	C6	C7
STEELWIRE HOOK AUTO GRIP 1,2 mm ST01BL	STEELWIRE HOOK AUTO GRIP 1,2 mm ST01NI	STEELWIRE HOOK AUTO GRIP 1,2 mm ST02NI	STEELWIRE HOOK AUTO GRIP 1,2 mm ST03NI	STEELWIRE CLAMPHOOK AUTO GRIP 1,2 mm STC01NI	STEELWIRE HOOK AUTO GRIP 1,2mm STD01NI NICKEL	STEELWIRE HOOK AUTO GRIP 1,2mm STD01BL BLACK	
7807.010	7807.020	7807.030	7807.040	7807.050	7807.080	7807.070	

* CONTENT FASTENER KIT

		AANTAL 200 cm
	05.15010	CLIP XPO RAIL 6x
	9.4934	PLUG FISCHER 5 mm 6x
	9.4945	SCREW FOR PLUG FISCHER 5 mm 6x
	05.15020 / 05.15030	END CAP XPO RAIL WHITE / BLACK 2x
	2639	INSTRUCTION 1x



installation video

CEILING

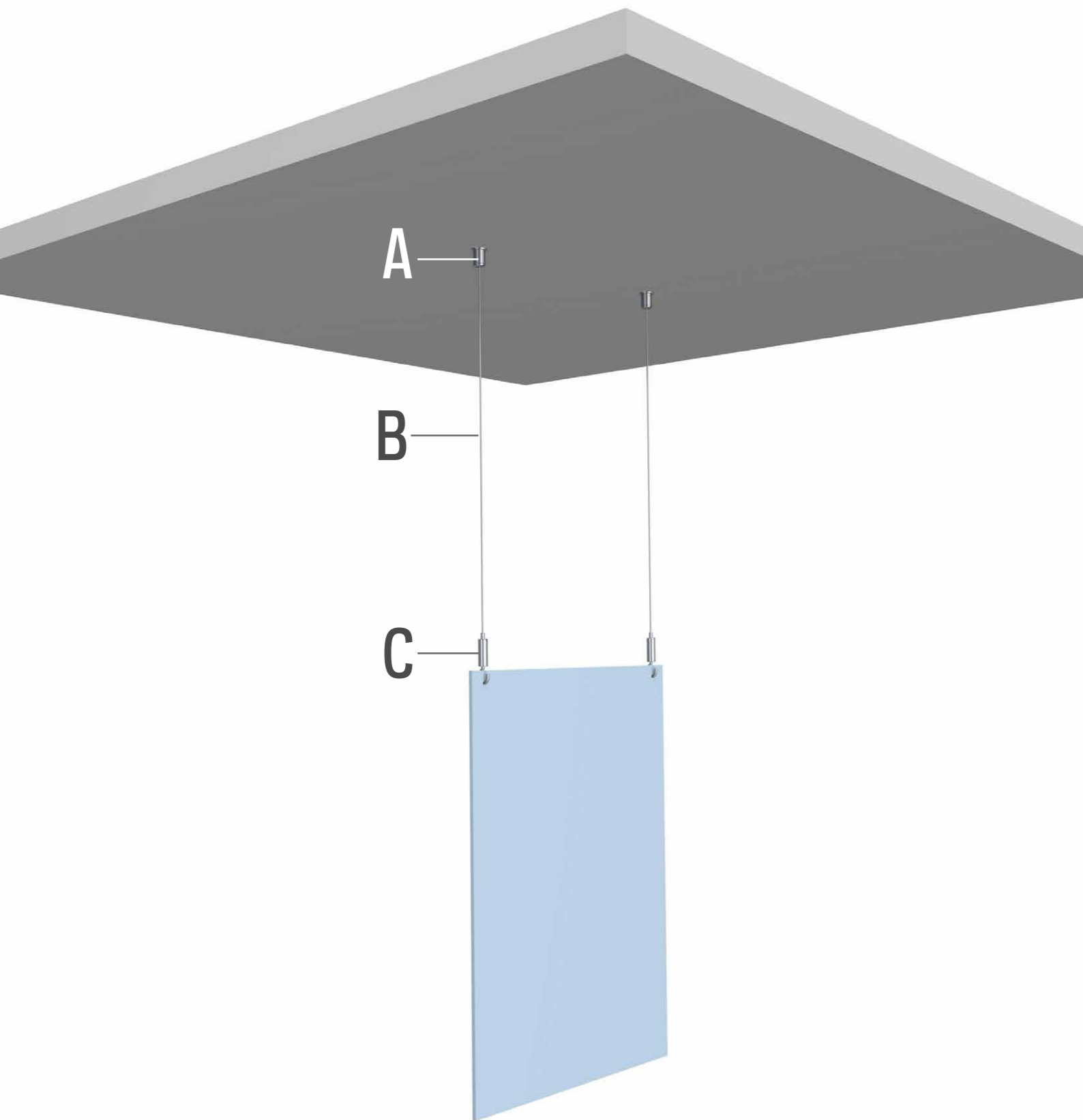

COMBINATION SHOWN:
A2 + B2 + C3

POSSIBLE COMBINATIONS:
A1/A2 + B1/B2 + C1/C2/C3/C4/C5/C6/C7
A3 + B3/B4 + C1/C2/C3/C4/C5/C6/C7

CEILING

A			A2			A3
CEILING BRACKET BLACK CO1BL	FISCHER DUOPOWER 5X25 5 mm	SCREW 3,5 X 40 mm	CEILING BRACKET NICKEL CO1NI	FISCHER DUOPOWER 5X25 5 mm	SCREW 3,5 X 40 mm	CEILING SUSPENSION AUTO GRIP 1,2 mm CS01NI
7807.100	9.4934	9.4945	7807.110	9.4934	9.4945	7807.140

B		B3		B4	
STEELWIRE + SLIDER 1,2 mm 300 cm BLACK	STEELWIRE + SLIDER 1,2 mm 300 cm NICKEL	STEELWIRE 7 x 7 1,2 mm 10 m*	STEELWIRE BLACK 7 x 7 1,2 mm 3 m*		
7807.200	7807.210	7807.350	7807.360		

C						
C1	C2	C3	C4	C5	C6	C7
STEELWIRE HOOK AUTO GRIP 1,2 mm ST01BL	STEELWIRE HOOK AUTO GRIP 1,2 mm ST01NI	STEELWIRE HOOK AUTO GRIP 1,2 mm ST02NI	STEELWIRE HOOK AUTO GRIP 1,2 mm ST03NI	STEELWIRE CLAMPHOOK AUTO GRIP 1,2 mm STC01NI	STEELWIRE HOOK AUTO GRIP 1,2mm STD01NI NICKEL	STEELWIRE HOOK AUTO GRIP 1,2mm STD01BL BLACK
7807.010	7807.020	7807.030	7807.040	7807.050	7807.080	7807.070

D	
COMPLETE SET	
2X	
SET CEILING 2x STEELWIRE 1,2 mm 300 cm + 2x CEILING BRACKET NICKEL + 2x STEELWIRE HOOK	
7807.520	

* CABLE CUTTER 7807.900 AVAILABLE FOR USE WITH STEELWIRE 7 x 7 1,2mm

CEILING SLANTED WALLS

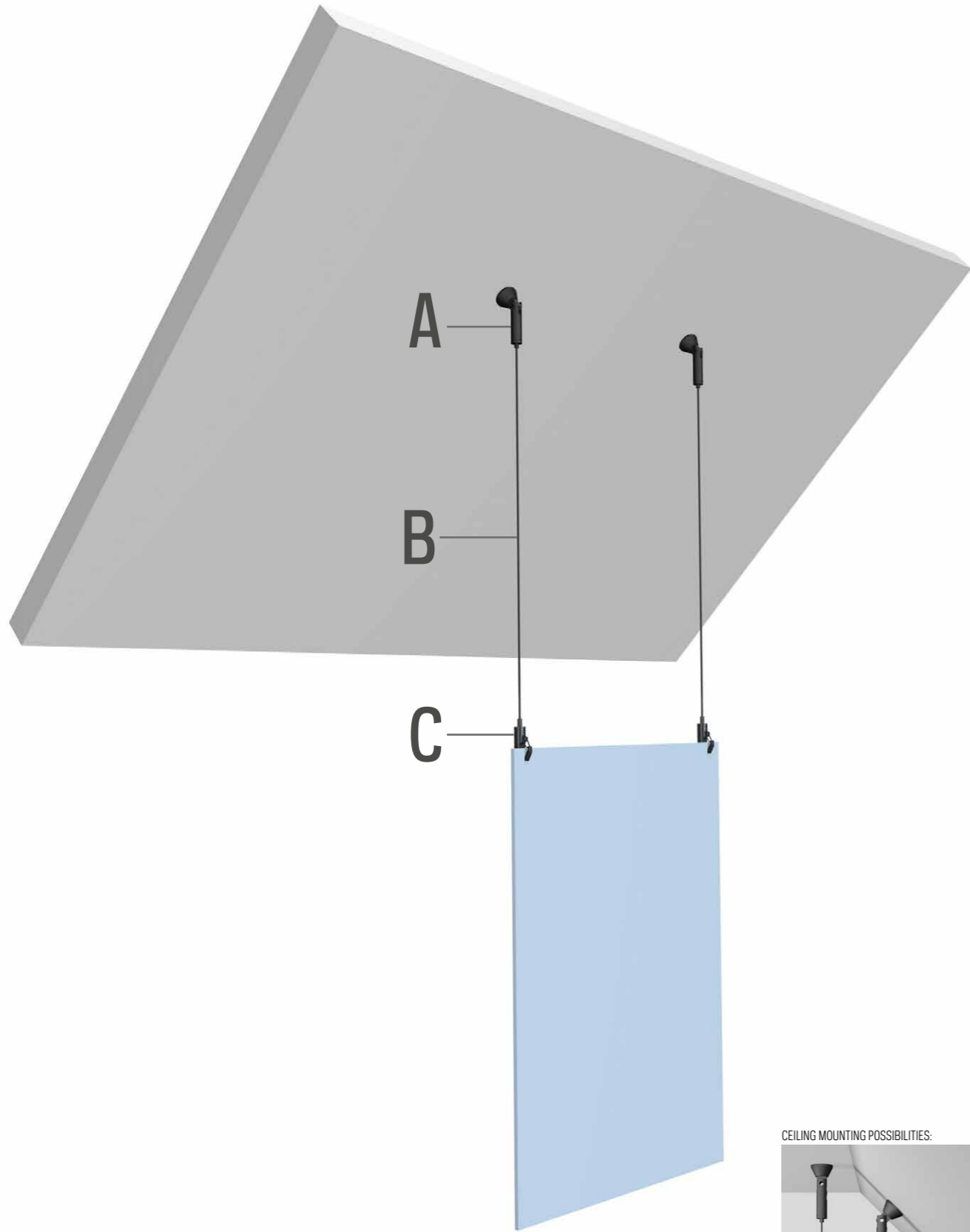

COMBINATION SHOWN:
A2 + B2 + C1

POSSIBLE COMBINATIONS:
A1/A2 + B1/B2 + C1/C2/C3/C4/C5/C6/C7

CEILING MOUNTING POSSIBILITIES:



CEILING SLANTED WALLS

A	A1		A2												
		CEILING BRACKET AUTO GRIP D01NI SILVER		CEILING BRACKET AUTO GRIP D01BL BLACK											
		7807.160		7807.150											
B	B1		B2												
		STEELWIRE 7 x 7 1,2 mm 10 m*		STEELWIRE BLACK 7 x 7 1,2 mm 3 m*											
		7807.350		7807.360											
C	C1	C2	C3	C4	C5	C6	C7								
		STEELWIRE HOOK AUTO GRIP 1,2 mm ST01BL		STEELWIRE HOOK AUTO GRIP 1,2 mm ST01NI		STEELWIRE HOOK AUTO GRIP 1,2 mm ST02NI		STEELWIRE HOOK AUTO GRIP 1,2 mm ST03NI		STEELWIRE CLAMPHOOK AUTO GRIP 1,2 mm STC01NI		STEELWIRE HOOK AUTO GRIP 1,2mm STD01NI NICKEL		STEELWIRE HOOK AUTO GRIP 1,2mm STD01BL BLACK	
		7807.010		7807.020		7807.030		7807.040		7807.050		7807.080		7807.070	

* CABLE CUTTER 7807.900 AVAILABLE FOR USE WITH STEELWIRE 7 x 7 1,2mm



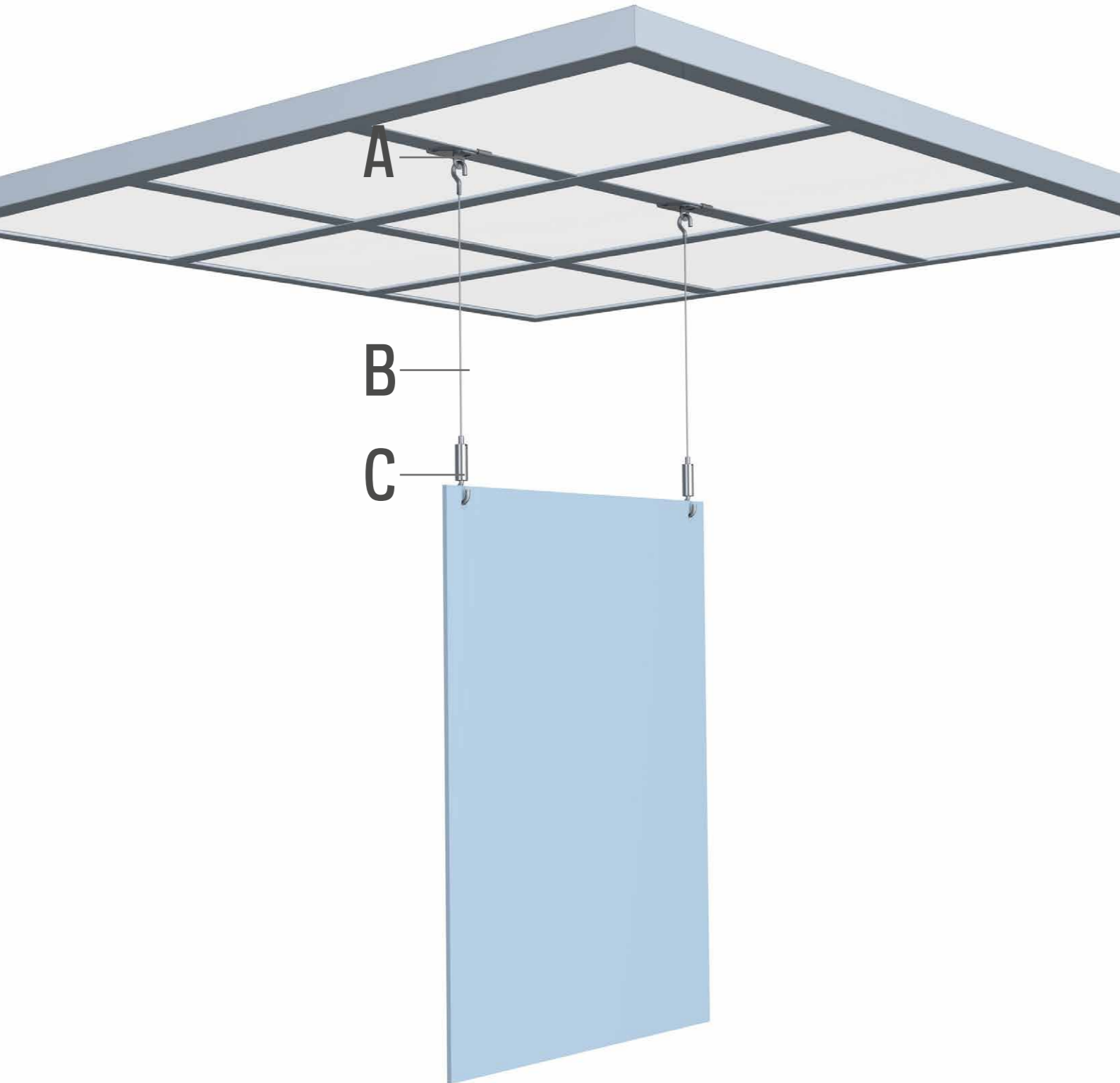











RECESSED CEILING



COMBINATION SHOWN:
A1 + B1 + C3

POSSIBLE COMBINATIONS:
A1 + B1 + C1/C2/C3/C4/C5/C6/C7
A2 + B2/B3 + C1/C2/C3/C4/C5/C6/C7

RECESSED CEILING

A	A1	A2	A3 NEW				
							
	RECESSED CEILING CLIP 24 mm 7807.120	RECESSED CEILING CLIP 24 mm + SUSPENSION AUTO GRIP 1,2 mm 7807.130	RECESSED CEILING CLIP BLACK 24 mm 7807.121				
B	B1	B2	B3				
							
	STEELWIRE + HOOK 1,2 mm 300 cm 7807.310	STEELWIRE 7 x 7 1,2 mm 10 m* 7807.350	STEELWIRE BLACK 7 x 7 1,2 mm 3 m* 7807.360				
C	C1	C2	C3	C4	C5	C6	C7
							
	STEELWIRE HOOK AUTO GRIP 1,2 mm ST01BL 7807.010	STEELWIRE HOOK AUTO GRIP 1,2 mm ST01NI 7807.020	STEELWIRE HOOK AUTO GRIP 1,2 mm ST02NI 7807.030	STEELWIRE HOOK AUTO GRIP 1,2 mm ST03NI 7807.040	STEELWIRE CLAMPHOOK AUTO GRIP 1,2 mm STC01NI 7807.050	STEELWIRE HOOK AUTO GRIP 1,2mm STD01NI NICKEL 7807.080	STEELWIRE HOOK AUTO GRIP 1,2mm STD01BL BLACK 7807.070
D	COMPLETE SET						
							
	SET RECESSED CEILING 2x STEELWIRE 1,2 mm 300 cm + 2x RECESSED CEILING CLIP + 2x STEELWIRE HOOK 7807.510						

* CABLE CUTTER 7807.900 AVAILABLE FOR USE WITH STEELWIRE 7 x 7 1,2mm

RECESSED CEILING CLIP

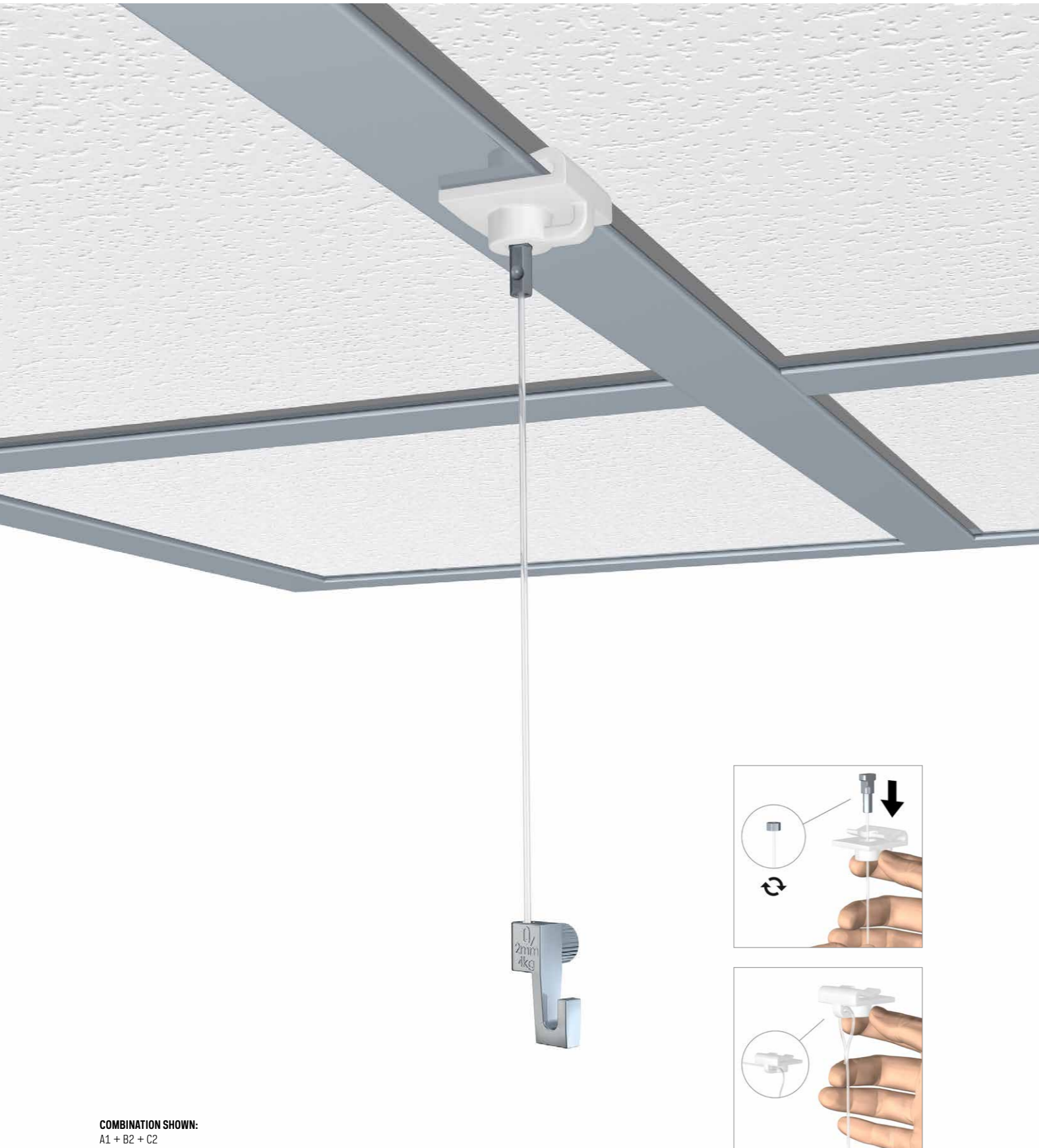

COMBINATION SHOWN:
A1 + B2 + C2

POSSIBLE COMBINATIONS:
A1 + B3 + C2
A1 + B2 + C2
A1 + B1 + C1
A1 + B4 + C2

RECESSED CEILING CLIP

A

A1



RECESSED CEILING CLIP ECO WHITE (MAX. 1KG)

7807.125

A2 **NEW**



RECESSED CEILING CLIP ECO BLACK (MAX. 1KG)

7807.126

B

B1



TWISTER 1 mm PERLON	
30.21150	150 cm
30.21200	200 cm
30.21300	300 cm

B2



TWISTER 2 mm PERLON	
09.23100	100 cm
09.23150	150 cm
09.23200	200 cm
09.23250	250 cm
09.23300	300 cm
09.23500	500 cm

B3



SLIDER ECONOMY 2 mm PERLON	
9.4424	100 cm
9.4425	150 cm
9.4426	200 cm
9.4427	250 cm
9.4428	300 cm

B4



PERLONWIRE 2 mm SPOOL	
9.4404	100 cm
9.4421S	500 cm
WIRE CLAMP 2mm ALU	
9.4431	

C

C1



30.41100

AUTO GRIP

C2



9.4205

MINI HOOK

FOR MORE HOOKS SEE PAGE 66.

CEILING ACOUSTIC

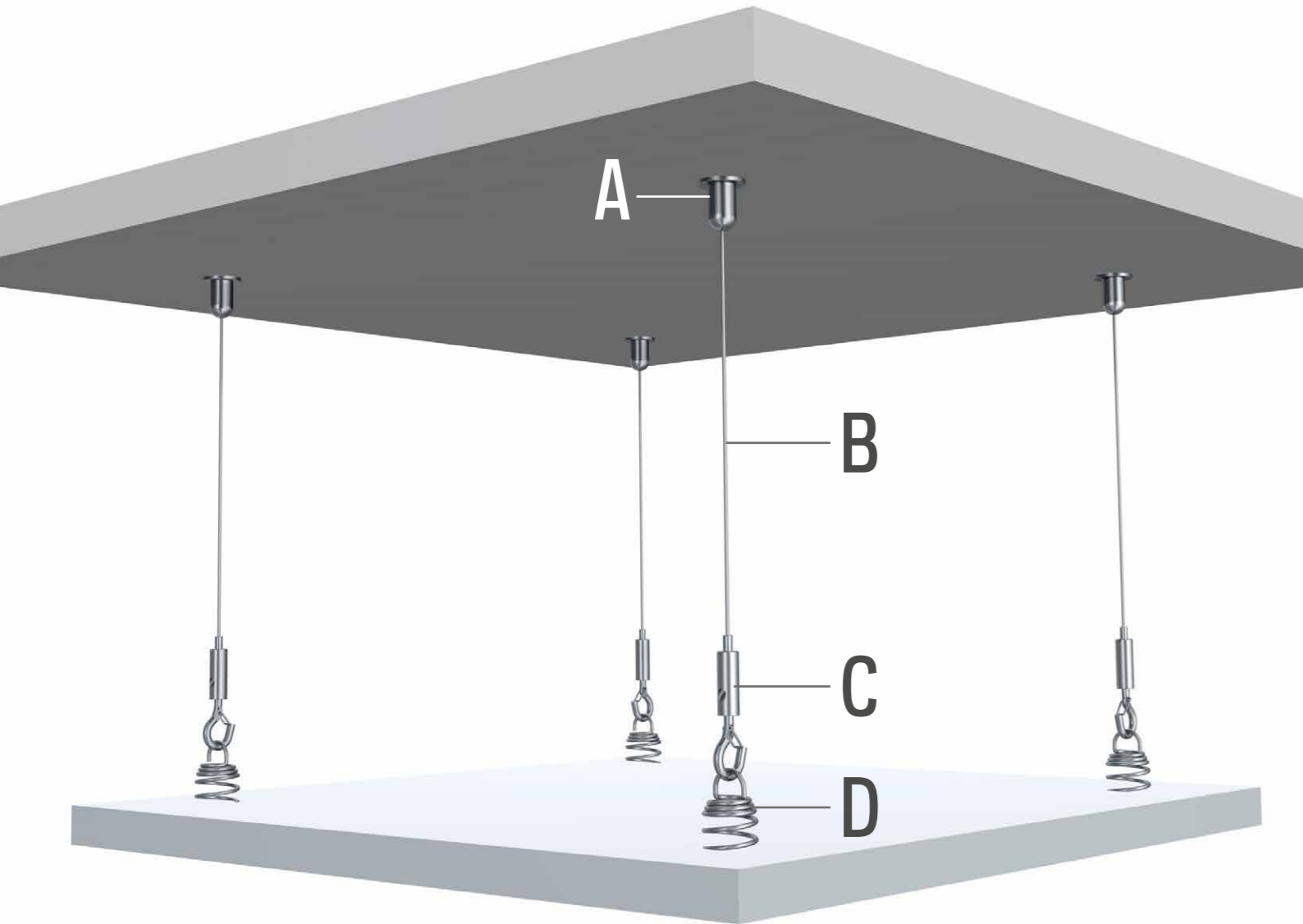

COMBINATION SHOWN:
A2 + B2 + C4 + D

POSSIBLE COMBINATIONS:
A1/A2 + B1/B2 + C1/C2/C3/C4 + D
A3 + B3/B4 + C1/C2/C3/C4 + D

CEILING ACOUSTIC

A	A1			A2			A3
CEILING BRACKET BLACK C01BL	FISCHER DUOPOWER 5X25 5 mm	SCREW 3,5 X 40 mm	CEILING BRACKET NICKEL C01NI	FISCHER DUOPOWER 5X25 5 mm	SCREW 3,5 X 40 mm	CEILING SUSPENSION AUTO GRIP 1,2 mm CS01NI	
7807.100	9.4934	9.4945	7807.110	9.4934	9.4945	7807.140	

B	B1	B2	B3	B4
STEELWIRE + SLIDER 1,2 mm 300 cm BLACK	STEELWIRE + SLIDER 1,2 mm 300 cm NICKEL	STEELWIRE 7 x 7 1,2 mm 10 m*	STEELWIRE BLACK 7 x 7 1,2 mm 3 m*	
7807.200	7807.210	7807.350	7807.360	

C	C1	C2	C3	C4
STEELWIRE HOOK AUTO GRIP 1,2 mm ST01BL	STEELWIRE HOOK AUTO GRIP 1,2 mm ST01NI	STEELWIRE HOOK AUTO GRIP 1,2 mm ST02NI	STEELWIRE HOOK AUTO GRIP 1,2 mm ST03NI	
7807.010	7807.020	7807.030	7807.040	

D
ACOUSTIC SPRING 01-NI
7807.400

* CABLE CUTTER 7807.900 AVAILABLE FOR USE WITH STEELWIRE 7 x 7 1,2mm

LOOP HANGER

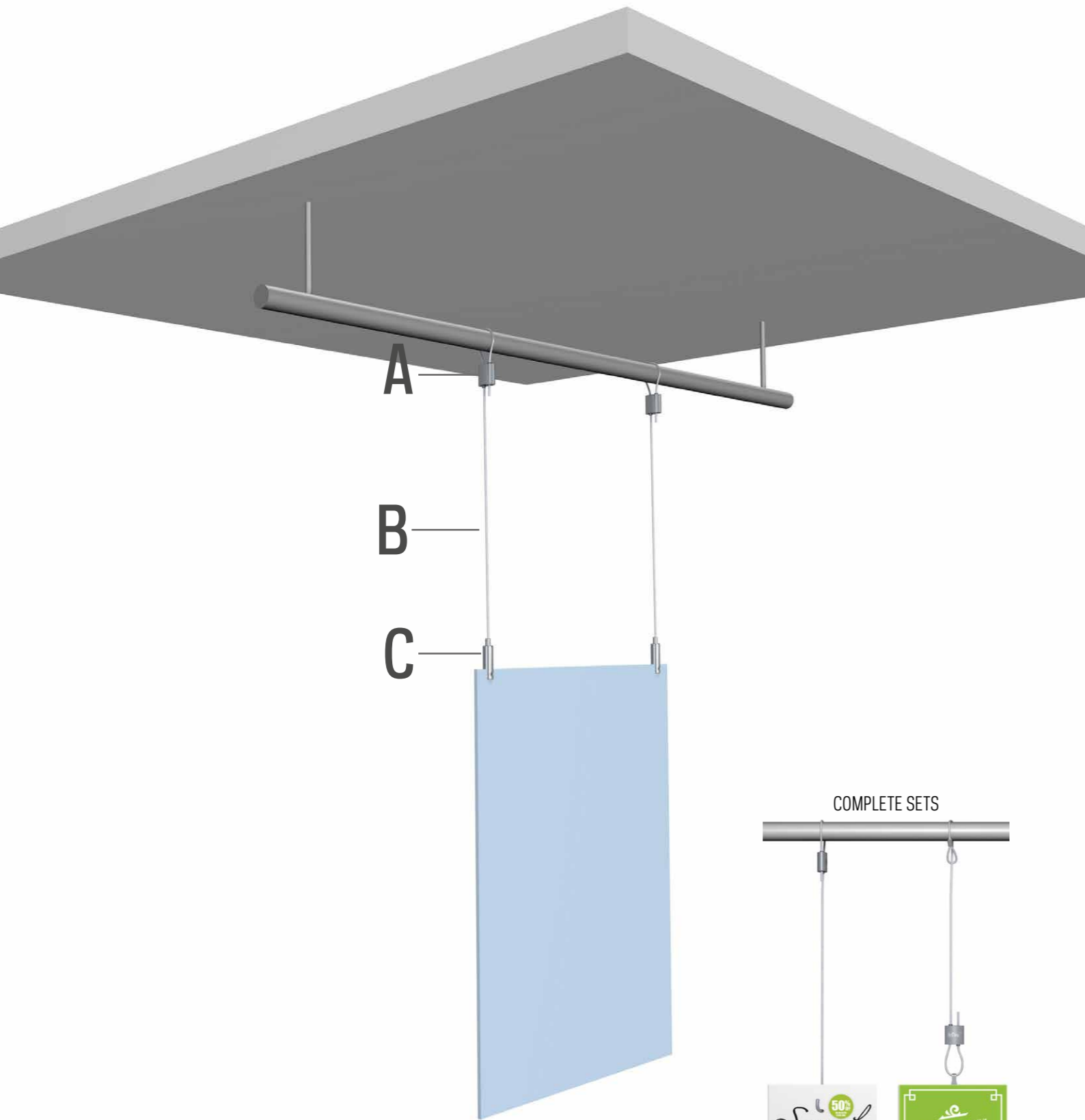

COMBINATION SHOWN:
A + B1 + C5

POSSIBLE COMBINATIONS:
A + B1/B2 + C1/C2/C3/C4/C5/C6/C7



LOOP HANGER

A



B



C

C1	C2	C3	C4	C5	C6	C7
STEELWIRE HOOK AUTO GRIP 1,2 mm ST01BL	STEELWIRE HOOK AUTO GRIP 1,2 mm ST01NI	STEELWIRE HOOK AUTO GRIP 1,2 mm ST02NI	STEELWIRE HOOK AUTO GRIP 1,2 mm ST03NI	STEELWIRE CLAMPHOOK AUTO GRIP 1,2 mm STC01NI	STEELWIRE HOOK AUTO GRIP 1,2mm STD01NI NICKEL	STEELWIRE HOOK AUTO GRIP 1,2mm STD01BL BLACK
7807.010	7807.020	7807.030	7807.040	7807.050	7807.080	7807.070

D



* CABLE CUTTER 7807.900 AVAILABLE FOR USE WITH STEELWIRE 7 x 7 1,2mm

SIGN HANGING SYSTEMS

Artiteq has selected the Fischer UX 5x30 R plug to be used in combination with its hanging systems. The Fischer UX 5x30 R plug can be used in different kinds of materials, such as concrete, stone and plasterboard. Depending on the material, the plug can support a maximum load of **30 kg**. The drill used with the plug must have a diameter of 5 mm. The plug is 30 mm in length. The screw used with the plug is 38 mm long and has a diameter of 3.5 mm (to be used in combination with a PZ2 bit).

To determine the maximum load of a signing hanging system, it must be known what type of mounting materials will be used and what surface (i.e. type of material) these will be attached to. The components of the signing hanging system all have a maximum bearing capacity. This is the maximum bearing capacity for the component itself and not the maximum bearing capacity that must be taken into account for the system as a whole. For the whole system, the load capacity that is recommended for the mounting material in combination with the respective base material, takes precedence.

For every signing hanging system, the weight that you wish to hang must be balanced against the maximum load capacity of the mounting material. If systems are hung from other hanging components, such as recessed ceilings, you have to know the maximum load of this hanging component before fitting our systems. The tables below show the maximum load capacity for the Fischer plug in combination with different materials and the maximum bearing capacity for each component for the different signing hanging systems.

DUOPOWER		5 X 25	
Highest recommended loads ¹⁾ for a single anchor. The given loads are valid for wood screws with the specified diameter.			
Wood screw diameter	[mm]	4	
Min. edge distance concrete	C_{min} [mm]	30	
RECOMMENDED LOADS IN THE RESPECTIVE BASE MATERIAL F_{REC}²⁾			
Concrete	≥ C20/25	[kN]	0,40
Solid brick	≥ Mz 12	[kN]	0,30
Solid sand-lime brick	≥ KS 12	[kN]	0,50
Aerated concrete	≥ AAC 2 (G2)	[kN]	0,05
Aerated concrete	≥ AAC 4 (G4)	[kN]	0,25
Vertically perforated brick	≥ Hlz 12 (ρ ≥ 0,9 kg/dm ³)	[kN]	0,13
Perforated sand-lime brick	≥ KSL 12 (ρ ≥ 1,6 kg/dm ³)	[kN]	0,40
Gypsum block	(ρ ≥ 0,9 kg/dm ³)	[kN]	0,10
Gypsum fibreboard	12,5 mm	[kN]	0,24
Gypsum plasterboard	12,5 mm	[kN]	0,12
Gypsum plasterboard	2 x 12,5 mm	[kN]	0,13
Matrone Forato Typ F8		[kN]	0,30
Tramezza Doppio UNI 19		[kN]	0,15
Sepa Parpaing		[kN]	0,30

¹⁾ Required safety factors are considered.
²⁾ Valid for tensile load, shear load and oblique load under any angle.
³⁾ Load determination on plastered wall.



ART. NO.	DESCRIPTION	MAX. CAPACITY
7805.052	Loop Hanger 1,0 mm - 1,5 mm	10 kg
7807.060	Suspension bracket Xpo Rail 1,2 mm	15 kg
7807.200	Steelwire + slider 1,2 mm 300 cm black	15 kg
7807.210	Steelwire + slider 1,2 mm 300 cm nickel	15 kg
7807.100	Ceiling bracket black C01BL	15 kg
7807.110	Ceiling bracket nickel C01NI	15 kg
7807.140	Ceiling suspension 1,2 mm CS01NI	15 kg
7807.150	Ceiling bracket auto grip 1,2 mm D01BL black	15 kg
7807.160	Ceiling bracket auto grip 1,2 mm D01NI nickel	15 kg
7807.350	Steelwire 7x7 1,2 mm 10 m	15 kg
7807.360	Steelwire black 7x7 1,2 mm 3 m	15 kg
7807.120	Recessed Ceiling Clip 24 mm white	5 kg
7807.121	Recessed Ceiling Clip 24 mm black	5 kg
7807.125	Recessed Ceiling Clip eco white	1 kg
7807.126	Recessed Ceiling Clip eco black	1 kg
7807.130	Recessed Ceiling Clip 20 mm + suspension auto grip 1,2 mm	5 kg
7807.135	Drop ceilinghanger	4 kg
7807.310	Steelwire + hook 1,2 mm 300 cm	15 kg
7807.010	Steelwire hook auto grip 1,2 mm ST01BL	15 kg
7807.020	Steelwire hook auto grip 1,2 mm ST01NI	15 kg
7807.030	Steelwire hook auto grip 1,2 mm ST02NI	15 kg
7807.040	Steelwire hook auto grip 1,2 mm ST03NI	15 kg
7807.050	Steelwire clamphook auto grip 1,2 mm STC01NI	15 kg
7807.070	Steelwire hook auto grip 1,2 mm STD01BL black	15 kg
7807.080	Steelwire hook auto grip 1,2 mm STD01NI nickel	15 kg
7807.400	Acoustic spring 01-NI	5 kg
7807.560	Drop ceiling clipphanger white	4 kg
7807.561	Drop ceiling clipphanger black	4 kg
9.4404	Perlon 2mm coil 100 m	15 kg
9.4421S	Perlon 2mm coil 500 m	15 kg
9.4431	Wire clamp 2 mm alu	15 kg



▶ SALES SUPPORT

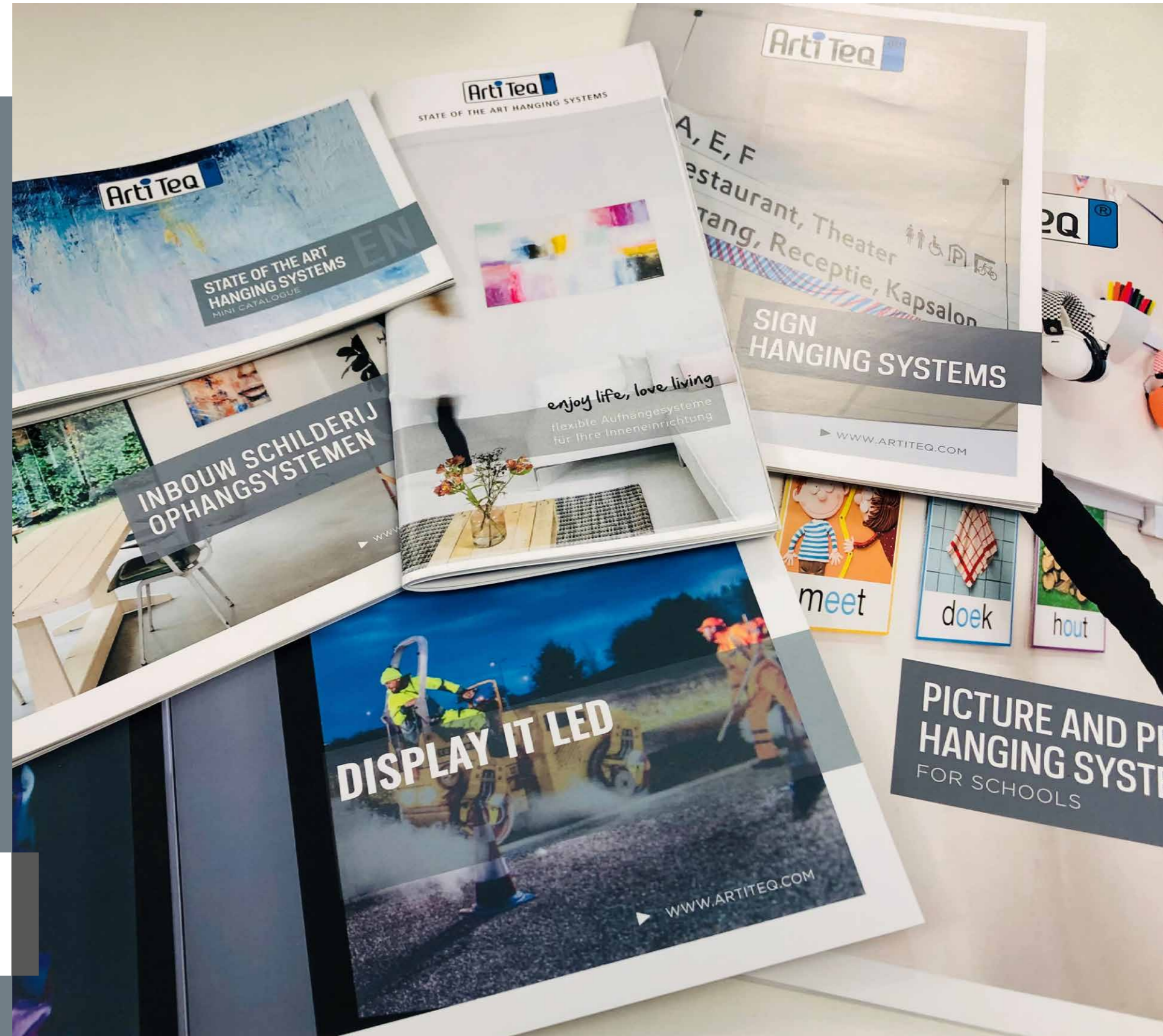

HIGH QUALITY
MULTIFUNCTIONAL
DESIGN

DISPLAYS & DEMONSTRATION TOOLS



DISPLAY HANGING SOLUTIONS MICRO GRIP		
3291C	DISPLAY HANGING SOLUTIONS MICRO GRIP	50x34x212 cm

CONTENT DISPLAY HANGING SOLUTIONS MICRO GRIP (3291C)		QUANTITY
9.7130	ALL-IN-ONE KIT 2 m CLICK MICRO GRIP RAIL WHITE PRIMER	12
9.7131	ALL-IN-ONE KIT 4 m CLICK MICRO GRIP RAIL WHITE PRIMER	8
9.7090	MICRO GRIP 2 mm (2X)	10
9.7091	TWISTER 2 mm PERLON 2mm 200 cm + MICRO GRIP 2 mm	10
9.7092	TWISTER 2 mm PERLON 2mm 200 cm (2X)	5
9.7093	INSTALLATION SET CLICK RAIL 2 m	5
9.7094	PICTURE MOUSE SOLO	5
9.7141	INFO RAIL RETAIL PACK WHITE 100 cm	5

CONTENT DISPLAY 3291C:

INFO RAIL RETAIL PACK



9.7141	INFO RAIL RETAIL PACK WHITE 100 cm
--------	------------------------------------

SEE PAGE 100 FOR INFO RAIL

CONTENT DISPLAY 3291C:

ALL-IN-ONE CLICK RAIL WHITE PRIMER TWISTER MICRO GRIP 20 KG HOOK

COMPLETE SET 2m

	1x 2m 	6x 	2x 	2x 150 cm max. 20 kg
	CLICK RAIL WHITE PRIMER RAL 9016	FASTENER MATERIAL	END CAP	MICRO GRIP 2 mm + TWISTER 2 mm PERLON
ARTICLE NO.	9.7130			

COMPLETE SET 4m

	2x 2m 	12x 	2x 	3x 150 cm max. 20 kg
	CLICK RAIL WHITE PRIMER RAL 9016	FASTENER MATERIAL	END CAP	MICRO GRIP 2 mm + TWISTER 2 mm PERLON
ARTICLE NO.	9.7131			

SEE PAGE 8 FOR CLICK RAIL

CONTENT DISPLAY 3291C:

ACCESSORIES RETAIL SETS

	9.7090	MICRO GRIP 2 mm (2x)
	9.7091	TWISTER 2 mm PERLON 200 cm + MICRO GRIP 2 mm
	9.7092	TWISTER 2 mm PERLON 200 cm (2x)
	9.7093	INSTALLATION SET CLICK RAIL 2 m
	9.7094	PICTURE MOUSE SOLO

DISPLAYS & DEMONSTRATION TOOLS



DISPLAY ART HANGING SOLUTIONS XS		
3290C	DISPLAY AHS XS	50 x 34 x 212 cm

CONTENT DISPLAY ART HANGING SOLUTIONS XS		QUANTITY
9.4348	CLICK RAIL WHITE PRIMER 200 cm	20
9.7051	END CAP WHITE (2x)	6
9.7053	CORNER CONNECTOR (2x)	6
9.7055	CLICK & CONNECT (6x) + SCREWS + PLUGS	6
9.7058	HOOK 15 kg (2x)	6
9.7075	HOOK 4 kg (2x)	6
9.7076	TWISTER 2 mm PERLON 200 cm (2x)	12
9.7082	HOOK 4 kg + TWISTER 2 mm PERLON 150 cm	6
9.7083	HOOK 15 kg + TWISTER 2 mm PERLON 150 cm	6
9.7162	ALL-IN-ONE KIT CLICK RAIL WHITE PRIMER 200 cm	12
	BROCHURE	25
3290	DISPLAY	1

ACCESSOIRES RETAIL SETS



9.7051	END CAP WHITE (2x)
9.7053	CORNER CONNECTOR (2x)
9.7055	CLICK & CONNECT (6x) + SCREWS+ PLUGS
9.7058	HOOK 15 kg (2x)
9.7075	HOOK 4 kg (2x)
9.7076	TWISTER 2 mm PERLON 200 cm (2x)
9.7077	TWISTER 2 mm STEELWIRE 200 cm (2X)
9.7080	HOOK 15 KG + TWISTER 2 mm STEELWIRE 150 cm
9.7082	HOOK 4 kg + TWISTER 2 mm PERLON 150 cm
9.7083	HOOK 15 kg + TWISTER 2 mm PERLON 150 cm

ALL-IN-ONE CLICK RAIL TWISTER 15 KG HOOK

RETAIL SETS

COMPLETE SET 2m

	1x 2m 	6x 	2x 	2x
	CLICK RAIL WHITE PRIMER RAL 9016	FASTENER MATERIAL	END CAP	HOOK 15 kg + TWISTER 2 mm PERLON
ARTICLE NO. 9.7162				

COMPLETE SET 2m

	1x 2m 	6x 	2x 	2x
	CLICK RAIL WHITE RAL 9010	FASTENER MATERIAL	END CAP	HOOK 15 kg + TWISTER 2 mm PERLON
ARTICLE NO. 9.7161				

COMPLETE SET 2m

	1x 2m 	6x 	2x 	2x
	CLICK RAIL ALU BRUSHED	FASTENER MATERIAL	END CAP	HOOK 15 kg + TWISTER 2 mm PERLON
ARTICLE NO. 9.7163				

COMPLETE SET 2m

	1x 2m 	6x 	2x 	2x
	CLICK RAIL ALU BRUSHED	FASTENER MATERIAL	END CAP	HOOK 15 kg + TWISTER 2 mm STEELWIRE
ARTICLE NO. 9.7164				

DISPLAYS & DEMONSTRATION TOOLS

DEMONSTRATION TOOLS



DEMONSTRATION BOARDS	
9.5730	DEMOBOARD CLICK RAIL PRO 50 x 130 cm
9.5731	DEMOBOARD COMBI RAIL PRO LIGHT 50 x 130 cm
9.5732	DEMOBOARD CLASSIC RAIL + CLASSIC RAIL+ 50 x 130 cm
9.5733	DEMOBOARD DECO RAIL 50 x 130 cm
9.5735	DEMOBOARD DISPLAY IT FIXED + FLEX 50 x 130 cm
9.5738	DEMOBOARD PICTURE MOUSE SOLO DISPLAY IT SOLO SET 50 x 130 cm
9.5739	DEMOBOARD WHITEBOARDSET + PARTITION WALL HOOKS 50 x 130 cm
9.5740	DEMOBOARD CONTOUR RAIL 50 x 130 cm
9.5741	DEMOBOARD LOOP HANGER 50 x 130 cm
9.5742	DEMOBOARD INFO RAIL + INFO RAIL ACCESSORIES 50 x 130 cm
9.5743	DEMOBOARD CLICK FRAMES + POSTER SNAP 50 x 130 cm
9.5745	DEMOBOARD SHADOWLINE 50 x 130 cm
9.5747	DEMOBOARD TOP RAIL + UP RAIL 50 x 130 cm
9.5748	DEMOBOARD INFO RAIL PLUS + INFO RAIL MAGNETIC

FLOORDISPLAY (DOUBLE-SIDED)	
3324	DISPLAY (150 cm HEIGHT, 40 cm WIDTH)
CHOOSE 2 PANELS:	
9.5801	PICTURE HANGING SYSTEMS - WALL SYSTEMS
9.5802	PICTURE HANGING SYSTEMS - CEILING/INTEGRATED SYSTEMS
9.5803	PICTURE HANGING SYSTEMS - FRAME ACCESSORIES
9.5804	SIGN HANGING SYSTEMS
9.5806	SIGN HANGING SYSTEMS - RAIL
9.5807	PICTURE HANGING SYSTEMS - SOLO SYSTEMS
9.5809	PRESENTATION SYSTEMS - DISPLAY IT LED FLEX
9.5810	PRESENTATION SYSTEMS - DISPLAY IT LED FIXED



DISPLAYS & DEMONSTRATION TOOLS

DEMONSTRATION TOOLS

SAMPLE BOX		
3246	BACK FRAME HANGING SYSTEM	
3259	PICTURE HANGING SYSTEMS	32 x 23 x 3 cm
7790.100	DISPLAY IT LED	56 x 43 x 6 cm



DEMONSTRATION CASE		
5038	DEMONSTRATION CASE + SET 3 INLAYS WITH SAMPLES	58 x 40 x 12 cm
3244	SIGN HANGING SYSTEMS	30 x 22 x 5 cm



BROCHURES

ARTICLE NO.	DESCRIPTION
2740	ARTITEQ PRODUCT CATALOGUE NL
2741	ARTITEQ PRODUCT CATALOGUE EN
2490	BROCHURE FOR SCHOOLS NL
2491	BROCHURE FOR SCHOOLS EN
2494	BROCHURE INTEGRATED SYSTEMS NL
2495	BROCHURE INTEGRATED SYSTEMS EN
2685	BROCHURE BACK FRAME HANGING SYSTEM NL
2686	BROCHURE BACK FRAME HANGING SYSTEM EN

ARTICLE NO.	DESCRIPTION
3746	BROCHURE ENJOY LIFE LOVE LIVING NL
3747	BROCHURE ENJOY LIFE LOVE LIVING EN
3748	BROCHURE ENJOY LIFE LOVE LIVING FR
3450	BROCHURE ENJOY LIFE LOVE LIVING DE
2725	BROCHURE DISPLAY IT LED NL
2726	BROCHURE DISPLAY IT LED EN
1059	MINI CATALOGUE
2700	BROCHURE ARTITEQ SIGN HANGING SYSTEMS NL
2701	BROCHURE ARTITEQ SIGN HANGING SYSTEMS EN

ARTITEQ ONLINE

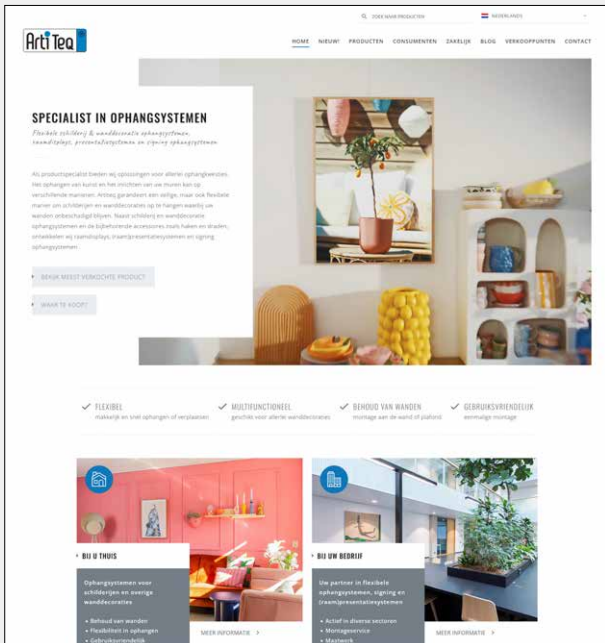

Find our products and information on our website!

- Our range of products can almost all be found on our website www.artiteq.com
- The products are divided into 3 segments: Picture hanging systems, Display hanging systems and Sign hanging systems.
- Are you looking for technical information, product sheets, brochures or installation instructions? These can all be found on the product page itself of the respective product.
- For inspiration, tips and market related stories and more visit www.artiteq.com/blog



To our website



To our blogs

Extensive image bank

- All images, installation manuals, technical sheets, technical drawings, line drawings, brochures, leaflets, installation videos or other videos can be downloaded from our own image bank!
- New images and other information that may be relevant and useful to you are regularly added to the image bank.
- Go to <https://artiteq.mediafiler.net/> and create your own account and password. We will approve it after which access is granted to the image bank.

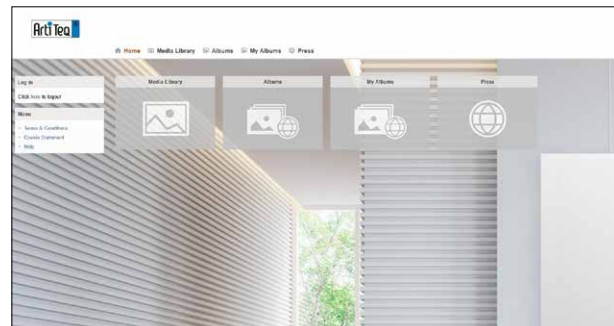

To our image bank

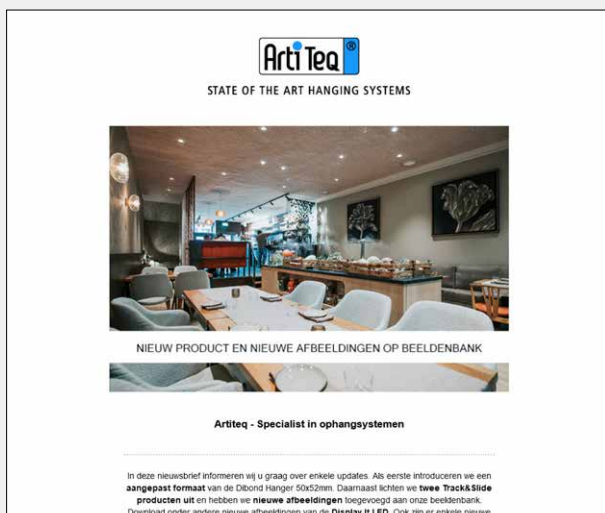

Stay informed!

- Every month a newsletter is sent in Dutch, English, German and French to our customers.
- The newsletters inform you about new products, new images that are available on the image bank, certain products are highlighted and we inform you about any changes or products that are going out of stock.
- Sign up for the newsletter to stay informed.



10 year warranty & TÜV certified

- We use TÜV quality assurance on our hanging systems, hanging wires and hooks.
- A TÜV seal of approval is confirmation that a product meets quality requirements, is safe and/or environmentally responsible.
- On all our products we give a standard warranty of 10 years. With the exception of electrical components, for which a 2-year warranty applies.



Read more about this

Social and societal contribution

- For more than 20 years, we have been working closely with the Diamond Group. In this way, we contribute to making people with a distance to the working world feel part of society.
- A large part of our production lies with the Diamond Group.



Read more about this



We like to tell you how sustainable Artiteq is!

- Our picture hanging systems are made of aluminium, which for a large part consists of recycled aluminium. In end-use aluminium is especially durable. Aluminium lasts for decades and is low-maintenance.
- At our factory, we try to reuse (residual) materials and parts of products for new products. Waste created during production is separated and recycled.
- We ship our products in cardboard boxes made from recycled materials and padded with recycled cardboard.
- In recent years, we have reduced plastic packaging. The products packaged in plastic is all rPET - recycled

plastic. rPET is considered one of the most environmentally friendly packaging materials. It is made from previously used PET plastic.



Read more about this

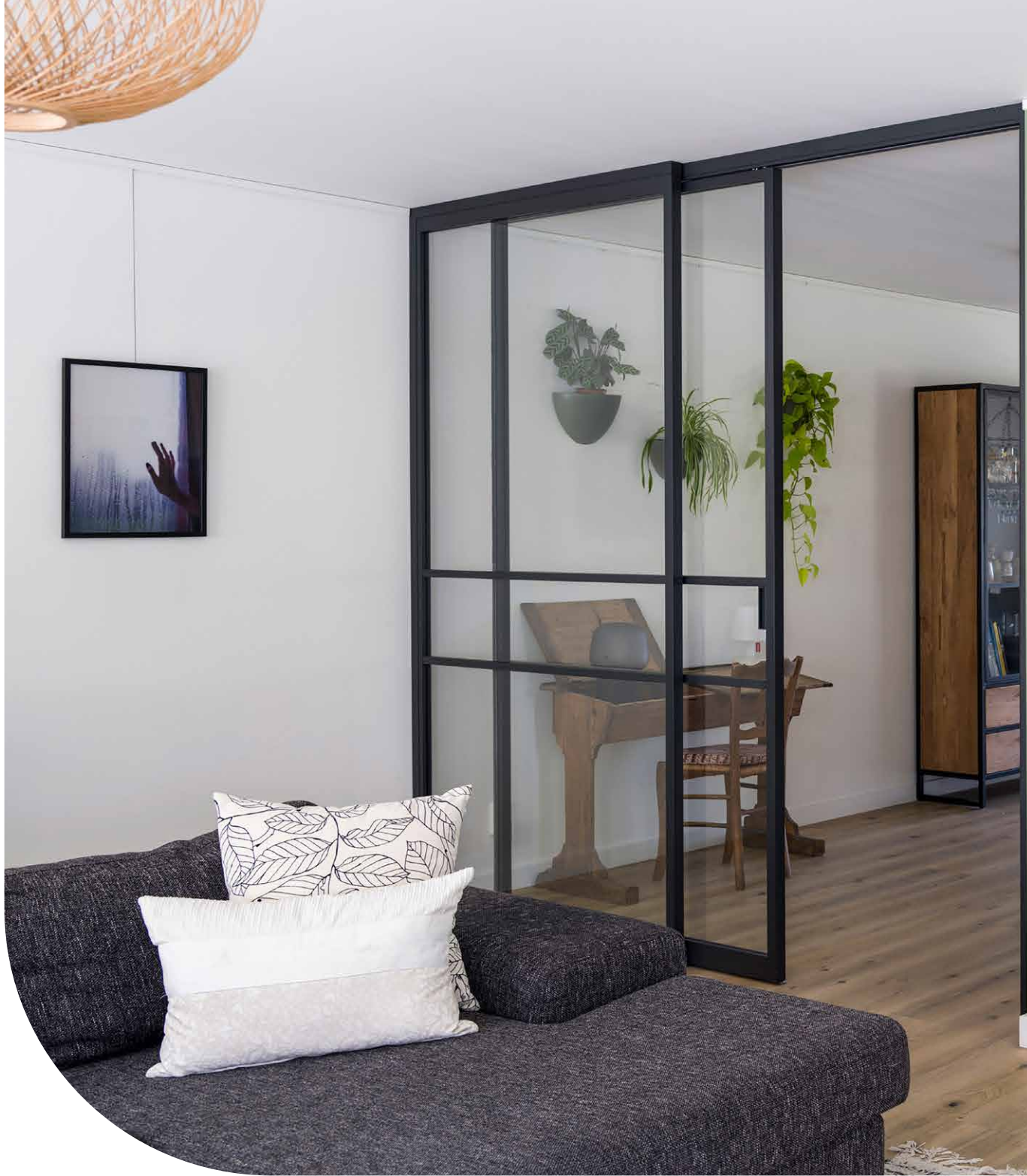

ARTITEQ

Herastraat 39
5047 TX Tilburg
The Netherlands

+31 (0)13 572 90 70
info@artiteq.com
artiteq.com