

Artiteq[®]

PRODUCT CATALOGUE
2026

ABOUT ARTITEQ

Artiteq's smart, sustainable hanging and display systems transform every wall into a limitless canvas. For almost 30 years, our family business has inspired art connoisseurs, interior décor enthusiasts and companies around the world to give every space its own ambience and energy. Our solutions are both functional and stylish, whether you wish to create a cosy homely atmosphere, have artistic freedom, create an interior to guarantee maximum impact, or ensure effective routing.

In 1995 we took the first small step of our adventure, at home in the garage of founder Jan van Boxtel. Today we are active in more than 80 countries and sectors. You will find us in DIY stores, in the education and property remodelling sectors and in art galleries. Our product range now also includes window displays, display systems and signing hanging systems, always underpinned by quality, flexibility and creativity.

Our family culture ensures that everyone feels welcome and can rely on one another. This enables us to perform at the highest possible level, with continuous improvement. We work closely with distributors and dealers throughout the world, we support them with marketing, training and reliable deliveries and we focus on innovation and sustainability.

Sustainability and social return are our core values. Because we want to give something back. This is why we assemble locally along with the Diamant group, that offers sheltered employment to people who are disadvantaged in the labour market. Sustainability is a top priority when our products are being developed, with smart logistics and the use of recycled ocean plastic. We haven't yet achieved our ultimate goals, but continually take steps towards these.



meet our
company



10 YEAR WARRANTY & TÜV CERTIFIED

We use TÜV quality assurance on our hanging systems, hanging wires and hooks. A TÜV seal of approval is confirmation that a product meets quality requirements, is safe and/or environmentally responsible. On all our products we provide a standard warranty of 10 years. With the exception of electrical components, for which a 2-year warranty applies.

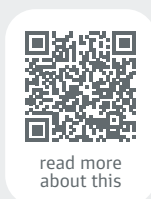

SOCIAL AND SOCIETAL CONTRIBUTION

For more than 20 years, we have been working closely with the Diamond Group. In this way, we contribute to making people with a distance to the working world feel part of society. A large part of our production is at the Diamond Group.



WE LIKE TO TELL YOU HOW SUSTAINABLE ARTITEQ IS!

- Our picture hanging systems are made of aluminium, which for a large part consists of recycled aluminium. In end-use aluminium is especially durable. Aluminium lasts for decades and is low-maintenance.
- At our factory, we try to reuse (residual) materials and parts of products for new products. Waste created during production is separated and recycled.
- We ship our products in cardboard boxes made from recycled materials and padded with recycled cardboard.
- In recent years, we have reduced plastic packaging. The products packaged in plastic is all rPET - recycled plastic. rPET is considered one of the most environmentally friendly packaging materials. It is made from previously used PET plastic.

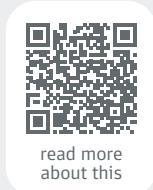

CONTENT

Picture hanging systems

- Wall hanging systems modern 10
- Wall hanging systems modern + LED 26
- Wall hanging systems traditional 30
- Ceiling hanging systems 40
- Integrated hanging systems 50
- Fastener material 60
- Hanging wires and hooks 64
- Solo systems 80
- Frame accessories secured 94 
- Frame accessories 108
- Panel hanging systems Back Frame 112
- Panel hanging systems 116
- Tile / plate hanging systems 118

Display hanging systems

- Cable hanging systems 120
- Rail hanging systems 136

Sign hanging systems

- All-in-one sets 148
- Sales support 168
- Artiteq online 174
- 182

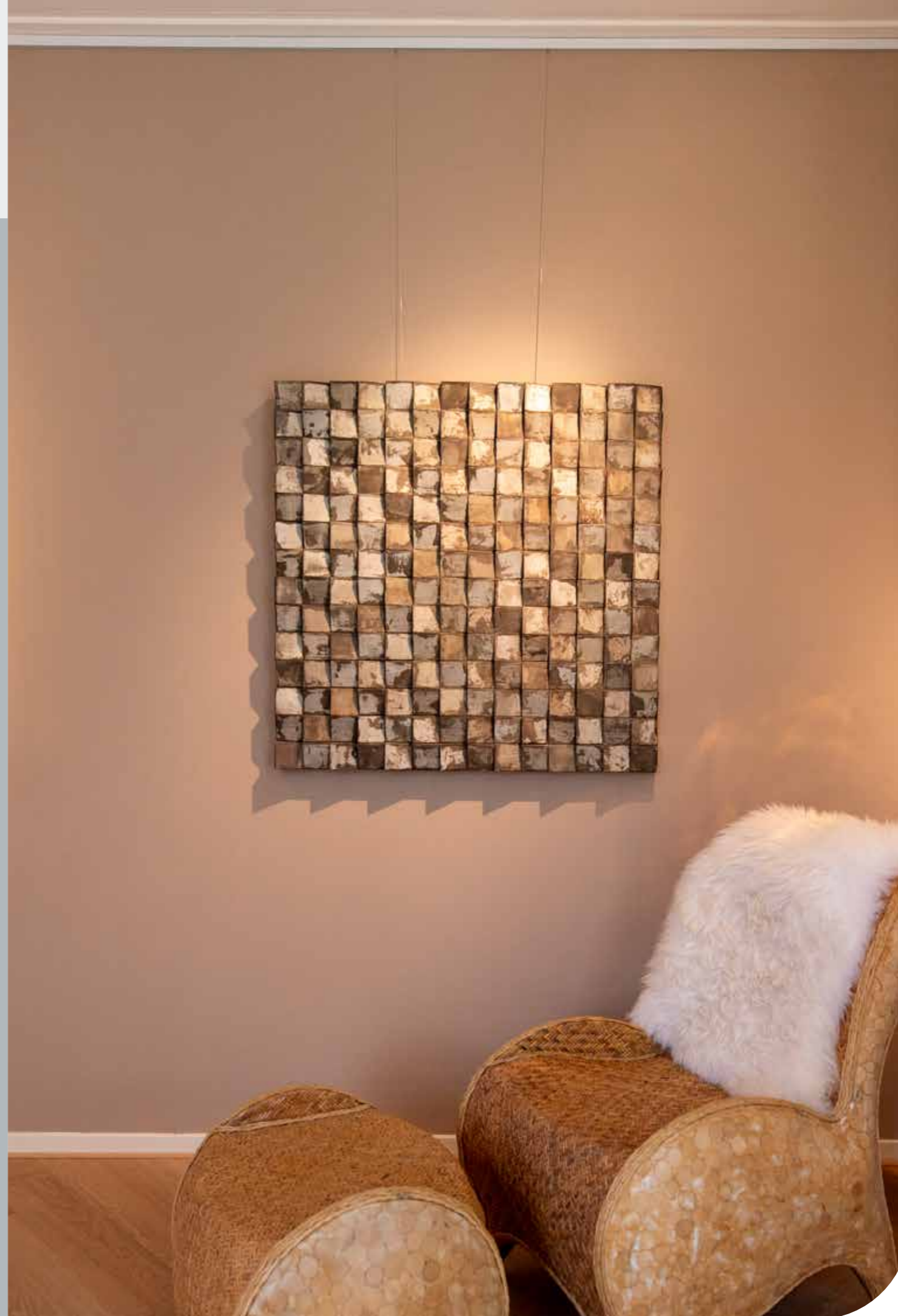

OVERVIEW RAIL SYSTEMS

For every wall or interior there is a suitable hanging system to be found within Artiteq's range. When choosing a picture hanging system, there are several factors to consider. First, you need to determine where the system should and may be mounted, namely on the wall or on the ceiling. In addition, the stage of construction or interior plans and your personal taste and any specific requirements also play a role in the choice.

Each track system has maximum load capacity, design features, lengths and colour options. It is important to consider these aspects when making your choice. In this way, you can ensure that the hanging system perfectly suits your needs and aesthetic preferences.

Below you will find an overview that clearly shows these features. This way, you can easily select the right hanging system to suit your specific situation.

At Artiteq, we understand that every project is unique, which is why we offer a wide range of hanging solutions. Whether you are looking for a simple rail system for your artwork at home, or a more advanced system for professional use, we have the right solution for you.







WALL HANGING SYSTEMS MODERN								
	Contour Rail Glued	Contour Rail	Newly R10 Rail	Newly R20 Rail	Click Rail	Click Rail Pro	Double Wall Track	Newly R70 Rail
WEIGHT CAPACITY (per meter)	10 kg p/m	20 kg p/m	20 kg p/m	30 kg p/m	30 kg p/m	50 kg p/m	80 kg p/m	100 kg p/m
SIZE RAIL								
INSTALLATION	wall, flush against ceiling	wall, 15 cm under ceiling	wall, flush against ceiling	wall, flush against ceiling	wall, flush against ceiling	wall, flush against ceiling	wall	wall, flush against ceiling
AVAILABLE COLOURS					White RAL 9010	White RAL 9010	White RAL 9010	
	White Primer RAL 9016	White Primer RAL 9016	White Primer RAL 9016	White Primer RAL 9016	White Primer RAL 9016		White Primer RAL 9016	White Primer RAL 9016
			Aluminium	Aluminium	Aluminium	Alu Brushed	Aluminium	Aluminium
			Black		Black		Black	
AVAILABLE LENGTH	200 cm 300 cm	200 cm 300 cm	200 cm 300 cm	200 cm 300 cm	150 cm 200 cm 300 cm 600 cm	200 cm 300 cm	200 cm	200 cm

WALL HANGING SYSTEMS TRADITIONAL				
	Classic Rail	Classic Rail+	Newly R30 Rail	Heavy Duty Track Wall
WEIGHT CAPACITY (per meter)	20 kg p/m	40 kg p/m	40 kg p/m	200 kg p/m
SIZE RAIL				
INSTALLATION	wall	wall	wall	wall, integrated or flush against ceiling
AVAILABLE COLOURS	White RAL 9010	White RAL 9010		White RAL 9010
	White Primer RAL 9016		White Primer RAL 9016	
	Aluminium	Alu Brushed		Any Colour On Request
	Black	Black		
AVAILABLE LENGTH	200 cm 300 cm	200 cm 300 cm	200 cm 300 cm	100 cm 200 cm

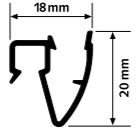
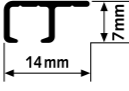
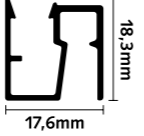

WALL HANGING SYSTEMS MODERN LED		
	Newly R35 Rail LED	Illume Duo Rail
WEIGHT CAPACITY (per meter)	30 kg p/m	60 kg p/m
SIZE RAIL		
INSTALLATION	wall, min. 10cm under ceiling	
	10 mm	
AVAILABLE COLOURS	White Primer RAL 9016	White RAL 9010
		Black
AVAILABLE LENGTH	200 cm	200 / 300 cm

OVERVIEW RAIL SYSTEMS

CEILING HANGING SYSTEMS

				
WEIGHT CAPACITY (per meter)	20 kg p/m	20 kg p/m	20 kg p/m	200 kg p/m
SIZE RAIL				
INSTALLATION	ceiling	ceiling	ceiling	ceiling
AVAILABLE COLOURS	White RAL 9010	White RAL 9003	White Primer RAL 9016	White RAL 9010
		Alu Brushed		Any Colour On Request
	Black	Black		
AVAILABLE LENGTH	200 cm 300 cm	200 cm 300 cm	200 cm	100 cm 200 cm

INTEGRATED HANGING SYSTEMS

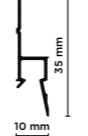
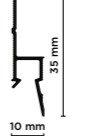
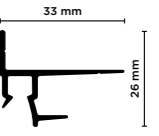
				
WEIGHT CAPACITY (per meter)	20 kg p/m	20 kg p/m	20 kg p/m	20 kg p/m
SIZE RAIL				
INSTALLATION	wall*	wall*	integrated drywall	integrated
AVAILABLE COLOURS	White Primer RAL 9016	White Primer RAL 9016	White Primer RAL 9016	White Primer RAL 9016
AVAILABLE LENGTH	200 cm	200 cm	200 cm	200 cm

*mount on wall, determine own height for desired lighting effect

PICTURE HANGING SYSTEMS

WALL HANGING SYSTEMS

Wall modern

Contour Rail Glued	10 kg
Contour Rail	20 kg
Newly R10 Rail	20 kg
Newly R20 Rail	30 kg
Click Rail	30 kg
Click Rail Pro	50 kg
Double Wall	80 kg
Newly R70 Rail	100 kg
Heavy Duty Track Wall	200 kg
Track & Wire	

Wall modern + LED

Newly R35 Rail LED	30 kg
Illume Duo Rail	60 kg

Wall traditional

Classic Rail	20 kg
Classic Rail plus	40 kg
Newly R30 Rail	40 kg

- flush against ceiling
- preservation of walls
- user-friendly



wall hanging systems modern
CONTOUR RAIL GLUED

10
 kg p/m



10
 YEAR
 WARRANTY

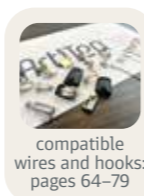
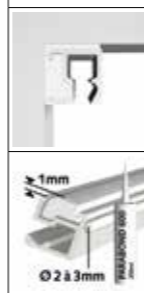

Contour Rail glued - hanging without drilling

Looking for a compact hanging rail that 'disappears' in a room? Contour Rail offers the solution: the rail can also be mounted to the ceiling using glue. Thanks to the special design, the glue may be applied in and on the profile in the desired manner. When the Contour Rail is glued and painted in the same colour as the wall, it becomes inconspicuous while still offering all the advantages of a flexible hanging system: the ability to hang and move pictures without damaging the walls.

RAIL



Contour Rail - White Primer RAL 9016		End Cap White
200 cm P/1*	300 cm P/1*	
ARTICLE NO. 30.11201	30.11301	30.31210

FASTENER MATERIAL



Contour Rail Glue Set (for fixation of 4,5-5m)	
3m Surface Cleaners & Glue Parabond 600 White 290 ml	
ARTICLE NO.	30.31180

* P/1: packaged by the piece in foil



wall hanging systems modern
CONTOUR RAIL

20
kg p/m

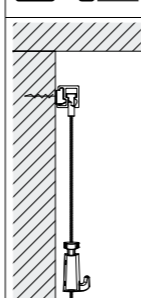
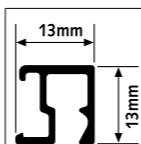

10
YEAR
WARRANTY



3 clips / m

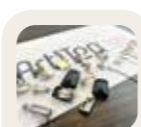

compatible
wires and hooks:
pages 64-79

Compact and attractive hanging system

"Less rail, more art". Contour Rail gets the job done in spite of its minimal dimensions, and has an attractive, sleek design. Hanging pictures, or hanging and moving framed photos is easy thanks to the Contour Rail. Using the clips, the picture rails may be mounted to the wall (minimum distance from the ceiling: 15 mm). In addition to the aluminium version of the rail, the available model in white may be painted in any colour. The refined style of the 1 mm Twister hanging wires with Micro Grip 1 mm suspension hook make them a perfect match for the compact shape of this hanging system.

RAIL



Contour Rail - White Primer RAL 9016

End Cap White

200 cm P/1*

30.11201

ARTICLE NO.

30.31310

ARTICLE NO.

30.11301

ARTICLE NO.

30.31330

ARTICLE NO.

30.31210

ARTICLE NO.

ARTICLE NO.

ARTICLE NO.

CONTENT FASTENER KIT



		Quantity 200 cm	Quantity 300 cm
30.31110	Click&Connect	6x	9x
9.4945	Screw	6x	9x
9.4934	Plug	6x	9x
30.31210 (White)	End Cap	2x	2x
2388	Instruction	1x	1x

All mounting material may be ordered separately. See overview on page 60.
* P/1: packaged by the piece in foil



installation
video

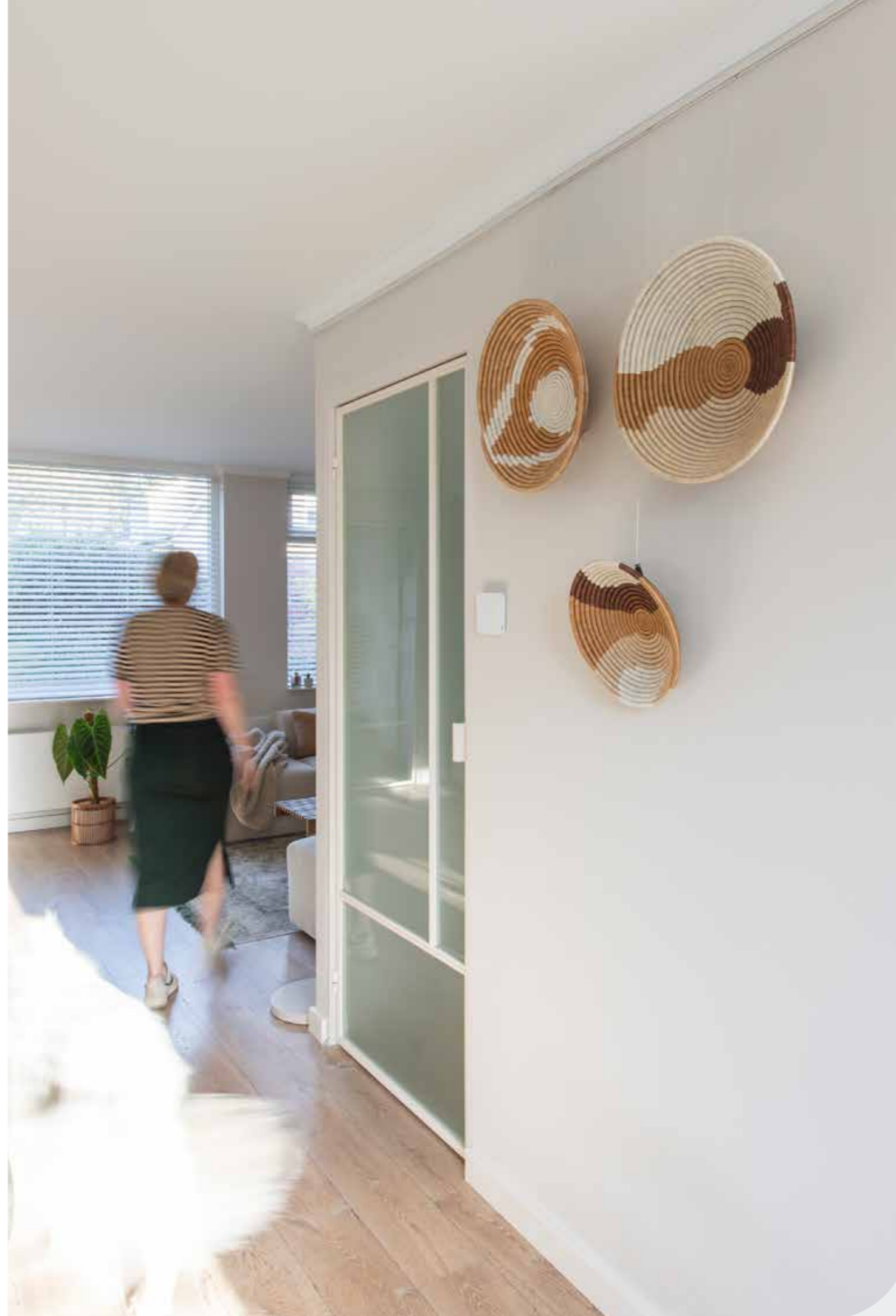

wall hanging systems modern
NEWLY R10 RAIL ⓘ

20
kg p/m



The Newly R10 Rail is a compact and stylish picture hanging rail that is easy to install thanks to its clever One-Click system. This allows the rail to be mounted quickly and securely to the wall, seamlessly connecting to the ceiling for a clean, minimalist finish. Available in white, silver, and black.

Thanks to its compact design, the rail is barely visible while still offering a professional and reliable hanging solution with a load capacity of 20 kg per meter.

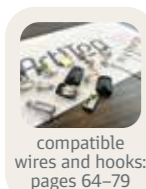

compatible wires and hooks: pages 64–79



installation video

A major advantage of the Newly rail systems is that the head of the Twister hanging cords is completely hidden inside the rail. Only the cord remains visible, creating a sleek, minimalist presentation, perfect for modern interiors, galleries, offices, or living spaces.

RAIL

	Newly R10 Rail - White Primer RAL 9016		Newly R10 Rail - Alu Anodized		Newly R10 Rail - Black	
	P/1*	P/10*	P/1*	P/10*	P/1*	P/10*
ARTICLE NO. 200 cm	1101.201	1101.200	1102.201		1103.200	
ARTICLE NO. 300 cm	1101.301	1101.300				
	Fastener Kit White		Fastener Kit Grey		Fastener Kit Black	
ARTICLE NO. 200 cm	4040.210		4040.211		4040.212	

All mounting material may be ordered separately. See overview on page 60.

wall hanging systems modern
NEWLY R20 RAIL ⓘ

30
kg p/m



The Newly R20 Rail is a discreet yet powerful picture hanging rail, ideal for the flexible display of paintings, frames, or other wall decorations. With a load capacity of 30 kg per meter, this rail offers extra stability and reliability while maintaining a subtle and streamlined design. Available in white and silver.

Thanks to the convenient One-Click system, the rail can be installed quickly and easily. The R20 is mounted directly onto the wall, flush with the ceiling, creating a continuous line that integrates seamlessly with any interior.

A key advantage of the Newly rail systems is that the head of the Twister hanging cords is completely hidden inside the rail. Only the cord remains visible, resulting in a sleek, minimalist presentation — perfect for modern interiors, galleries, offices, or living spaces.

RAIL

	Newly R20 Rail - White Primer RAL 9016		Newly R20 Rail - Alu Anodized	
	P/1*	P/10*	P/1*	P/10*
ARTICLE NO. 200 cm	1201.200		1202.200	
ARTICLE NO. 300 cm	1201.300			
	Fastener Kit White		Fastener Kit Grey	
ARTICLE NO. 200 cm	4040.220		4040.221	

All mounting material may be ordered separately. See overview on page 60.



installation video

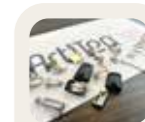

compatible wires and hooks: pages 64–79

wall hanging systems modern

CLICK RAIL

30
kg p/m

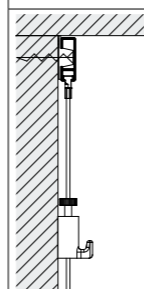
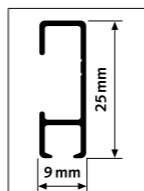

10
YEAR
WARRANTY



3 clips / m



compatible wires and hooks:
pages 64-79

The Click Rail is a flexible picture hanging system that you mount to the wall. Using the Click&Connect system, mounting the rail system is fast and easy. The Click Rail may be installed flush against the ceiling and may also be repainted, for example in the same colour as the wall or ceiling. This helps the picture hanging system 'blend in' with the wall or ceiling, making it nearly invisible. The hanging rail's appearance makes it easy to integrate in any room or interior. You always have flexibility in hanging posters, pictures or photo frames thanks to the hanging wires with hooks that you can hang into any desired location on the rail system.

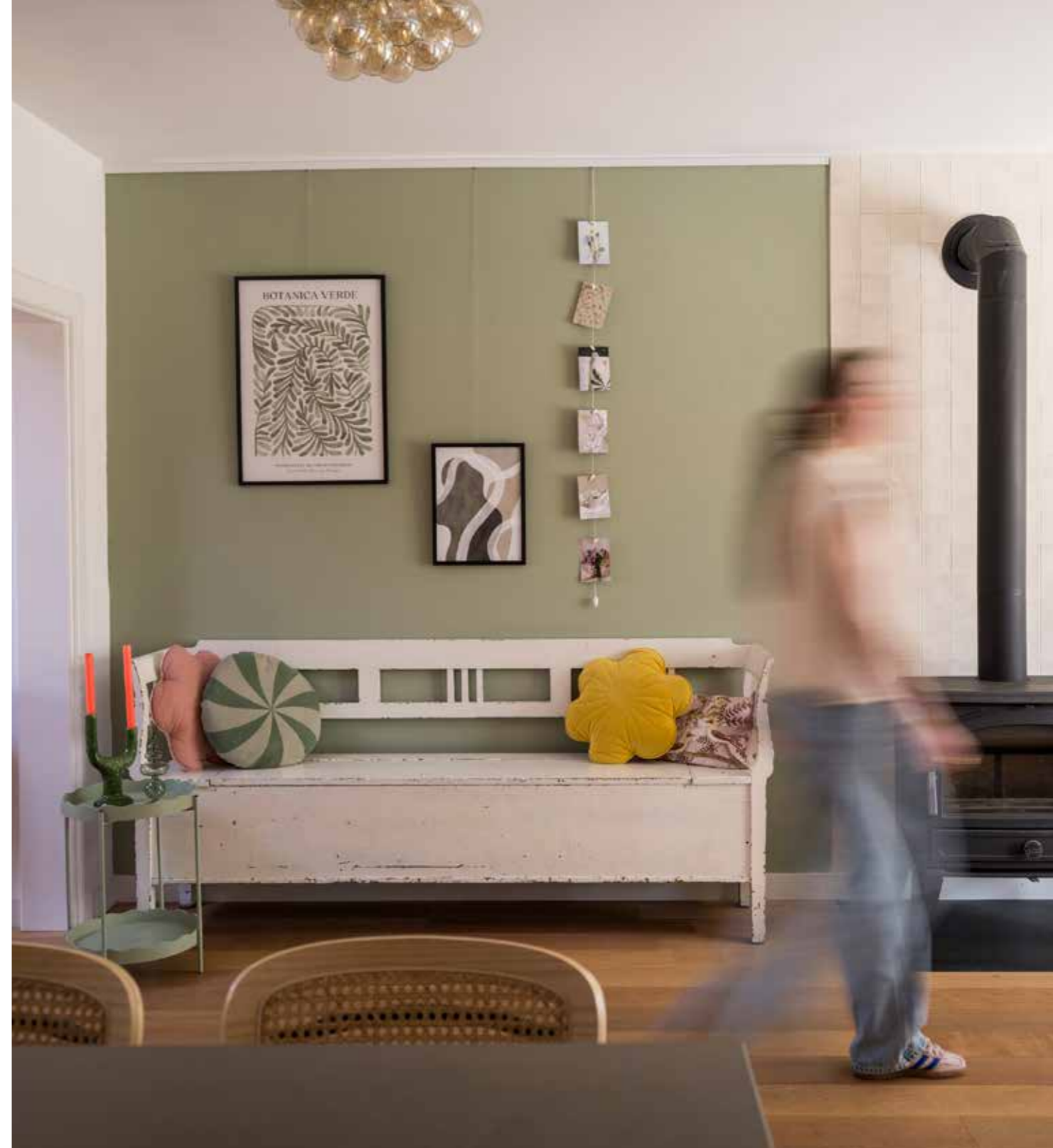

RAIL



	Click Rail - White RAL 9010		Click Rail - White Primer RAL 9016		Click Rail - Alu Brushed		Click Rail - Black Structure	
	P/1*	P/20*	P/1*	P/20*	P/1*	P/20*	P/1*	P/20*
ARTICLE NO. 150 cm				9.4360				
ARTICLE NO. 200 cm	9.4303	9.4353	9.4348	9.4350	9.4341	9.4340		05.01210
ARTICLE NO. 300 cm	9.4304	9.4354	9.4349	9.4351	9.4343	9.4342		05.01310
ARTICLE NO. 600 cm	9.4372		9.4346					
	Fastener Kit White		Fastener Kit White		Fastener Kit Grey		Fastener Kit Black	
ARTICLE NO. 200 cm	4065		4065		4064		5094	
ARTICLE NO. 300 cm	4061		4061		4060		5095	

CONTENT FASTENER KIT



installation video



		Quantity 200 cm	Quantity 300 cm
9.4113	Click&Connect	6x	9x
9.4945	Screw	6x	9x
9.4934	Plug	6x	9x
9.4105 (White) / 9.4104 (Grey) / 9.4112 (Black)	End Cap	2x	2x
9.4107 (White) / 9.4108 (Grey) / 9.4114 (Black)	Corner Connector	1x	1x
2386	Instruction	1x	1x

All mounting material may be ordered separately. See overview on page 60.
*P/1: packaged by the piece in foil / p/20: packaged per 20 in foil

wall hanging systems modern
CLICK RAIL PRO

50
kg p/m

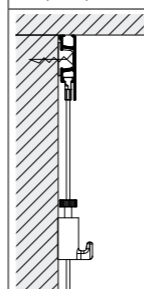
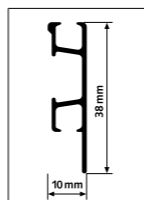

10
YEAR
WARRANTY



3 clips / m

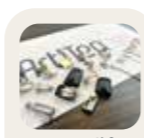

compatible
wires and hooks:
pages 64–79

The Click Rail Pro hanging system is the professional, heavy-duty version of the Click Rail. The rail is quick and easy to instal thanks to the Click&Connect clips, and can be mounted on the wall, flush against the ceiling. It is possible to mount the rail in such a way that the sliders for the hanging wire may be subtly hidden behind the rail. The Click Rail Pro picture hanging system has a maximum load capacity of 50 kg/m.

Hanging heavy pictures and wall decorations is no problem with the Click Rail Pro. Click Rail Pro is a strong picture hanging system that you can trust when it comes to hanging your art on the wall. The hanging wires may be moved and clicked into the rail again at any desired location. This assures you of flexibility in what you display on your walls. Moving or replacing a work of art is fast and easy, and there's no risk of damaging the walls.

RAIL



Click Rail Pro - White Primer
RAL 9016

Click Rail Pro - Alu Brushed

ARTICLE NO. 200 cm

05.05420

05.05320

ARTICLE NO. 300 cm

05.05430

05.05330

Fastener Kit White

Fastener Kit Grey

ARTICLE NO. 200 cm

4067

4066

ARTICLE NO. 300 cm

4074

4073

CONTENT FASTENER KIT



installation
video



		Quantity 200 cm	Quantity 300 cm
9.4124	Click&Connect	6x	9x
9.4945	Screw	6x	9x
9.4934	Plug	6x	9x
9.4120 (White) / 9.4121 (Grey)	End Cap	2x	2x
9.4122 (White) / 9.4123 (Grey)	Corner Connector	1x	1x
2387	Instruction	1x	1x

All mounting material may be ordered separately. See overview on page 60.



wall hanging systems modern
DOUBLE WALL TRACK 

 **80**
kg p/m

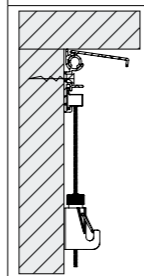
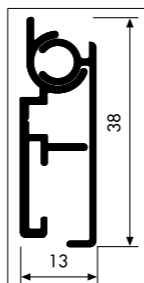

10
YEAR
WARRANTY



The Double Wall Track offers a smart and discrete way of hanging works of art, making it ideal for museums and exhibition spaces. This rail comprises two parts: a sturdy base rail that is attached to the wall and cover that is placed over it. Giving it a neat finish and providing a secure hanging solution without damaging the wall. The rail can be painted or select the Double Wall Track + cover special to custom rail in any RAL colour.





A special slider is used in combination with the Double Wall Track that easily hooks into the rail, can be placed at any position on the rail and can be secured. Slid the steel wire of 1.2 or 1.8 mm thick through the slider and combine with the Auto Grip Lock hook for hanging works of art of 15 to 40 kg (max. weight depends on which type of steel wire).

RAIL

			
Double Wall Track - White RAL9010	Double Wall Track - White Primer RAL9016	Double Wall Track - Silver Anodised	Double Wall Track - Black
TS00001	TS00001WH1	TS00001ANI	TS00001BL1

ARTICLE NO. 200 cm

Double Wall Track + cover special RAL colour 200 cm TS00001SR
The rail comes pre-drilled with mounting holes, starting 6 cm from one end and repeating every 23,5 cm along its 200 cm length.

			
End Cap Double Wall Track - White	End Cap Double Wall Track - Black	Fischer Plug Duopower 4,0 x 60 mm PH T20	Fastener kit 200 cm
TS00002	TS00002BL	6 x 50 mm screw TS00110 & TS00120	9x screws & plugs TS00100

ARTICLE NO.









SET SLIDER STAINLESS STEEL WIRE



	Slider + Stainless Steel Wire 1,2 mm	Slider + Stainless Steel Wire 1,8 mm	Slider + Stainless Steel Wire Black 1,8 mm
	P/1*	P/1*	
ARTICLE NO. 150 cm	TS80012Z15	TS80018Z15	-
ARTICLE NO. 200 cm	TS80012Z20	TS80018Z20	TS81018Z20
ARTICLE NO. 250 cm	TS80012Z25	TS80018Z25	-
ARTICLE NO. 300 cm	TS80012Z30	TS80018Z30	TS81018Z30
ARTICLE NO. 500 cm	TS80012Z50	TS80018Z50	TS81018Z50

All mounting material may be ordered separately. See overview on page 60.

			
	TS00218 15-40 kg	TS30218 15-40 kg	TS94620 15-40 kg
	Auto Grip	Track & Wire 1.2 - 1.8 mm	Frame Hanger Junior M 1.2 - 1.8 mm

	Lock		
			
1,2 mm Steelwire 150 / 200 / 300 cm			
			
1,8 mm Steelwire 150 / 200 / 300 cm			



wall hanging systems modern
NEWLY R70 RAIL 

 **100**
 kg p/m

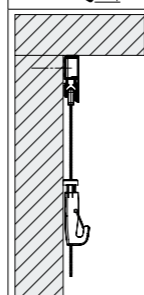
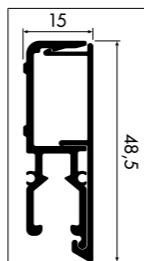

10
 YEAR
 WARRANTY



3 clips / m

The Newly R70 Rail is a premium quality, professional wall rail developed for spaces where strength, reliability and discretion matter most, such as museums, galleries, corporate collections and high-end residential interiors. Designed to support heavy artworks with confidence, the R70 brings together structural robustness and refined aesthetics.

The R70 is engineered to carry a weight capacity of up to 100 kg per meter. The rail is mounted flush against the wall and ceiling, keeping the profile clean and virtually invisible.

This system is compatible with the 2.5 mm steel Twister Lock cables and the full range of our 1 mm and 2 mm hanging wires, including perlon wires and steel cables, offering flexibility for displaying both heavier masterpieces and smaller works without unnecessary sway or tilt.



RAIL

			
Newly R70 Rail - White Primer RAL 9016	Newly R70 Rail Cover - White Primer RAL 9016	Newly R70 Rail - Silver	Newly R70 Rail Cover - Silver
P/1*	P/1*	P/1*	P/1*
ARTICLE NO. 200 cm	6110.200	6120.200	6115.200
	6125.200		
	Fastener Kit White	Fastener Kit Grey	
ARTICLE NO. 200 cm	6100.050	6100.050	

All mounting material may be ordered separately. See overview on page 60.



installation video



compatible wires and hooks: pages 64-79

COMPATIBLE WIRES



2.5 mm

	Twister Steel Wire Lock 2.5 mm
ARTICLE NO. 200 cm	6200.200
ARTICLE NO. 300 cm	6200.300
ARTICLE NO. 500 cm	6200.500



Auto Grip Lock 2.5 mm
6100.110
 100 kg

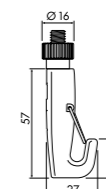

wall hanging systems modern LED
NEWLY R35 RAIL LED

30
kg p/m

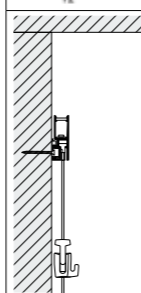
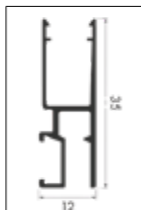

10
YEAR
WARRANTY



3 clips / m

The Newly R35 Rail LED is a premium aluminium rail featuring integrated dimmable LED lighting. Thanks to the One-Click system, it can be easily mounted directly onto the wall, at least 10 cm below the ceiling.

The rail comes with a special coating, allowing it to be painted in any desired colour. The Newly R35 Rail LED has a maximum load capacity of 30 kg per meter. Using the Newly hanging cords, paintings, posters, or other wall decorations can be safely and easily hung at any desired position along the rail.

The R35 Rail LED includes a diffuser and is suitable for LED strips up to 8 mm wide. The specially designed end caps ensure that the LED strip wiring can be neatly concealed.

A key advantage of the Newly rail systems is that the head of the Twister hanging cords is completely hidden inside the rail. Only the cord remains visible, resulting in a sleek, minimalist presentation.

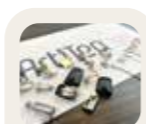

compatible wires and hooks: pages 64-79

RAIL

Newly R35 Rail LED + Diffuser - White Primer - RAL 9016	Diffuser 100 cm	LED Strip 60/m 25w 300 k	LED Driver 24 v	Remote Controller	LED Strip Extension Wire 200 cm	R35 End cap white + wire guide L+R	
p/1*						2x	
ARTICLE NO. 200 cm	1351.200	2350.100	1359.010	1359.020	1359.030	1359.015	2531.200
ARTICLE NO. 200 cm	4040.200						

All mounting material may be ordered separately. See overview on page 60.



wall hanging systems modern LED
ILLUME DUO RAIL

60
kg p/m

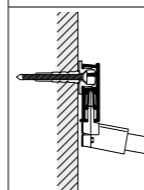
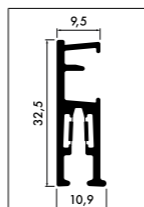

5
YEAR
WARRANTY

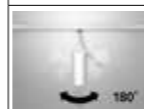

A minimalist rail system that combines hanging and lighting in one elegant line, safe, flexible, and fully integrated into the architecture of the space. Illume Duo Rail pairs Artiteq aesthetics with advanced 48V lighting technology. The result is a system that is not only functional, but also radiates the calm, balance, and precision that define high-end interior architecture. With a maximum load capacity of 60 kg per meter, the rail also provides the strength and security to effortlessly support even the most demanding art presentations.

The full range is available in two popular colors: matte black and fresh matte white. The rail, the luminaires, and the connectors are all supplied in these colors. For the modern, trend-conscious user, a Bronze (dark brown) luminaire is also available, an additional option for a modern, stylish interior.

RAIL



	Illume Duo Rail White	Illume Duo Rail Black
ARTICLE NO. 200 cm	45.11200	45.12200
ARTICLE NO. 300 cm	45.11300	45.12300

Includes fastener material and end caps.



compatible wires and hooks: pages 64–79



illume duo rail brochure

BEAMS

Beam 15' White 50 cm	Beam 15' Black 50 cm	Beam 15' Black / Bronze 50 cm	Beam 24' White 50 cm	Beam 24' Black 50 cm	Beam 24' Black / Bronze 50 cm	
ARTICLE NO.	45.21510	45.22510	45.23510	45.21500	45.22500	45.23500



ACCESSOIRES

Click & Connect	Endcap White	Endcap Black	Corner Connector White	Corner Connector Black	Screw 3,5 x 40 mm PVK P22 (incl. bit)	Plug 5 mm Fischer Duopower 5 x 25 mm	
ARTICLE NO.	45.31600	45.31400	45.31410	45.31420	45.31430	9.4945	9.4934

ACCESSOIRES

48V Connector Straight White	48V Connector Straight Black	48V Corner Connector Flex Set White	48V Corner Connector Flex Set Black	48V Driver Casambi 160VA	Wireless Switch Casambi	Screwdriver Allen key 1.5 mm	Screwdriver Flathead 4.0 mm	
ARTICLE NO.	45.31300	45.31310	45.31320	45.31330	45.32120	45.33100	45.95010	45.95020

ACCESSOIRES

48V Live-end White (down)	48V Live-end Black (down)	48V Live-end White (side)	48V Live-end Black (side)	48V Live-end White (up)	48V Live-end Black (up)	
ARTICLE NO.	45.31500	45.31510	45.31520	45.31530	45.31540	45.31550

wall hanging systems traditional
CLASSIC RAIL

20
kg p/m

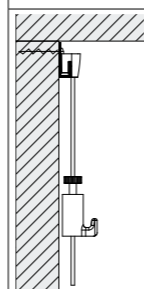
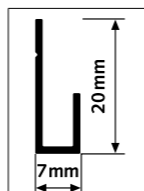

10
YEAR
WARRANTY



4 screws / m

Change pictures quickly and easily with Classic Rail

The Classic Rail is a wall rail that is often used in galleries and at exhibitions. This hanging system has an open J-shape which, with the aid of rods and sliding springs, makes it easy to hang pictures and other wall decorations. If you are looking for a discreet alternative to a rod, it is possible to use a cylinder hook with a transparent perlon cord in the rail. Depending on the weight of the picture or wall decoration, various hooks may be slid onto the perlon hanging wire.

A hanging rail for a contemporary interior

The Classic Rail is a J-shaped, open rail system with a modern look. This picture hanging system is available in white, aluminum and black. The rods that may be placed in the rail vary in thickness from 2 to 3 mm, and have a maximum load capacity of 20 kg. Available in white or steel, the rods use various sliding springs.

RAIL



	Classic Rail - White RAL 9010		Classic Rail - White Primer RAL 9016		Classic Rail - Alu		Classic Rail - Black Anodised	
	P/1*	P/20*	P/1*	P/20*	P/1*	P/20*	P/1*	P/20*
ARTICLE NO. 200 cm	9.4307	9.4357	-	9.4390	9.4305	-	9.4384	-
ARTICLE NO. 300 cm	9.4308	9.4358	-	-	9.4306	-	-	-
	Fastener Kit White		Fastener Kit White		Fastener Kit Grey		Fastener Kit Black	
ARTICLE NO. 200 cm	4072		4072		4071		5097	
ARTICLE NO. 300 cm	4079		4079		4078		-	

All mounting material may be ordered separately. See overview on page 60.



installation
video

CONTENT FASTENER KIT

		Quantity 200 cm	Quantity 300 cm
9.4941 (White) /9.4942 (Grey) /9.4943 (Black)	Screw	8x	12x
9.4934	Plug	8x	12x
2389	Instruction	1x	1x

All mounting material may be ordered separately. See overview on page 60.
* P/t: packaged by the piece in foil

RODS

	Rod White Steel U-Top 2 mm max. 20 kg	Rod White Steel U-Top 3 mm max. 20 kg	Rod Steel U-Top 3 mm max. 20 kg
ARTICLE NO. 100 cm	9.4216*	9.4161	9.4151
ARTICLE NO. 150 cm	-	9.4162	9.4152
ARTICLE NO. 200 cm	9.4217*	9.4163	9.4153
ARTICLE NO. 300 cm	-	9.4165	9.4155

*Compatible with hooks 9.4207, 9.4261, 3041200/50 - See page 70.

SLIDING SPRINGS

	Sliding Spring Stainless Steel 3 mm max. 20 kg
	9.4170

CYLINDER HOOKS

	Cylinder Hook White max. 15 kg	Cylinder Hook Alu max. 15 kg	Cylinder Hook Black max. 15 kg
	9.4237	9.4244	9.4240

For use with hanging wire Slider Economy 2 mm.

WIRES

	Slider Economy 2 mm max. 15 kg
ARTICLE NO. 100 CM	9.4424
ARTICLE NO. 150 CM	9.4425
ARTICLE NO. 200 CM	9.4426
ARTICLE NO. 250 CM	9.4427
ARTICLE NO. 300 CM	9.4428



Micro Grip 2 mm
30.41200 | 20 kg



Micro Grip Lock 2 mm
30.41250 | 20 kg

For more Picture Hooks see page 70.

wall hanging systems traditional
CLASSIC RAIL+

40
kg p/m



The Classic Rail+ is a picture hanging system for walls that has been specially developed for hanging heavier pictures and wall decorations (up to 40 kg). This hanging system is often used in galleries, at exhibitions and in museums. The hanging rail has an open, J-shaped design that makes it possible to hang a variety of rods equipped with rod hooks. This makes it extremely easy to hang or change art on the wall. The Classic Rail + is available in white, aluminum and black versions. A variety of aluminium or steel rods may be used for decorations weighing up to a maximum of 40 kg.

Secure picture hanging system

The Classic Rail+ makes it possible to hang pictures and wall decorations in a secure manner in rooms where this is required. Thanks to a blocking device, the rod is blocked in the rail and the picture enjoys extra protection when special anti-theft hooks are used on the rod itself.

RAIL

			
	Classic Rail+ - White RAL 9010	Classic Rail+ - Alu Anodised	Classic Rail+ - Black Anodised
	P/1*	P/1*	P/1*
ARTICLE NO. 200 cm	9.4318	9.4320	9.4315
ARTICLE NO. 300 cm	9.4319	9.4321	-
	Fastener Kit White	Fastener Kit Grey	Fastener Kit Black
ARTICLE NO. 200 cm	4072	4071	5097
ARTICLE NO. 300 cm	4079	4078	-

All mounting material may be ordered separately. See overview on page 60.



installation video

CONTENT FASTENER KIT

		Quantity 200 cm	Quantity 300 cm
	9.4941 (White) / 9.4942 (Grey) / 9.4943 (Black)	Screw	8x / 12x
	9.4934	Plug	8x / 12x
	2389	Instruction	1x / 1x

All mounting material may be ordered separately. See overview on page 60.
* P/1: packaged by the piece in foil

RODS 4 x 4 mm ALUMINIUM

			
	Rod Aluminium S-Bend White	Rod Aluminium S-Bend Alu	Stang Aluminium S-Bend Black
	max. 20 kg	max. 20 kg	max. 20 kg
ARTICLE NO. 100 cm	9.4277	9.4271	-
ARTICLE NO. 150 cm	9.4278	9.4272	-
ARTICLE NO. 200 cm	9.4279	9.4273	9.4276
ARTICLE NO. 250 cm	9.4280	9.4274	-

HOOKS

	
	Clamping Hook 20 kg
	4 x 4 mm
ARTICLE NO.	9.4253
	Compatible only with 4 x 4 mm aluminium rods



ROD 4 x 4 mm STEEL

	
	Rod U-Top Steel White
	max. 40 kg
ARTICLE NO. 100 cm	9.4220
ARTICLE NO. 150 cm	9.4221

HOOKS

	
	Clamping Hook 40 kg
	4 x 4 mm
ARTICLE NO.	9.4297
	Compatible only with 4 x 4 mm Steel Rods

ANTI-THEFT DEVICES*

			
	Blocking Device White	Clamping Hook Steel Anti-Theft 40 kg	Blocking Sleeve
	4 x 4 mm	4 x 4 mm	6 x 12 x 8 mm
ARTICLE NO.	9.4290	9.4291	9.4293
	Allen Key	Allen Key	
	2,5 mm	2,0 mm	
ARTICLE NO.	9.3390	9.3394	

*Only for use with rod u-top steel white 9.4220/9.4221/9.4222

wall hanging systems traditional
NEWLY R30 RAIL 

 **40**
 kg p/m



The Newly R30 Rail is a high-quality, professional wall rail specially designed for intensive use in galleries and museums.

A major advantage of the Newly R30 Rail is its versatility. Users can choose between: Elegant transparent hanging cords (perlon or steel), ideal for a refined appearance or a robust 4x4 mm aluminium rods, perfect for heavier works and added stability.

Thanks to this combination, the rail is suitable for both lightweight paintings and large, heavy artworks. The cords or rods can be attached anywhere along the rail, offering maximum flexibility when arranging or changing exhibitions.

The rail is made from high-grade aluminium, available in white, and has an impressive load capacity of 40 kg per meter.



RAIL



**Newly R30 Rail - White Primer
 RAL 9016**

P/1*

ARTICLE NO. 200 cm

1301.200

ARTICLE NO. 300 cm

1301.300

Fastener Kit White

ARTICLE NO. 200 cm

4040.230

All mounting material may be ordered separately. See overview on page 60.



installation
 video



compatible
 wires and hooks:
 pages 64-79

ROD



Newly Rod 2 mm Twister White

max. 5 kg

ARTICLE NO. 100 cm

9.4196

ARTICLE NO. 200 cm

9.4198

HOOK



**Newly Rod Hook H50
 5 kg**

ARTICLE NO.

3021.200

ROD



Newly S-Rod Alu White

max. 20 kg

ARTICLE NO. 200 cm

4110.200

HOOK



**Newly S-Rod Hook
 20 kg**

ARTICLE NO.

3030.100

All mounting material may be ordered separately. See overview on page 60.



wall hanging systems traditional
HEAVY DUTY TRACK 

 **200**
kg p/m



Crafted from durable steel, this rail can be mounted directly to the wall or discreetly built into it, offering maximum stability while allowing for a seamless look. The option to built in the rail makes it almost invisible, helping it blend perfectly with any interior design. The sliders, equipped with strong steel wire, can be effortlessly positioned anywhere along the rail and securely fastened, allowing for precise placement of each artwork.

What sets this system apart is its flexibility. The rail is available in white (RAL 9010) in a standard length of 200 cm. It can also be ordered in any desired colour and in custom lengths starting from 100 cm. This makes it easy to adapt the rail to the specific needs and style of any project.

RAIL



Heavy Duty Track Wall Rail - White RAL9010

Heavy Duty Track Wall Rail Special

200 cm

100 cm / Custom lengths from 100 cm available in any RAL colour

ARTICLE NO.

TS00004ST

TS00004SR

The rail comes pre-drilled with mounting holes, starting 10 cm from one end and repeating every 36 cm along its 200 cm length, and is supplied without installation materials. Consult with installer for most suitable installation material. All mounting material may be ordered separately. See overview on page 60.

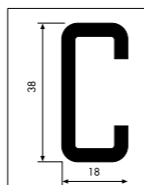

10
YEAR
WARRANTY

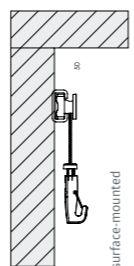

surface-mounted

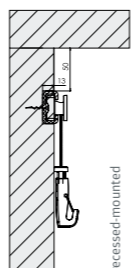

recessed-mounted



The Slider can be effortlessly positioned anywhere along the rail and securely fastened, allowing for precise placement of each artwork.

The Slider is compatible with both Slider 1.8 mm stainless steel wires and Twister 2.5 mm steel wire. Insert the wire through the Slider and fasten it on the rail.

The 1.8 mm stainless steel wires are available in lengths of 150 cm, 200 cm, 250 cm, 300 cm and 500 cm, while the 2.5 mm steel wires are offered in lengths of 200 cm, 300 cm and 500 cm.

SLIDER (for wall mounted track)



Slider

ARTICLE NO.

TS00005*

*Compatible with Slider Stainless Steel Wire 1.8 mm or Twister Steel Wire 2.5 mm

COMPATIBLE WIRES



1.8 mm

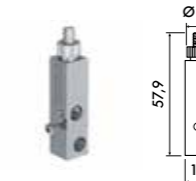

Track & Wire 1.2 -1.8 mm
TS30218
15-40 kg

Slider Stainless Steel Wire 1.8 mm

ARTICLE NO. 150 cm

TS75018Z15

ARTICLE NO. 200 cm

TS75018Z20

ARTICLE NO. 250 cm

TS75018Z25

ARTICLE NO. 300 cm

TS75018Z30

ARTICLE NO. 500 cm

TS75018Z50

COMPATIBLE WIRES



2.5 mm

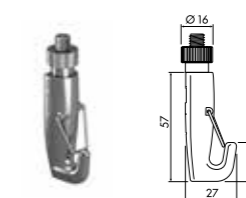

Auto Grip Lock 2.5 mm
6100.110
100 kg

Twister Steel Wire 2.5 mm

ARTICLE NO. 200 cm

TS75025T20

ARTICLE NO. 300 cm

TS75025T30

ARTICLE NO. 500 cm

TS75025T50

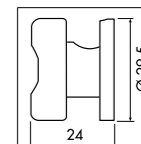

10
YEAR
WARRANTY

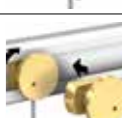

RAIL HANGING - TRACK & WIRE

for a secure hanging in combination with a picture hanging system

The Track & Wire was developed for suspending and securing paintings and objects on steel wires of 1.2 and 1.8 mm in combination with a picture hanging system. The Track & Wire is directly mounted on the back of the painting with the wire positioned in the right place within the rail.

Adjustability is achieved by means of an auto grip function within the Track & Wire, which holds the wire when tension is applied and allows movement when pressed. The screw on the side can be tightened for additional security. Providing a mechanical anti-theft solution. Two elements and wires are required per painting.

TRACK & WIRE

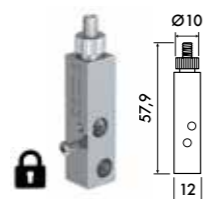

Track & Wire 1.2-1.8 mm / 15-40 kg

ARTICLE NO.

TS30218

*Used in combination with wires 1.2 and 1.8 mm. Two units are required per painting, frame or art object.

Installation instructions – Track & Wire

Step 1: Mount the Track & Wire onto the back of the painting or frame

Mount the Track & Wire directly on the back of the painting or frame. Position it higher to reduce tilting.

Step 2: insert the wire into the Track & Wire

Thread the 1.2 or 1.8 mm wire through the Track & Wire. It will automatically lock into place once you release it.

Step 3: Positioning the painting

Position the painting at the preferred height by adjusting the steel wire in the Track & Wire.

Step 4 & 5: Lock

Tighten the screw beneath and turn the screw on the top for additional security and a secure hanging.

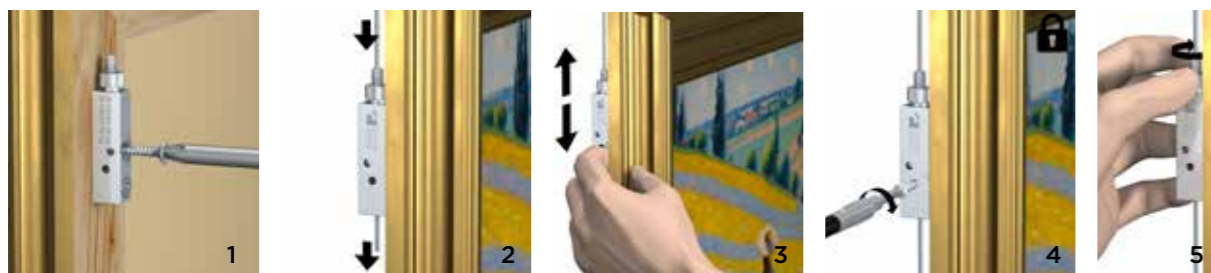

To ensure safe and professional hanging, it is essential to choose the correct combination of hook and steel wire based on the weight of the painting and the hanging system in use.

Track & Slide® offers steel wires in three different diameters:

1.2 mm wire: suitable for lighter objects

1.8 mm wire: medium-weight objects







2.5 mm wire: heavy-duty objects



The required diameter depends on the weight of the object to be hung. Always use two wires per object for optimal weight distribution and stability. The maximum weight load applies only when using Track & Slide® hooks in combination with our wires.

Each wire diameter is compatible with specific hooks, so selecting the correct wire also determines which hooks can be used.

Track & Slide® offers two Auto Grip Lock hooks and two accessories that are used in combination with a picture hanging rail system:

	 TS00218 15-40 kg	 TS30218 15-40 kg	 TS94620 15-40 kg	 6100.110 100 kg
	Auto Grip	Track & Wire 1.2 - 1.8 mm	Frame Hanger Junior M 1.2 - 1.8 mm	Auto Grip Lock 2.5 mm
	Lock			Lock
1.2 mm Steelwire 150 / 200 / 300 cm		<input checked="" type="checkbox"/>	<input checked="" type="checkbox"/>	<input checked="" type="checkbox"/>
1.8 mm Steelwire 150 / 200 / 300 cm		<input checked="" type="checkbox"/>	<input checked="" type="checkbox"/>	<input checked="" type="checkbox"/>
2.5 mm Steelwire 150 / 200 / 300 cm				<input checked="" type="checkbox"/>

PICTURE HANGING SYSTEMS

CEILING HANGING SYSTEMS

Top Rail	20 kg
Up Rail	20 kg
Newly R40 Rail	20 kg
Heavy Duty Track Ceiling	200 kg



- mounting next to recessed ceiling or ceiling
- rail disappears in ceiling
- preservation of walls

ceiling hanging systems
TOP RAIL

20
kg p/m

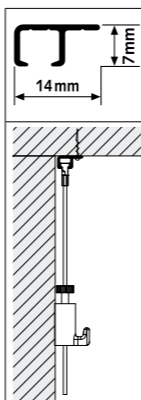

10
YEAR
WARRANTY



The flexible picture hanging system Top Rail is mounted to the ceiling. This ceiling rail that is discreet in its dimensions is an ideal hanging system to use in combination with recessed ceilings. By mounting the ceiling rail to the wooden side strip of a recessed ceiling, the rail 'disappears' into the ceiling. This 'invisible' picture hanging system then offers a flexible way to hang, change and replace pictures and wall decorations throughout the entire room.



RAIL



	Top Rail - White RAL 9003		Top Rail - Alu Anodised	Top Rail - Black Anodised	
	P/1*	P/10*	P/10*	P/1*	P/10*
ARTICLE NO. 200 cm	9.4309	9.4326	9.4313	9.4378	9.4323
ARTICLE NO. 300 cm	9.4310	9.4327	9.4314	9.4379	9.4324
		9.4362			9.4367
		Fastener Kit White		Fastener Kit Grey	
ARTICLE NO. 200 cm	4070		4069		4068
ARTICLE NO. 300 cm	4077		4076		4075

CONTENT FASTENER KIT



installation
video



		Quantity 200 cm	Quantity 300 cm
9.4912 (White) / 9.4913 (Alu) / 9.4903 (Black)	Screw	16x	24x
9.4900	Plug 4 mm	16x	24x
2390	Instruction	1x	1x

All mounting materials may be ordered separately. See page 60 - 8 screws / m
* P/1: packaged by the piece in foil / p/10 packaged per 10 in foil

ceiling hanging systems
UP RAIL

20
kg p/m

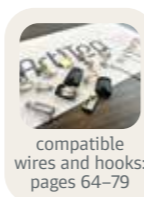
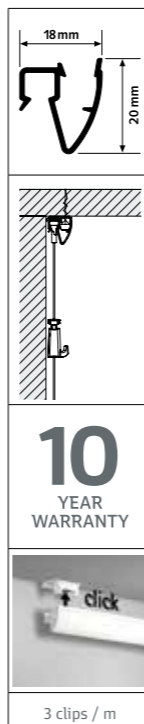

The Up Rail is the leading ceiling rail par excellence; the rail is especially suitable when used in combination with concrete. The picture hanging system is clicked into place using clips (3 clips each metre) which are attached to the ceiling. The beautiful rounded shape of the rail fills the space between the wall and ceiling, therefore the picture hanging system is discrete and unobtrusive. The maximum bearing capacity of 20 kg/m makes the Up Rail a solid and reliable hanging system. The rail has a white, primed finish: the hanging rail can be painted in any preferred colour (for example, in the colour of the wall or ceiling). The Twister hanging wires can be clicked anywhere along the rail. If a ceiling mounting is required, for example if the walls may not be damaged or because it is not possible to attach a rail to the walls, the Up Rail is the ideal solution for flexible adornment of the walls.

RAIL



	Up Rail - White Primer RAL 9016	Up Rail - Black Structure
ARTICLE NO. 200 cm	05.06200	05.06210
ARTICLE NO. 300 cm	05.06300	-
	Fastener Kit White	Fastener Kit Black
ARTICLE NO. 200 cm	4098	5096
ARTICLE NO. 300 cm	4099	-



CONTENT FASTENER KIT



installation
video



		Quantity 200 cm	Quantity 300 cm
05.06010	Click&Connect	6x	9x
9.4945	Screw	6x	9x
9.4934	Plug	6x	9x
05.06020 (White) / 05.06030 (Black)	Set End Cap L&R	2x	2x
2563	Instruction	1x	1x

All mounting material may be ordered separately. See overview on page 60.

ceiling hanging systems
NEWLY R40 RAIL 

 **20**
 kg p/m

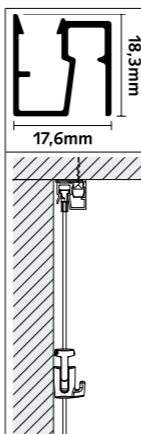

10
 YEAR
 WARRANTY



3 clips / m

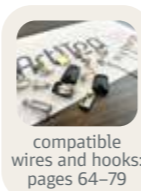

The Newly R40 Up Rail is a sleek, high-quality ceiling picture rail engineered for environments where wall drilling isn't ideal or possible. Whether you're outfitting a retail window, gallery space, exhibition area or contemporary interior, this ceiling-mounted system offers a flexible, discreet and reliable way to hang artwork, signage and decorative objects. The R40 has a weight capacity of 40 kg per metre.

Manufactured from premium aluminium, the R40 Up Rail mounts directly to the ceiling using clip-on fasteners, making installation simple and unobtrusive. Its compact profile integrates seamlessly with any interior. The rail comes in a white primer finish (RAL 9016) that can be easily painted to match ceiling colours or design schemes, ideal for achieving a tailored, architectural look.

RAIL



**Newly R40 Rail - White Primer
 RAL 9016**

P/1*

ARTICLE NO. 200 cm

1401.200

Fastener Kit White

ARTICLE NO. 200 cm

4044.200

All mounting material may be ordered separately.
 See overview on page 60.



ceiling hanging systems
HEAVY DUTY TRACK 

 **200**
kg p/m



This robust rail system is specifically designed for ceiling mounting, offering a discreet and refined solution for displaying art. Whether surface-mounted or recessed into the ceiling, it provides exceptional stability while maintaining a minimalist and streamlined appearance. When recessed, the rail virtually disappears, seamlessly complementing any interior design.

The sliders with sturdy steel wires, can be easily adjusted along the length of the rail. This ensures not only flexibility but also precision in positioning.

Delivered as standard in white (RAL 9010) and a length of 200 cm, the rail is also available in any custom length starting from 100 cm, and can be powder-coated in any RAL colour. This allows the ceiling rail to fit perfectly into both residential and commercial spaces, tailored to the unique aesthetic and functional demands of each project.

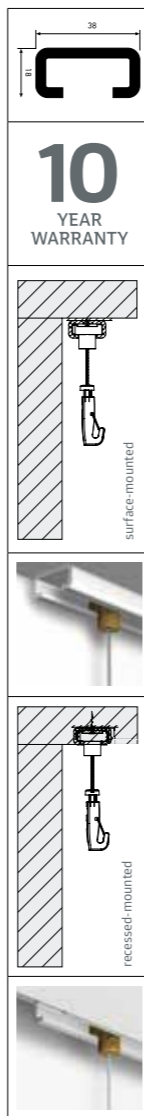

RAIL

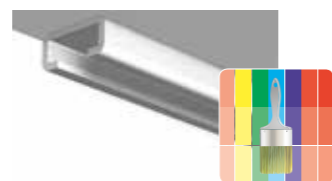
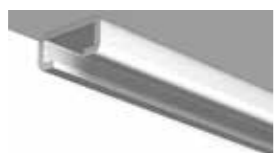

	Heavy Duty Track Ceiling Rail - White RAL9010	Heavy Duty Track Ceiling Rail Special
	200 cm	100 cm / Custom lengths from 100 cm available in any RAL colour
ARTICLE NO.	TS00004ST	TS00004SR

The rail comes pre-drilled with mounting holes, starting 10 cm from one end and repeating every 36 cm along its 200 cm length, and is supplied without installation materials. Consult with installer for most suitable installation material. All mounting material may be ordered separately. See overview on page 60.

The Slider can be effortlessly positioned anywhere along the rail and securely fastened, allowing for precise placement of each artwork.

The Slider is compatible with both Slider 1.8 mm stainless steel wires and Twister 2.5 mm steel wire. Insert the wire through the Slider and fasten it on the rail.

The 1.8 mm stainless steel wires are available in lengths of 150 cm, 200 cm, 250 cm, 300 cm and 500 cm, while the 2.5 mm steel wires are offered in lengths of 200 cm, 300 cm and 500 cm.

SLIDER (for ceiling mounted track)



Slider

ARTICLE NO.	TS00006*
--------------------	----------

*Compatible with Slider Stainless Steel Wire 1.8 mm or Twister Steel Wire 2.5 mm

COMPATIBLE WIRES



1.8 mm



Track & Wire 1.2 -1.8 mm
TS30218
 15-40 kg

Slider Stainless Steel Wire 1.8 mm

ARTICLE NO. 150 cm	TS75018Z15
ARTICLE NO. 200 cm	TS75018Z20
ARTICLE NO. 250 cm	TS75018Z25
ARTICLE NO. 300 cm	TS75018Z30
ARTICLE NO. 500 cm	TS75018Z50

COMPATIBLE WIRES



2.5 mm

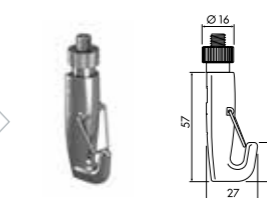

Auto Grip Lock 2.5 mm
6100.110
 100 kg

Twister Steel Wire 2.5 mm

ARTICLE NO. 200 cm	TS75025T20
ARTICLE NO. 300 cm	TS75025T30
ARTICLE NO. 500 cm	TS75025T50



PICTURE HANGING SYSTEMS

INTEGRATED HANGING SYSTEMS

Deco Rail	20 kg
Deco Rail LED	20 kg
Shadowline Drywall	20 kg
Shadowline Masonry	20 kg

- for building and renovation projects
- rail is installed with ceiling construction
- hanging wires hang directly from ceiling

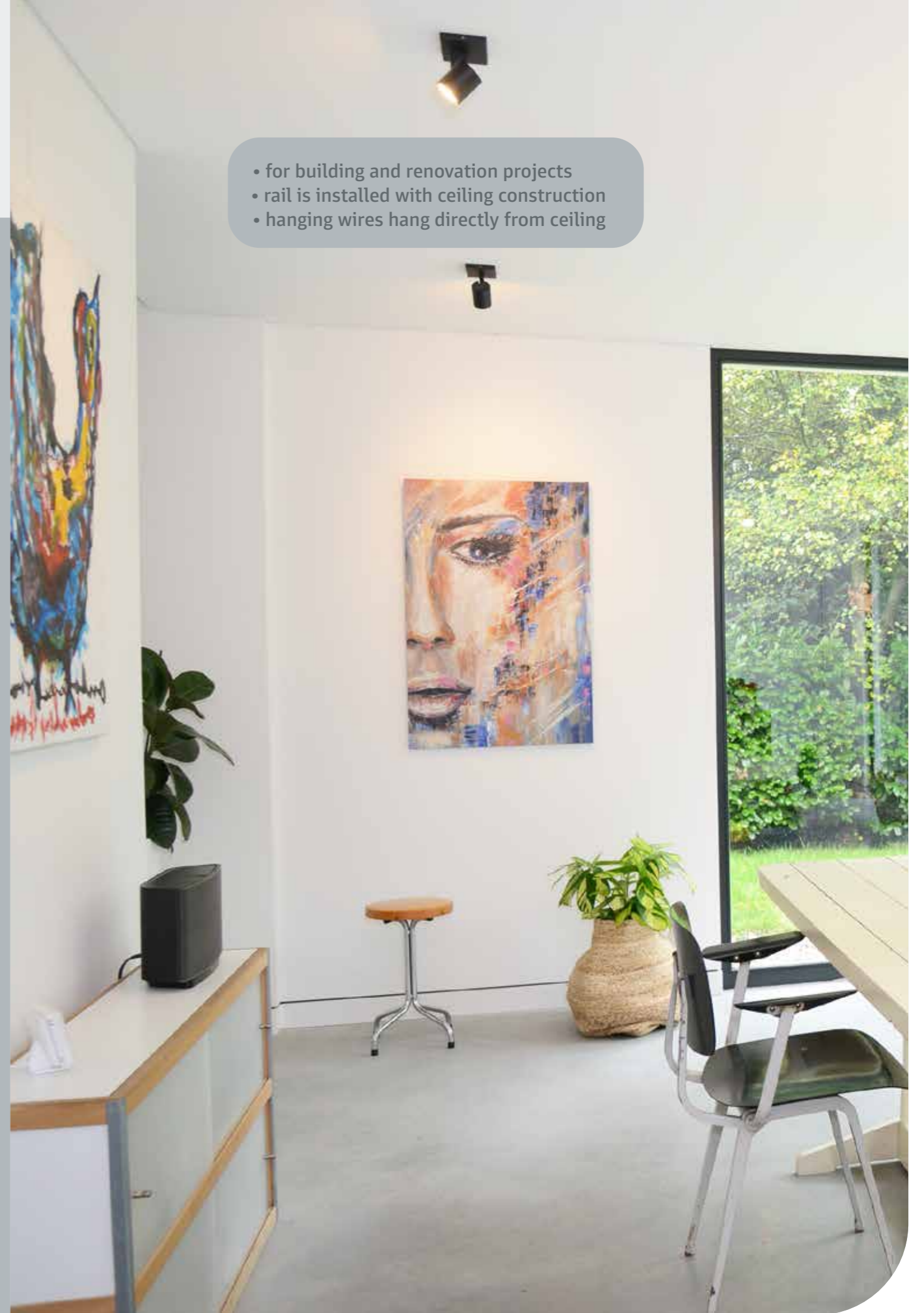

integrated hanging systems
DECO RAIL

 **20**
kg p/m

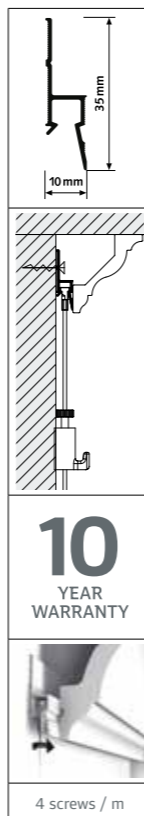

10
YEAR
WARRANTY

Flexible options for smooth walls with Deco Rail

The Deco Rail is a hanging rail for pictures and wall decorations that is mounted behind a cornice. The hanging system becomes invisible as a result, while still offering all the advantages of a flexible hanging system.

Walls with a clean, smooth finish remain undamaged, even though it is still possible to hang and move paintings continually. Hanging wires may be clicked into the rail behind the cornice at any desired location. This is the major benefit of the Deco Rail: flexibility and a guarantee for a high-quality finish. There are many different styles of cornice rails, and this hanging rail can be installed behind every type. The Deco Rail is available in combination with a selection of three different types of cornices: Basic, Modern and Classic.

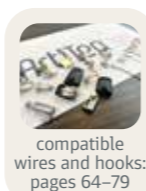

compatible wires and hooks: pages 64–79



installation video



RAIL / CORNICE MOULDINGS

				
	Deco Rail - White Primer RAL9016	CX 110 Basic	CX 126 Modern	C 213 T Classic
MOULDING DIMENSIONS		4 x 4,5 x 200 cm	9 x 9 x 200 cm	8 x 8 x 200 cm
ARTICLE NO. 200 cm	05.75100	05.75110	05.75126	05.75213

FASTENER MATERIAL

			
	270 ml	310 ml (for 7,8 m)	8x
	Ultra FX400	FDP500 Glue	Fastener Kit
	for connecting joints	wall and ceiling	9.4945 Fischer DuoPower 5x25 5 mm 8x 9.4934 screw 3,5 x 40 mm
ARTICLE NO.	1014	1016	4088

integrated hanging systems
DECO RAIL LED

 **20**
kg p/m

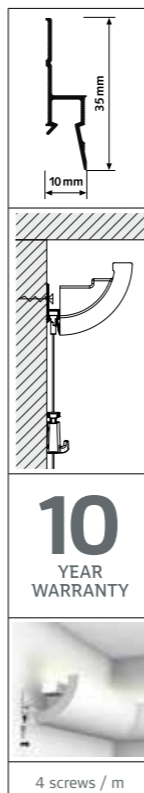

10
YEAR
WARRANTY

Invisible hanging system with subtle indirect lighting

The Deco Rail LED is a hanging system and lighting profile, with subtle indirect LED lighting in one. With the lighting profile C362 by ORAC, you add indirect lighting by diffusing light from the wall. A modern, ambient finish within the interior. Combining the Deco Rail with the lighting profile results in an invisible hanging system and allows flexible adornment of the walls. With no damage to sleekly finished walls, pictures can be hung and moved around whenever you please. Hanging wires can be clicked anywhere along the rail behind the lighting profile. The indirect lighting profile is supplied without the LED.



installation
video



compatible
wires and hooks:
pages 64–79

RAIL / LIGHTING PROFILE



Deco Rail LED - White Primer
RAL9016



C362 Lighting Profile

PROFILE DIMENSIONS

5 x 5 x 200 cm

ARTICLE NO. 200 cm

05.75100

05.75362



FASTENER MATERIAL



290 ml (voor 7-8 m)

FDP700 Decofix Power 290 ml

glue for Deco Rail LED

1017

8X



Fastener Kit

9.4945 Fischer Duopower 5x25 5 mm

8x 9.4934 screw 3,5 x 40 mm

4088

ARTICLE NO.

integrated hanging systems
SHADOWLINE DRYWALL

20
 kg p/m

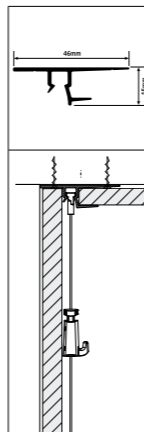

10
 YEAR
 WARRANTY

compatible
 wires and hooks:
 pages 64-79

Hanging rail for plasterboard ceilings and walls (drywall)

The Shadowline rail - drywall enables the placement of an invisible picture hanging system between plasterboard walls and ceiling panels. A discreet shadow line is the only element that appears between the wall and ceiling, and this is where the flexible picture hanging system is hidden. It is possible to install a hanging cord in the rail, anywhere you like in the room. Since the rail itself isn't visible, the hanging cords are suspended directly from the ceiling. If you choose the transparent perlon hanging cords for the rail, you will have the most discreet picture hanging system at your disposal. Using the Shadowline ceiling system means you will always have a guarantee of smooth, clean walls, and the flexibility to decorate them any way you like, without the need for tools.

RAIL



Shadowline Drywall - White Primer
 RAL9016

ARTICLE NO. 200 cm for use with drywall 13 mm

05.08440

Fastener Kit

ARTICLE NO. 200 cm

4088



installation
 video

CONTENT FASTENER KIT

9.4945	Screw	8x
9.4934	Plug	8x

The rail is not pre drilled

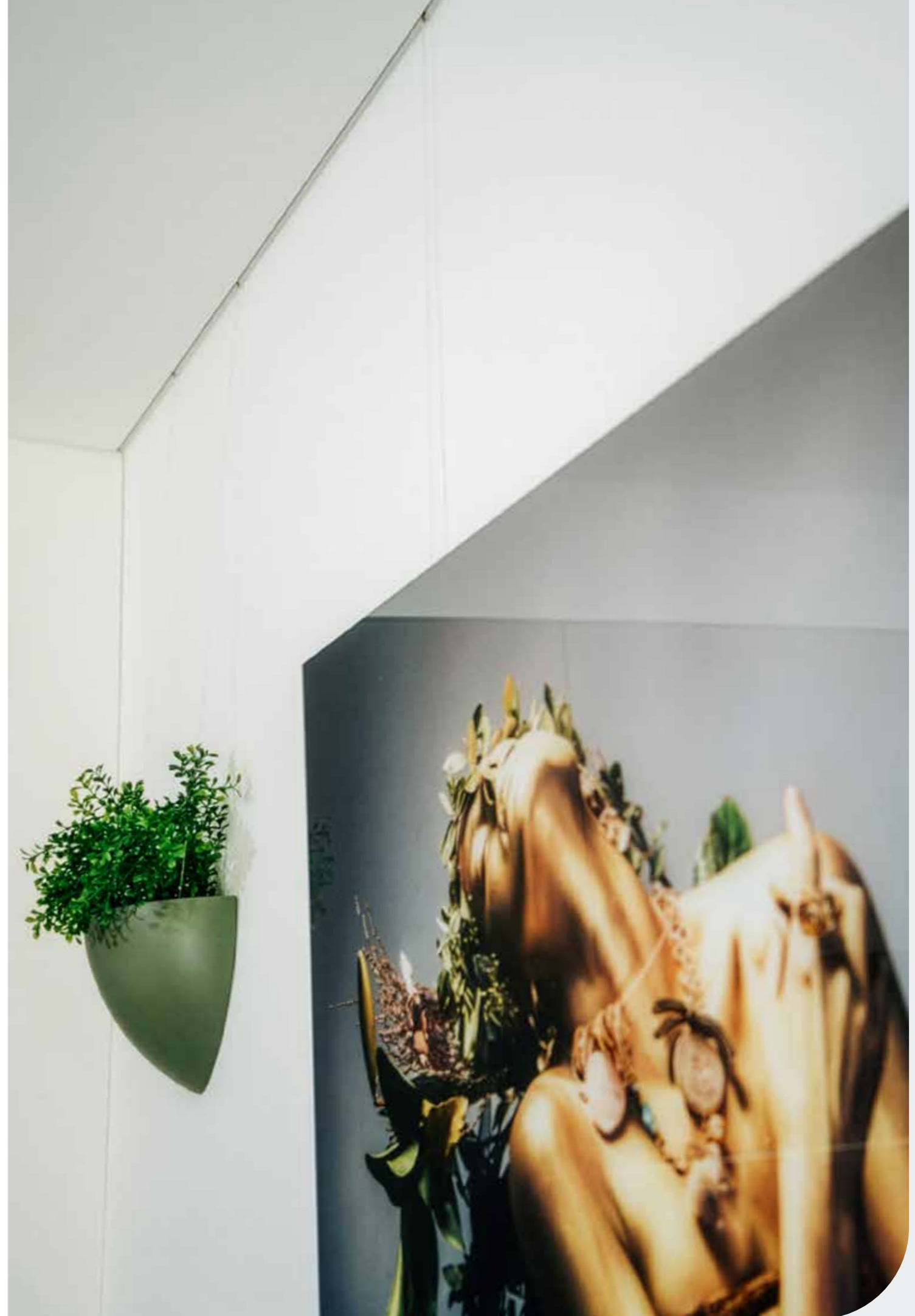

integrated hanging systems
SHADOWLINE MASONRY

20
 kg p/m

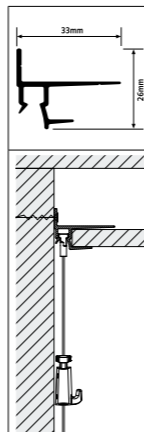

10
 YEAR
 WARRANTY



7 screws / 2,5 m

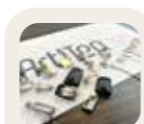

compatible
 wires and hooks:
 pages 64-79

Hanging rail for plasterboard ceilings and masonry walls

The Shadowline rail - masonry offers the same advantages as the plasterboard version, yet has been specially designed for use with masonry walls. The Shadowline rail is installed on a masonry wall during the building or renovation phase. The Shadowline profile disappears completely in the shadow line next to the ceiling panels, yet still offers all the advantages of a flexible hanging system: undamaged, clean walls and the flexibility to quickly and easily hang paintings and other wall decorations and move them around as desired.

RAIL



Shadowline Masonry - White Primer
 RAL9016

ARTICLE NO. 200 cm for use with brickwall 13 mm

05.08450

Fastener Kit

ARTICLE NO. 200 cm

4088



installation
 video

CONTENT FASTENER KIT

9.4945	Screw	8x
9.4934	Plug	8x

The rail is not pre drilled



FASTENER MATERIAL

picture hanging systems - wall / ceiling / integrated



all installation videos

	Click&Connect 3 clips/m	Click&Connect 3 Rings 3 clips/m	Fastening Clip Round 3 clips/m	Click&Connect 3 clips/m	Click&Connect 3 clips/m	Click&Connect 3 clips/m	Click & Connect	Adjust Plate	Clip White	Clip White
+ advised o possible	9.4113	9.4119	9.4106	9.4124	30.31110	05.06010	45.31600	6100.010	3010.101*	3010.400*
CONTOUR RAIL P. 12					+					
CLICK RAIL P. 18	+	+	+							
CLICK RAIL PRO P. 20				+						
UP RAIL P. 44						+				
NEWLY R10 RAIL P. 16									+	
NEWLY R20 RAIL P. 17									+	
NEWLY R30 RAIL P. 38									+	
NEWLY R35 RAIL LED P. 26									+	
ILLUME DUO RAIL P. 28							+			
NEWLY R40 RAIL P. 46										+
NEWLY R70 RAIL P. 24								+		

*Use 3 pieces per meter

	End Cap White	End Cap White	End Cap Grey	End Cap Black	End Cap White	End Cap Grey	End Cap White	End Cap Black
	30.31210	9.4105	9.4104	9.4112	9.4120	9.4121	2101.100	2103.100
CONTOUR RAIL	+							
CLICK RAIL		+	+	+				
CLICK RAIL PRO					+	+		
NEWLY R10 RAIL							+	+
NEWLY R20 RAIL								+
NEWLY R30 RAIL								
NEWLY R40 RAIL								
NEWLY R70 RAIL								

	End Cap White	Corner Connector White	End Cap Grey	End Cap White	End Cap White	End Cap White
	2201.100	2202.100	2102.100	2301.100	6100.040	2401.100
			+			
	+	+	+			
				+		
						+
					+	

	Corner Connector White	Corner Connector Grey	Corner Connector Black	Corner Connector White	Corner Connector Silver	Corner Connector White	Corner Connector Silver	Corner Connector White
	9.4107	9.4108	9.4114	2101.200	2102.200	2201.200	2202.200	2301.200
CLICK RAIL	+	+	+					
CLICK RAIL PRO								
UP RAIL								
NEWLY R10 RAIL				+			+	
NEWLY R20 RAIL						+	+	
NEWLY R30 RAIL								+
NEWLY R35 RAIL LED								
ILLUME DUO RAIL								

*Use 3 pieces per meter

	Corner Connector White	Corner Connector Grey	Corner Connector White	Corner Connector Black	Set End Caps L&R White	Set End Caps L&R Black	Endcap White	Endcap Black	End Cap White + Wire Guide L+R
	9.4122	9.4123	45.31420	45.31430	05.06020	05.06030	45.31400	45.31410	2351.200
	+	+			+	+			
									+
			+	+			+	+	



FASTENER MATERIAL

picture hanging systems - wall / ceiling / integrated



all installation videos

	Screws					Fischer Duopower		Screws			Drill Template
	Fischer Duopower 5x25 5 mm	Screw 3,5 mm x 40 mm White	Screw 3,5 mm x 40 mm Alu	Screw 3,5 mm x 40 mm Black	Screw 3,5 mm x 40 mm	Fischer Duopower 5x25 8 mm	Stainless Steel Din 571 6x80	Plug 4 mm	Screw 9.4912 (White) / 9.4913 (Alu) / 9.4903 (Black)	Screw Metal Stud 3,5 mm x 38 mm (For use with metal) (No plug)	
+ advised o possible	9.4934	9.4941	9.4942	9.4943	9.4945	6100.030*	6100.020*	9.4900	9.4912/13/03	9.4928	4090.100
CONTOUR RAIL	+				+					+	
CLICK RAIL	+				+					+	
CLICK RAIL PRO	+				+					+	
CLASSIC RAIL	+	+	+	+	+						
CLASSIC RAIL+	+	+	+	+	+						
UP RAIL	+				+					+	
TOP RAIL								+	+		
DECO RAIL	+				+					+	
SHADOWLINE MASONRY / DRYWALL	+				+						
NEWLY R10 RAIL	+				+						+
NEWLY R20 RAIL	+				+						+
NEWLY R30 RAIL	+				+						+
NEWLY R35 RAIL LED	+				+						
ILLUME DUO RAIL	+				+						
NEWLY R40 RAIL	+				+						
NEWLY R70 RAIL						+	+				

Classic Rail, Classic Rail+ and Deco Rail: 1 screw per 250 mm, Shadowline Masonry: 1 screw per 300 mm, Top rail: 1 screw per 125 mm

FASTENER KITS



	White		White Primer		Alu		Black	
	200 cm	300 cm	200 cm	300 cm	200 cm	300 cm	200 cm	300 cm
CONTOUR RAIL			30.31310	30.31330				
CLICK RAIL	4065	4061	4065	4061	4064	4060	5094	5095
CLICK RAIL PRO			4067	4074	4066	4073		
CLASSIC RAIL	4072	4079	4072	4079	4071	4078	5097	
CLASSIC RAIL +	4072	4079			4071	4078	5097	
UP RAIL			4098	4099			5096	
TOP RAIL	4070	4077	4070	4077	4069	4076	4068	4075
DECO RAIL	4088							
DECO RAIL LED	4088							
SHADOWLINE DRYWALL	4088							
SHADOWLINE MASONRY	4088							
NEWLY R10 RAIL	4040.210 *				4040.211 *		4040.212 *	
NEWLY R20 RAIL	4040.220 *				4040.221 *			
NEWLY R30 RAIL	4040.230 *							
NEWLY R40 RAIL	4044.200							
NEWLY R70 RAIL	6100.050							

* Fastener kit contains clips, screws, plugs, end caps, corner connector and one drill template



PICTURE HANGING SYSTEMS

HANGING WIRES & HOOKS

- Wide range of hooks
- 4 kg to 20 kg load capacity
- Invisible Perlon hanging wires
- Robust steel hanging wires
- Perlon hanging wires of 1 mm and 2 mm
- Steel wire hanging wires of 1 mm and 2 mm
- Black steel hanging wire 1 mm

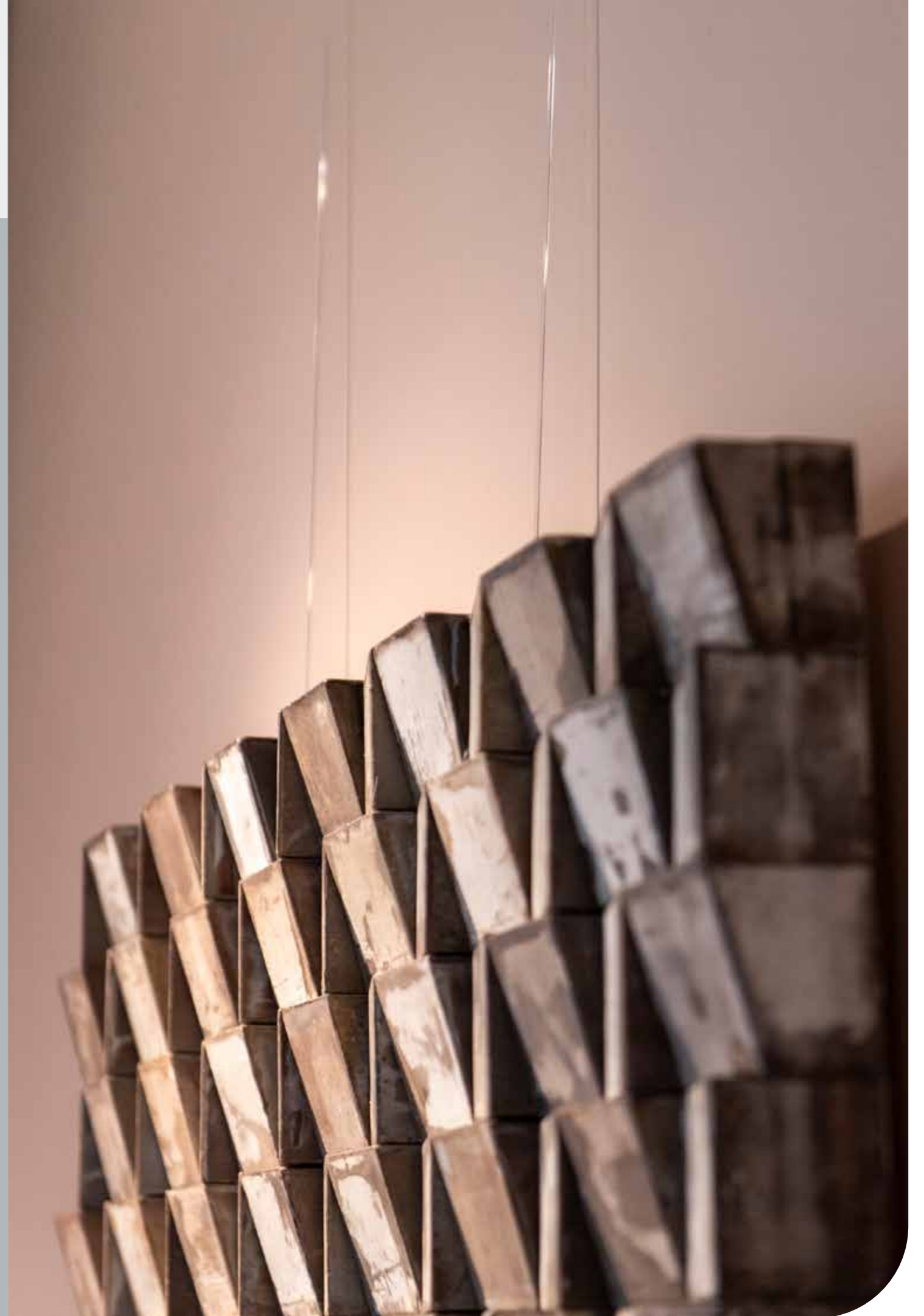

hanging wires and hooks
HANGING WIRES

In addition to the different hanging systems that Artiteq offers, there are (small) essential parts that are needed to actually hang the painting or wall decoration you want on the chosen rail. For example, there are various types of hanging wires and hooks to choose from, depending on your chosen rail and the weight of your painting or wall decoration.



TWISTER™



1 SIMPLE-SAFE-STRONG

Artiteq developed the Twister glider system for all its hanging rails. Twister offers the most Logical and user-friendly way to hook the hanging wire into the rail: insert, twist, click and you're done. Since the Twister may be clicked anywhere on the rail, you can hang a picture anywhere you like on the wall. You have the option of using Twister in perlon, steel wire or rods for all the Artiteq hanging systems. The perlon and steel hanging wires with the Twister mechanism are available in 1 or 2 mm thicknesses, and in lengths ranging from 100 to 500 cm.



installation video

TWISTER™

Twister is a European Registered Community Design.

TWISTER™ CLIQ2FIX_{perlon}



2

EXTRA EASE-OF-USE

Thanks to the development of the Twister Cliq2Fix perlon system, perlon cord now has an additional functionality when it comes to hanging pictures. The hanging wire equipped with the Twister Cliq2Fix system may be inserted in the rail, eliminating the risk of the perlon cord popping loose from the rail as a result of its recoiling effect. This makes it extra safe, and easy to slide into the rail. In other words, extra ease-of-use.



installation video



SOLID SLIDER

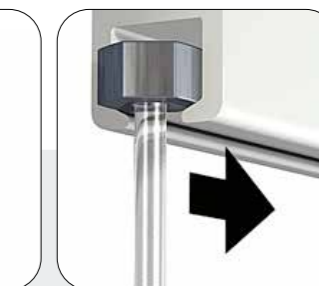
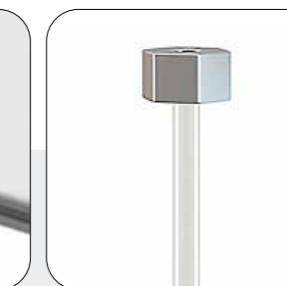
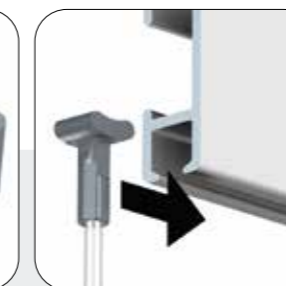

3

SLIDE INTO SIDE

Artiteq developed the Solid Slider system which attaches the hanging wire with glider via the side of the rail. This system is available for 2 mm perlon and 2 mm steel wire. The hanging wire may be freely slid into the hanging rail, yet may not be removed from the rail as easily. Hanging wires with the Solid Slider mechanism are available in lengths of 100, 150, 200, 250, 300 en 500 cm. A slanted stop system is available for slanted walls. This system makes it possible to use a flexible picture hanging system even with slanted walls, for example in a staircase.



installation video

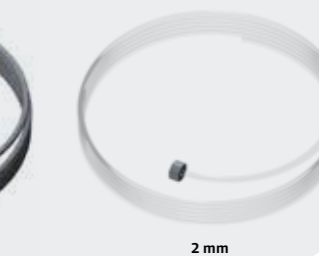

hanging wires and hooks
HANGING WIRES



1 mm vs 2 mm hanging wires

Artiteq offers the Twister hanging wires in two different thicknesses; 1 mm and 2 mm. Both perlon and steel wire hanging wires are available in the two different thicknesses. The steel wire black hanging wires are only available in 1 mm.

The choice of choosing 1 mm hanging wires depends on one's own requirements. The smaller the diameter of the hanging wire, the less visible it is. Especially with the perlon hanging wires, the choice for 1 mm can be preferable. To hang a frame or wall decoration as invisible as possible.



1 mm

2 mm



1 mm

2 mm

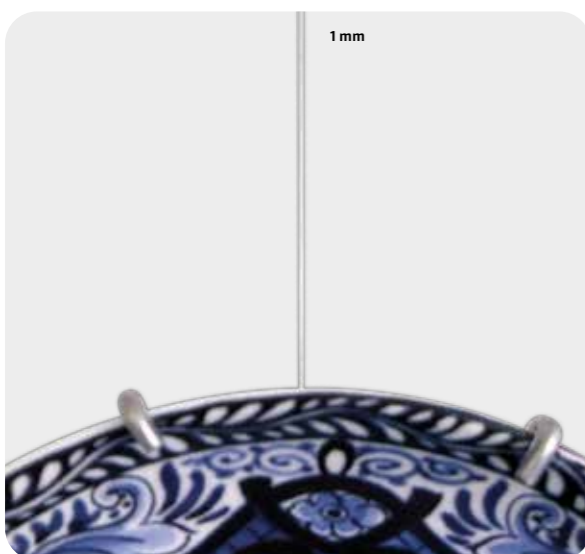

1 mm



2 mm

1 mm

Twister 1 mm



30.21150	Twister	1 mm	Perlon	5 kg	150 cm
30.21200	Twister	1 mm	Perlon	5 kg	200 cm
30.21300	Twister	1 mm	Perlon	5 kg	300 cm
30.22150	Twister	1 mm	Steel	10 kg	150 cm
30.22200	Twister	1 mm	Steel	10 kg	200 cm
30.22300	Twister	1 mm	Steel	10 kg	300 cm
09.63150	Twister	1 mm	Steel Black	10 kg	150 cm
09.63200	Twister	1 mm	Steel Black	10 kg	200 cm
09.63300	Twister	1 mm	Steel Black	10 kg	300 cm

2 mm

Twister 2 mm



09.23100	Twister	2 mm	Perlon	20 kg	100 cm
09.23150	Twister	2 mm	Perlon	20 kg	150 cm
09.23200	Twister	2 mm	Perlon	20 kg	200 cm
09.23250	Twister	2 mm	Perlon	20 kg	250 cm
09.23300	Twister	2 mm	Perlon	20 kg	300 cm
09.23500	Twister	2 mm	Perlon	20 kg	500 cm
09.33100	Twister	2 mm	Steel	20 kg	100 cm
09.33150	Twister	2 mm	Steel	20 kg	150 cm
09.33200	Twister	2 mm	Steel	20 kg	200 cm
09.33250	Twister	2 mm	Steel	20 kg	250 cm
09.33300	Twister	2 mm	Steel	20 kg	300 cm
09.33500	Twister	2 mm	Steel	20 kg	500 cm

2 mm

Twister Rod 2 mm



9.4196	TWISTER	2 mm	Rod White	20 kg	100 cm
9.4198	TWISTER	2 mm	Rod White	20 kg	200 cm

2 mm

Twister Cliq2fix Perlon 2 mm



09.13100	Twister Cliq2Fix	2 mm	Perlon	20 kg	100 cm
09.13150	Twister Cliq2Fix	2 mm	Perlon	20 kg	150 cm
09.13200	Twister Cliq2Fix	2 mm	Perlon	20 kg	200 cm
09.13250	Twister Cliq2Fix	2 mm	Perlon	20 kg	250 cm
09.13300	Twister Cliq2Fix	2 mm	Perlon	20 kg	300 cm

2 mm

Solid Slider 2 mm



08.23100	Solid Slider	2 mm	Perlon	20 kg	100 cm
08.23150	Solid Slider	2 mm	Perlon	20 kg	150 cm
08.23200	Solid Slider	2 mm	Perlon	20 kg	200 cm
08.23250	Solid Slider	2 mm	Perlon	20 kg	250 cm
08.23300	Solid Slider	2 mm	Perlon	20 kg	300 cm
08.23500	Solid Slider	2 mm	Perlon	20 kg	500 cm
08.43100	Solid Slider	2 mm	Steel	20 kg	100 cm
08.43150	Solid Slider	2 mm	Steel	20 kg	150 cm
08.43200	Solid Slider	2 mm	Steel	20 kg	200 cm
08.43250	Solid Slider	2 mm	Steel	20 kg	250 cm
08.43300	Solid Slider	2 mm	Steel	20 kg	300 cm
08.43500	Solid Slider	2 mm	Steel	20 kg	500 cm

2 mm

Slider Economy 2 m



















9.4424	Slider Economy	2 mm	Perlon	15 kg	100 cm
9.4425	Slider Economy	2 mm	Perlon	15 kg	150 cm
9.4426	Slider Economy	2 mm	Perlon	15 kg	200 cm
9.4427	Slider Economy	2 mm	Perlon	15 kg	250 cm
9.4428	Slider Economy	2 mm	Perlon	15 kg	300 cm

All these hanging wires are compatible with the hooks on page 70 & 71.

hanging wires and hooks
HOOKS & COMPATIBILITY

Depending on the weight of a frame or other wall decoration, the right picture hook must be selected. The wide product range offers hooks with maximum load capacities varying from 4 kg to 20 kg.

							
	30.41200 20 kg	30.41250 20 kg	3020.100 20 kg	3020.200 Security 20 kg	9.4264 15 kg	9.4261 15 kg	30.41100 10/5 kg
	Auto Grip	Auto Grip	Auto Grip	Auto Grip	Auto Grip	Auto Grip	Auto Grip
	Lock			Lock	Lock		
 Twister 1 mm Perlon 150 / 200 / 300 cm							✓
 Twister 1 mm Steelwire 150 / 200 / 300 cm							✓
 Twister 1 mm Steelwire Black 150 / 200 / 300 cm							✓
 Twister 2 mm Perlon 100 / 150 / 200 250 / 300 / 500 cm	✓	✓	✓	✓	✓	✓	
 Twister 2 mm Steelwire 100 / 150 / 200 250 / 300 / 500 cm	✓	✓	✓	✓	✓	✓	
 Twister 2 mm Rod White 100 / 200 cm	✓	✓	✓	✓		✓	
 Twister Clig2Fix 2 mm Perlon 100 / 150 / 200 250 / 300 cm	✓	✓	✓	✓	✓	✓	
 Solid Slider 2 mm Perlon* 100 / 150 / 200 250 / 300 / 500 cm insert from the side	✓	✓	✓	✓	✓	✓	
 Solid Slider 2 mm Steelwire* 100 / 150 / 200 250 / 300 / 500 cm insert from the side	✓	✓	✓	✓	✓	✓	

									
	9.4208 10 kg	9.4219 7 kg	9.4209 7 kg	9.4207 5 kg	3021.100 5 kg	3021.200 5 kg	9.4205 4 kg	3024.100 4 kg	3023.100 3 kg
	Manual	Manual	Manual	Manual	Manual	Manual	Manual	Manual	Manual
 Twister 2 mm Perlon 100 / 150 / 200 250 / 300 / 500 cm	✓	✓	✓	✓	✓		✓	✓	✓
 Twister 2 mm Rod White 100 / 200 cm				✓		✓			
 Twister Clig2Fix 2 mm Perlon 100 / 150 / 200 250 / 300 cm	✓	✓	✓	✓	✓		✓	✓	✓
 Solid Slider 2 mm Perlon* 100 / 150 / 200 250 / 300 / 500 cm insert from the side	✓	✓	✓	✓	✓		✓	✓	✓

hanging wires and hooks

HOOKS

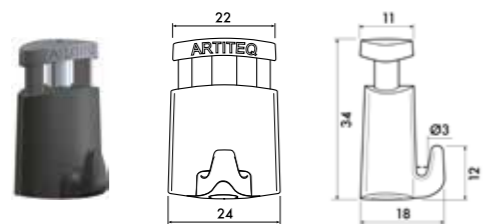

Auto Grip 20 kg

ARTICLE NO. 30.41200

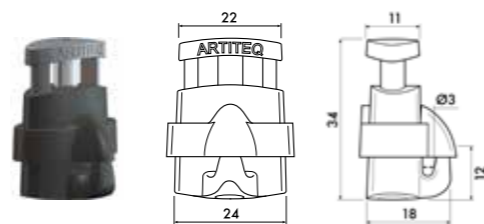

Auto Grip 20 kg

30.41250

Lock

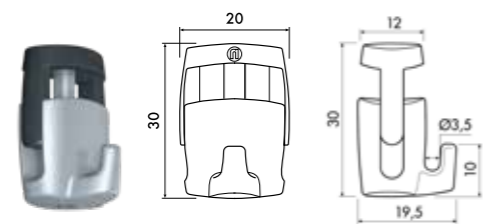

Auto Grip 20 kg

ARTICLE NO. 3020.100

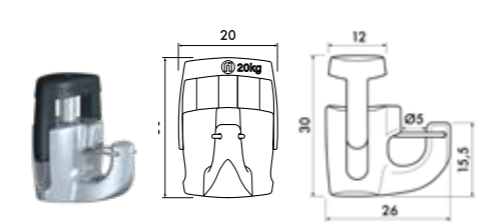

Auto Grip Security 20 kg

3020.200

Lock

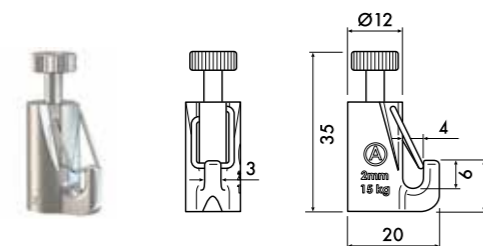

Auto Grip 15 kg

ARTICLE NO. 9.4264

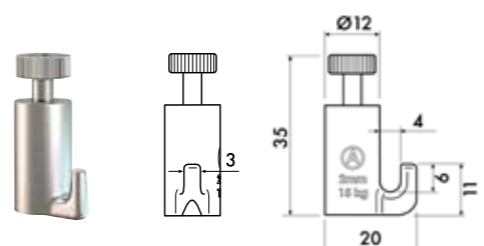

Auto Grip 15 kg

9.4261

Lock

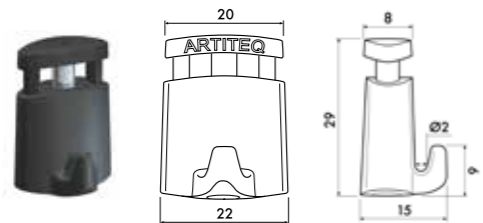

Auto Grip 5/10 kg

ARTICLE NO. 30.41100

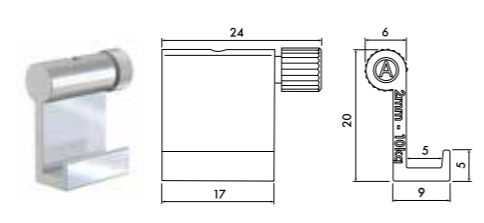

Auto Grip 10 kg

9.4208

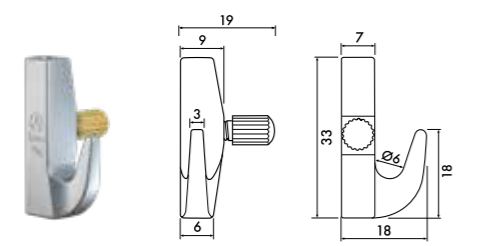

Manual 7 kg

ARTICLE NO. 9.4219

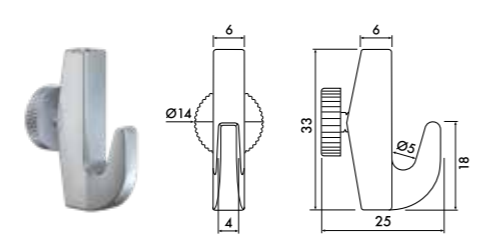

Manual 7 kg

9.4209

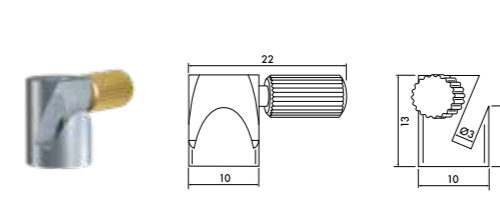

Manual 5 kg

ARTICLE NO. 9.4207

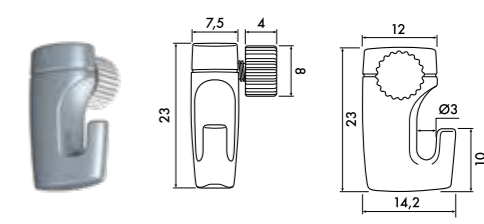

Manual 5 kg

3021.100

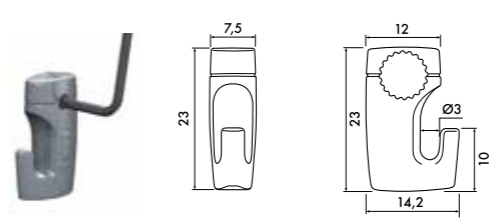

Manual 5 kg

ARTICLE NO. 3021.200

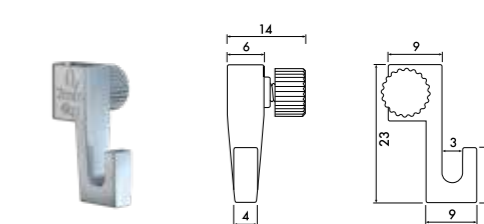

Manual 4 kg

9.4205

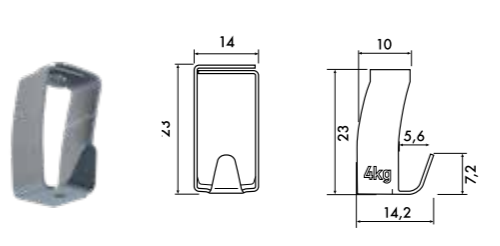

Manual 4 kg

ARTICLE NO. 3024.100

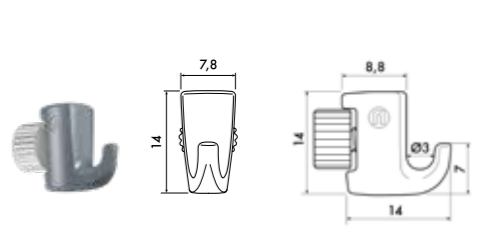

Manual 3 kg

3023.100



hanging wires and hooks COMBINATIONS

A picture hanging system comprises the following elements: **rail**, **hanging wire** and **hanging hook**. Artiteq guarantees the functionality of the products because it carefully coordinates the various elements of a picture hanging system. The quality can only be guaranteed when original (Artiteq) products are combined correctly. The guarantee is null and void if there are combinations other than with the correct Artiteq products. A frame or canvas will always hang more steadily if **2 hanging wires** are used.

The weight of the frame determines the choice of the hook and wire, in combination with the maximum weight carrying capacity of one metre of the rail.

INCORRECT COMBINATIONS

CORRECT COMBINATIONS

hanging wires and hooks HANGING SETS

TWISTER HANGING SETS 1 mm		TWISTER HANGING SETS 2 mm					
max. 5 kg	max. 10 kg	max. 4 kg	max. 5 kg	max. 7 kg	max. 15 kg	max. 20 kg	max. 20 kg
Twister 1 mm Perlon 150 cm + Micro Grip 1 mm (5 kg)	Twister 1 mm Steelwire 150 cm + Micro Grip 1 mm (10 kg)	Twister 2 mm Perlon 150 cm + Hook 9.4205 (4 kg)	Twister 2 mm Perlon 150 cm + Hook 9.4207 (5 kg)	Twister 2 mm Perlon 150 cm + Hook 9.4209 (7 kg)	Twister 2 mm Perlon 150 cm + Hook 9.4261 (15 kg)	Twister 2 mm Perlon 150 cm + Micro Grip 2 mm (20 kg)	Twister 2 mm Perlon 200 cm + H100 3021.100 (20 kg)
Hanging Set	Hanging Set	Hanging Set	Hanging Set	Hanging Set	Hanging Set	Hanging Set	Hanging Set
30.42100	30.42150	9.6670	9.6671	9.6672	9.6674	30.42200	7026.200

SLIDER ECONOMY HANGING SETS 2 mm			STOPPER SET SLANTING WALLS	
max. 4 kg	max. 5 kg	max. 7 kg	max. 4 kg	
Slider Economy 2 mm 150 cm + Hook 4 kg (9.4205)	Slider Economy 2 mm 150 cm + Hook 5 kg (9.4207)	Slider Economy 2 mm 150 cm + Hook 7 kg (9.4209)	Solid Slider 2 mm Perlonwire 150 cm + Hook 4 kg (9.4205) + Stopper Slanting Walls	Stopper Slanting Walls
Hanging Set	Hanging Set	Hanging Set	Hanging Set	Hanging Set
9.9004	9.4400	9.4402	9.6645	9.4235
				Allen Key
				9.3392



installation video

hanging wires and hooks
MISCELLANEOUS

TWISTER HOOK



	Twister Hook
SIZE	35x4x15 mm
MAX. CAPACITY	MAX. 1 kg
ARTICLE NO.	9.4510

Compatible with all Artiteq Picture hanging systems

LOOP MAKER



	Loop Maker	Hanging Set 2x Twister Perlon 2 mm 150 cm + Loop Maker
SIZE	0,5 x 10 mm	
MAX. CAPACITY	max. 1 kg	
ARTICLE NO.	9.4218	9.6644

Compatible with all perlon wires 2 mm, see page 68-69

The Twister Hook completely replaces the hanging wire and hook. This plastic hook can provide an economical and practical solution for hanging light panels, artwork or, for example, a light string or garland for decoration, in combination with a picture hanging system. The maximum load capacity of the Twister Hook is 1 kg. The Twister Hook can be clicked into the rail at any position; turn in, click in and done.

The Loop Maker offers a solution for hanging objects if a hook cannot be used. As it is possible to create a loop with the 2-mm perlon hanging wire, it is possible to hang much more than just a picture frame!



hanging wires and hooks
MISCELLANEOUS

PICTURE MOUSE



	Picture Mouse White
	150 cm
ARTICLE NO.	7805.014

Compatible with all artiteq picture hanging systems

Picture Mouse is a handy and original hanging cord for displaying several documents, such as cards and photos. It can also be used as a 'solo' version rather than as part of a picture hanging system. The Picture Mouse Solo system is simple to install by mounting the wall clip to the wall. The steel Picture Mouse cord can be inserted and is hung from the wall clip.

PICTURE MOUSE SOLO (COMPLETE SET)

	1x	1x	10x
Picture Mouse Solo	Picture Mouse White	Wall Clip + Cover (With Fastener Material)	Picture Clip Transparent
	150 cm		
ARTICLE NO.	7840.100		

As well as the transparent clips, magnets can also be used on the Picture Mouse cord. The Mouse Magnets, available in white or in colour, combine perfectly with the Picture Mouse cord.

Picture Clip Transparent	Mouse Magnets White	Mouse Magnets Colour
ARTICLE NO.	7805.007	7430.020
		7430.010



PICTURE HANGING SYSTEMS

SOLO HANGING SYSTEMS

- Botaniq hanging flowerpot
- Uniq Hanger
- Solohanger
- Display It Solo
- H300 Panel Display Set
- Drop Ceiling Clipphanger
- Partition Wall Hooks



solo hanging systems

BOTANIQ

1 kg

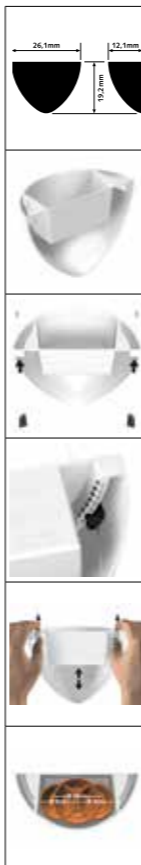

Make room for plants on the wall

There is always room for plants in your home or office. Create a surprising and dynamic effect with the Artiteq Botaniq hanging flowerpot. Hang your plants optimally with the stylish Botaniq with soft round shapes. The Botaniq comes with two 1mm perlon Twister hanging wires and two Micro Grip hooks, so you can easily hang it at the right height within Artiteq's hanging rail. The Botaniq hanging flowerpot can only be used in combination with a picture hanging rail. Choose your color and combine with several other hanging pots at different heights to give your interior an urban jungle and natural touch!

BOTANIQ COMPLETE SET



Botaniq White 1,25 l

Botaniq Green 1,25 l

SIZE*	261x192x121 mm	261x192x121 mm
MAX. WEIGHT	5 kg	5 kg
ARTICLE NO.	7600.110	7600.120

*Compatible for pot size of max. ø10 cm

2x	2x	1x
Micro Grip 1 mm	Twister Perlon 1 mm 150 cm	Botaniq Hanging Flowerpot White / Green*



solo hanging systems
UNIQU HANGER

5/10
kg

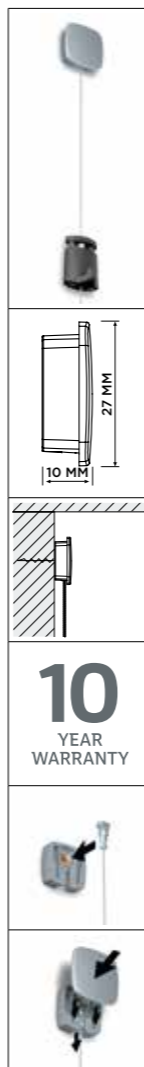

A different way to hang wall decorations

In some spaces, it either isn't possible or desirable to use a hanging rail. The Uniq Hanger offers a solution for these situations. Not only is it easy and safe to hang a picture frame on the wall and easily adjust the height, but it also creates a certain look. The combination of the stainless steel button with the steel wire might result in just the look you want to create in an interior. You also have the option of fully concealing the system behind your photo frame or painting.

Hanging a frame without a rail

The Uniq Hanger consists of a wall fitting with cover, Twister 1 mm steel wire and a Micro Grip 1 mm suspension hook. It's easy to insert the steel wire in the wall fitting, and then just slide the stainless steel cover over this. After you slide the Micro Grip 1 mm over the steel wire, you can adjust the height. The Uniq Hanger may also be used with perlon hanging wires.

UNIQU HANGER

ø 6mm	max. 10 kg	max. 5 kg
Uniq Hanger	Set Uniq Hanger Twister 1 mm Steelwire 200 cm + Micro Grip 1 mm	Set Uniq Hanger Twister 1 mm Perlon 200 cm + Micro Grip 1 mm
ARTICLE NO. 7805.042	7840.220	7840.240

solo hanging systems

NEWLY SOLOHANGER

4/20
kg



A great solution for flexibility with a minimum of installation needed. Perfect to hang from a ceiling but also useful to hang on a small wall, columns, shop windows and steel ceilings. The Solohanger offers the possibility to hang more than 1 object on the same cord to a total maximum of 20 kg per set.

The Solohanger is available as a set with a steel wire or perlon wire.

The set with perlon wire comes together with the H10 hook 4 kg, a 200 cm long perlon wire, mountingfoot, closing cap and plug and screw.

The set with steel wire comes together with the H100 hook 20 kg, a steel wire (can choose between 100 cm, 200 cm or 500 cm long), mountingfoot, closing cap and plug and screw.



installation video

SOLOHANGER

	max. 20 kg	max. 4 kg
	Newly Set Solohanger - Steelwire 20 kg	Newly Set Solohanger - Perlon
ARTICLE NO. 100 cm	7030.100	-
ARTICLE NO. 200 cm	7030.200	7035.200
ARTICLE NO. 5100 cm	7030.500	-

solo hanging systems



DISPLAY IT SOLO SET



A sleek hanging system for walls

Display It Solo Set is a hanging system for plates with thicknesses ranging from 3 to 6 mm, making it ideal for hanging Plexiglas and acrylic plates. With this system photos can be displayed in a sleek and safe way on the wall. Display It Solo Set is a display system that is easy to mount to the wall. The system consists of 2 buttons that are mounted to the wall, and then the Twister hanging cords are then Twister hanging cords hooked into them. Using the 4 clamps, you then attach the acrylic or Dibond plate to the perlon wire. This display system may also be used in combination with our hanging rails.

DISPLAY IT SOLO SET

				
	4x	2x	2x	2x
	Clamp Single 3-6 mm	Wall Clip + Cover White	Fastener Material	Twister 2 mm Perlon
		Plastic		200 cm
ARTICLE NO.	7840.150	7805.030	7805.040	9.4929 / 9.4930 / 9.3394
				09.23200

solo hanging systems

NEWLY H300 PANEL DISPLAY SET

 10 kg



The H300 Panel Display hanger is the perfect and only solution to hang dibond, plexiglass, wood panels, carton, aluminium or any other material with a thickness between 3 and 6mm and a weight of 10 kg on a hanging system without glueing, nailing or making any holes into the object. Installing is simple due to a flexible clamping system.

The H300 set consists of 2 self-locking lower clamps, 2 upper clamps and an instruction sheet but excluding the hanging wires.

NEWLY H300 PANEL DISPLAY HANGER SET

	
	Newly H300 Panel Display Hanger set
ARTICLE NO.	7070.300



10
YEAR
WARRANTY



installation
video

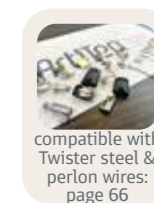

compatible with
Twister steel &
perlon wires:
page 66

solo hanging systems
DROP CEILING CLIPPHANGER

4/5
kg



10
YEAR
WARRANTY



installation
video

Hanging set for hanging frames on a drop ceiling

Versatile and efficient drop ceiling hanging solution to hang (light) posters, paintings and frames from a drop ceiling. The Drop Ceiling Clipphanger has a quick and easy installation. Slide the Drop Ceiling Clipphanger onto the drop ceiling at the end of the wall. The perlon wire 200 cm is already attached to the clip. Attach the hook onto the perlon wire for hanging posters, frames, or paintings with a maximum weight of 4 kg.

DROP CEILING CLIPPHANGER



Set Drop Ceiling Clipphanger White
1x 200 cm Perlon Wire + Mini Hook 4 kg



Set Drop Ceiling Clipphanger Black
1x 200 cm Perlon Wire + Mini Hook 4 kg



Newly Set Ceilinghanger
200 cm - Perlon Cord 5 kg



Newly Set Ceilinghanger Black
200 cm - Perlon Cord 5 kg

ARTICLE NO.

7807.560

7807.561

7040.200

7041.200



picture hanging systems - solo
PARTITION WALL HOOKS



HOOKS



	Partition Wall Hook		
SIZE	16 mm	21 mm	31 mm
COLOUR	White	White	White
MAX. CAPACITY	15 kg	15 kg	15 kg
ARTICLE NO.	9.4503	9.4504	9.4506

HANGING WIRES



9.4424	Slider Economy	2 mm	100 cm
9.4425	Slider Economy	2 mm	150 cm
9.4426	Slider Economy	2 mm	200 cm
9.4427	Slider Economy	2 mm	250 cm
9.4428	Slider Economy	2 mm	300 cm



Micro Grip 2 mm
30.41200 | 20 kg



Micro Grip Lock 2 mm
30.41250 | 20 kg

For overview hooks and hanging sets see page 64-75.

Flexible and solid

Since it is not always possible (or allowed) to hang rails in every room, we also offer solutions for hanging pictures and wall decorations in the form of partition wall hooks. We offer a range of various types of partition wall hooks for rooms with partitions, giving you a solid, practical way to hang pictures and decorations even on these types of walls. Partition wall hooks are hung over the top of a wall, and then used in combination with a perlon or other type of cord fitted with a picture hook. We offer a variety of solutions depending on the weight of the picture or decoration to be hung.

HOOKS



	Partition Wall Hook			Partition Wall Hook Flex	
SIZE	16 mm	21 mm	31 mm	11-30 mm	
COLOUR	White	White	White	Stainless Steel	White
MAX. CAPACITY	15 kg	15 kg	15 kg	3 kg	3 kg
ARTICLE NO.	9.4503	9.4504	9.4506	9.4540	9.4541

HOOKS



	S-Hook	Gallery Hook			Gallery Hook Large		
SIZE	2 mm	18 mm			20 mm		
COLOUR	WHITE	White	Nickel-Plated	Brass	White	Nickel-Plated	Brass
MAX. CAPACITY	20 kg	12,5 kg	12,5 kg	12,5 kg	20 kg	20 kg	20 kg
ARTICLE NO.	9.4500	9.4239	9.4238	9.4241	9.4247	9.4246	9.4248

HANGING WIRES



9.4412	Perlon + Loop	2 mm	100 cm
9.4413	Perlon + Loop	2 mm	150 cm
9.4414	Perlon + Loop	2 mm	200 cm
9.4415	Perlon + Loop	2 mm	250 cm
9.4416	Perlon + Loop	2 mm	300 cm
9.4975	Steelwire + Loop	2 mm	100 cm
9.4976	Steelwire + Loop	2 mm	150 cm
9.4977	Steelwire + Loop	2 mm	200 cm
9.4979	Steelwire + Loop	2 mm	300 cm



Micro Grip 2 mm
30.41200 | 20 kg



Micro Grip Lock 2 mm
30.41250 | 20 kg

For more hooks see page 70.

picture hanging systems - solo
MAGNETIC PICTURE HOOKS



7410.001	Magnetic Picture Hook Steel	100 x 53 mm	max. 1 kg
7410.002	Magnetic Picture Hook Steel	100 x 200 mm	max. 4 kg
7410.003	Magnetic Picture Hook Steel	150 x 250 mm	max. 6 kg
7410.004	Magnetic Picture Hook Steel	200 x 300 mm	max. 12 kg

picture hanging systems - solo

PARTITION WALL HOOKS

i.c.m. obimex / alcoa / sypla / systemflex / interselect partition walls





HOOKS		
	White	Black
		
	Wall Hook Systemflex / Interselect	Wall Hook Systemflex / Interselect
COLOUR	White	Black
MAX. CAPACITY	5 kg	5 kg
ARTICLE NO.	9.4520	9.4521



HOOKS		
	White	Black
		
	Wall Hook Alcoa / Sypla / Obimex	Wall Hook Alcoa / Sypla / Obimex
COLOUR	White	Black
MAX. CAPACITY	5 kg	5 kg
ARTICLE NO.	9.4522	9.4523

1 mm					
Twister 1 mm					
	30.21150	Twister	1 mm	Perlon	150 cm
	30.21200	Twister	1 mm	Perlon	200 cm
	30.21300	Twister	1 mm	Perlon	300 cm

2 mm					
Twister 2 mm					
	09.23100	Twister	2 mm	Perlon	100 cm
	09.23150	Twister	2 mm	Perlon	150 cm
	09.23200	Twister	2 mm	Perlon	200 cm
	09.23250	Twister	2 mm	Perlon	250 cm
	09.23300	Twister	2 mm	Perlon	300 cm
	09.23500	Twister	2 mm	Perlon	500 cm

1 mm					
Twister 1 mm					
	30.21150	Twister	1 mm	Perlon	150 cm
	30.21200	Twister	1 mm	Perlon	200 cm
	30.21300	Twister	1 mm	Perlon	300 cm

2 mm					
Twister 2 mm					
	09.23100	Twister	2 mm	Perlon	100 cm
	09.23150	Twister	2 mm	Perlon	150 cm
	09.23200	Twister	2 mm	Perlon	200 cm
	09.23250	Twister	2 mm	Perlon	250 cm
	09.23300	Twister	2 mm	Perlon	300 cm
	09.23500	Twister	2 mm	Perlon	500 cm



Micro Grip 1 mm
30.41100 | 5 kg



Micro Grip 2 mm
30.41200 | 20 kg

For more hooks see page 70.

For hanging on to partition walls

For areas where partitions are used to create quick and durable routes within (office) buildings, we have added two partition wall hooks to the range on the Obimex/ Alcoa/ Sypla and Systemflex / Interselect partitions. The wall hook is simply clicked into the desired location in the system wall and then used in combination with an Artiteq Twister Perlon hanging wire of 1 mm or 2 mm with picture hook. The wall hook has a maximum carrying capacity of 5 kg.

2 mm					
Slider Economy 2 mm					
	9.4424	Slider Economy	2 mm	Perlon	100 cm
	9.4425	Slider Economy	2 mm	Perlon	150 cm
	9.4426	Slider Economy	2 mm	Perlon	200 cm
	9.4427	Slider Economy	2 mm	Perlon	250 cm
	9.4428	Slider Economy	2 mm	Perlon	300 cm



Micro Grip 1 mm
30.41100 | 5 kg



Micro Grip 2 mm
30.41200 | 20 kg

For more hooks see page 70.

FRAME ACCESSORIES

FRAME ACCESSORIES SECURED

- securely fixing and hanging art directly onto the wall
- secure hanging in combination with a picture hanging system
- for hanging art at a slight angle
- for a safe and secure transport
- safe depot storage

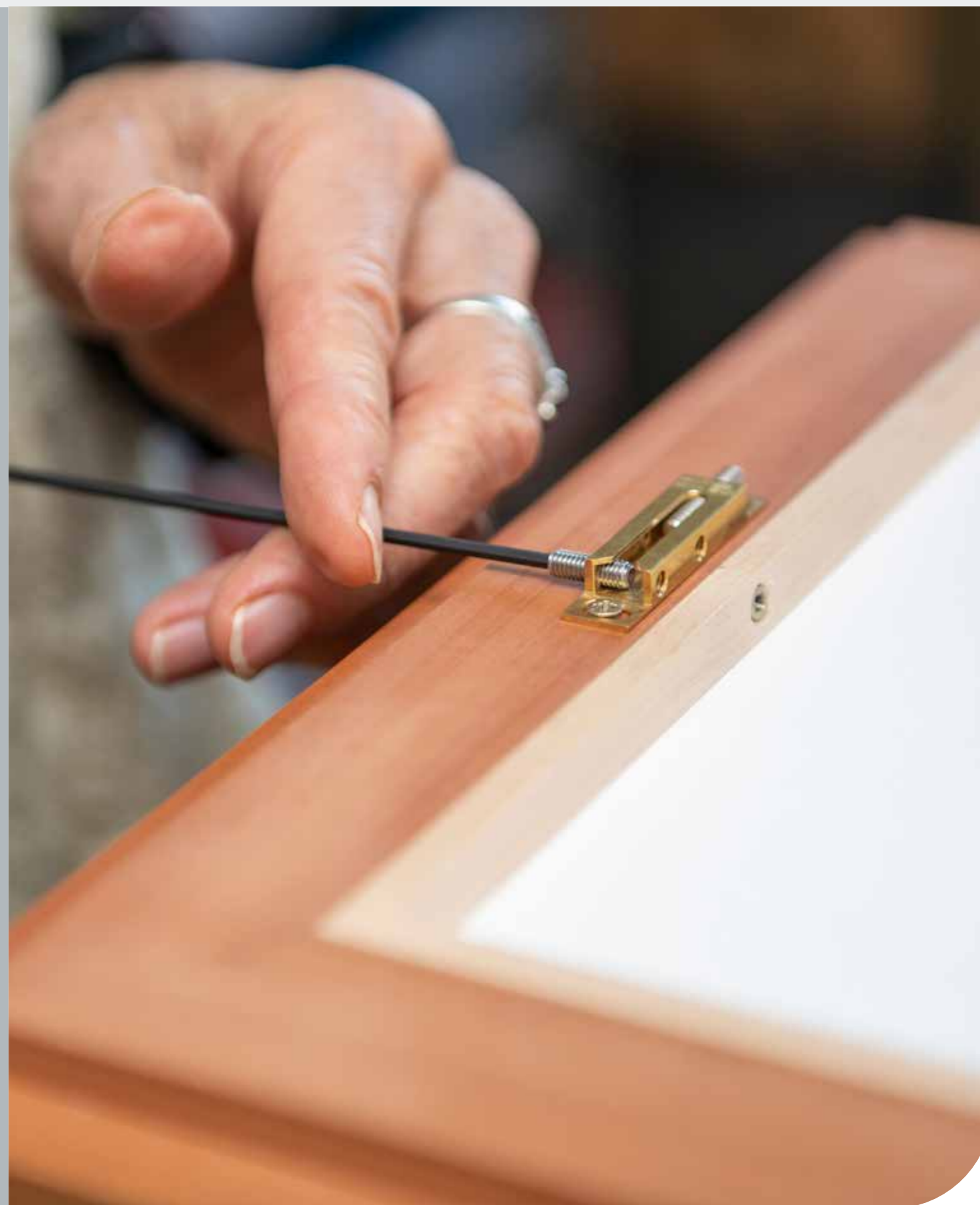

WALL HANGING - FRAME HANGERS

securely hanging and fixing art directly onto the wall

For the secure hanging and fixing of artworks, paintings, and (heavy) frames firmly to the wall, Track & Slide® offers a range of frame hangers like the **Track Junior** and **Track Junior M**.

This product range is mounted directly, and only once, onto the back of a painting or frame. The appropriate type is selected based on the size and weight of the artwork. The system includes mechanical anti-theft protection and allows for both vertical and horizontal adjustment. Two units are required per painting.

These are a versatile and reliable solution for not only secure hanging, but also depot storage, safe transportation of artworks and hanging paintings in combination with a track (picture hanging system).

FRAME HANGERS (units mounted on frame)

		
max. 80 kg per set / 2 pc	max. 120 kg per set / 2 pc	max. 160 kg per set / 2 pc
Track Junior 40 kg*	Track Junior BU 60 kg*	Track Junior M 80 kg**
ARTICLE NO. TS94374	TS94360L & TS94360R	TS94615

* Track Junior & Track Junior BU can be used in combination with the Depot Screw Junior/ Junior BU (TS90635).

** Track Junior M can be used in combination with the Extender Junior M (TS21160) and the Depot Screw Junior M (TS90935).

Two units are required per painting, frame or art object.

FRAME HANGERS (units mounted on frame)

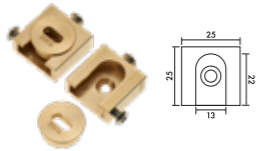
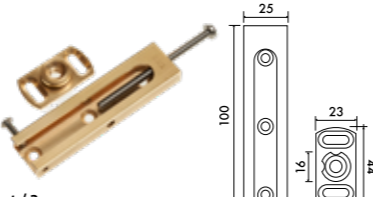
	
max. 160 kg per set / 2 pc	max. 200 kg per set / 2 pc
Track & Slide S L & R 80 kg	Track & Slide M 100 kg
ARTICLE NO. TS92525L & TS92525R	TS91100

Two units are required per painting, frame or art object.

SECURELY HANGING AND FIXING ART DIRECTLY ONTO THE WALL



Reasons why to choose Track Junior / Track Junior M:

- High-quality brass and stainless steel parts
- Easy to use
- Adjustable on the wall without re-hanging - adjustment max. ca. 3 cm
- Anti-theft protection
- Storage hanging
- Transportation safety
- Air circulation (8 mm distance from the wall)
- High weight-bearing capacity (80, 120, 160 or 200 kg per set)
- Two units per painting or frame are required

Step 2: Hang the frame onto the screw

Carefully place the frame on the screw on the wall. Slide the frame downward so that it clicks into position securely. Adjust the frame from the top for parallel hanging.

Step 3: Secure the anti-theft lock

Once the frame is in place, tighten the side security screw to lock the system and activate the anti-theft function.

In just three steps, the Track Junior / Track Junior M are securely mounted to the back of a painting or work of art. In this way, the painting hangs directly against the wall.

Installation instructions - Track Junior M

Step 1: Position the Track Junior M on the frame

Mount the Track Junior M in the center of the back of the frame. Make sure the distance between both sides on the frame are equal. Ensure it is straight, then fasten it. The screws on the wall are positioned at the same distance as the Track Junior M on the back of the painting.

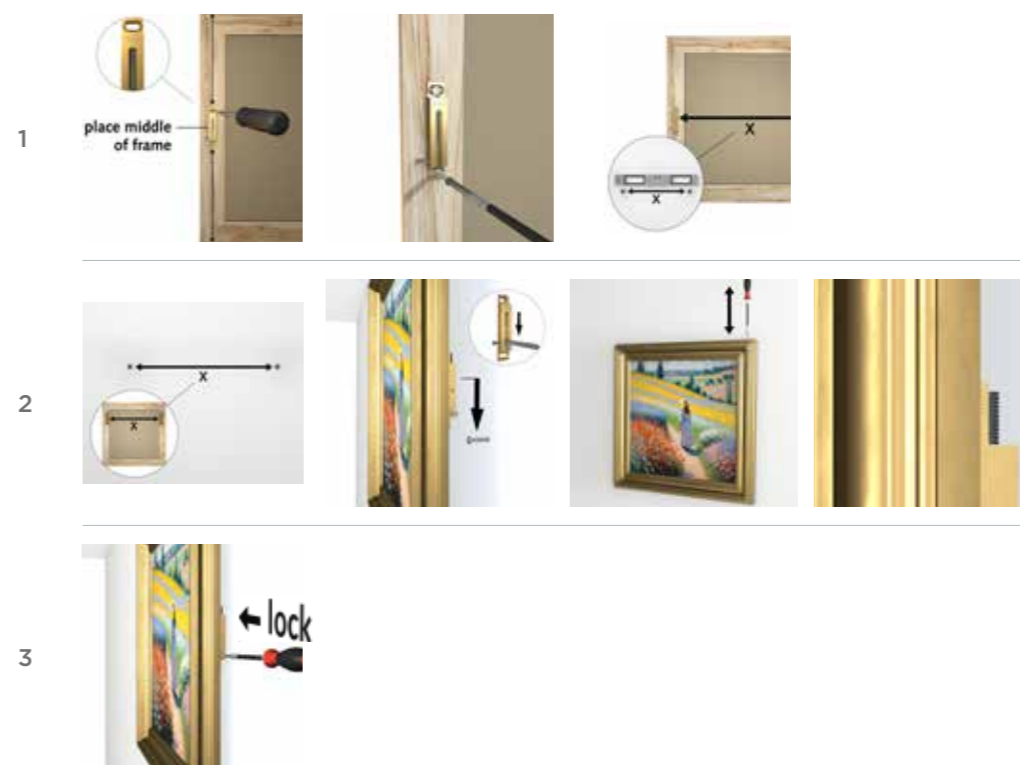

WALL HANGING - FRAME HANGER JUNIOR

for a secure hanging in combination with a picture hanging system

The Frame Hanger Junior is a smart and secure solution for hanging frames that are already equipped with a Track Junior M element on the back. It is specifically designed for situations where the frame needs to be suspended from a picture hanging system using steel wire.

Instead of attaching additional or creating new mounting points, which can damage the back of the painting, the Frame Hanger Junior allows to reliably connect the Track Junior M to the hanging wire. This ensures a clean and damage-free installation, especially for frames that are already fitted with the Track Junior M.

FRAME HANGER JUNIOR

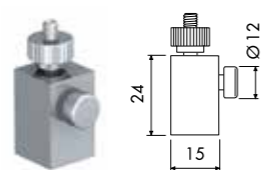

Frame Hanger Junior M 1.2-1.8 mm / 15-40 kg

ARTICLE NO.

TS94620*

* used in combination with Track Junior M (TS94615). Two units are required per painting, frame or art object.

Installation instructions - Frame Hanger Junior

Step 1: Insert the wire into the Frame Hanger Junior

Thread the steel wire through the Frame Hanger Junior. It will automatically lock into place once released. Insert the wire into the picture hanging system at the desired position in the rail.

Step 2: Attach the Frame Hanger Junior to the Track Junior M

Connect the Frame Hanger Junior to the Track Junior M on the back of the frame.

Step 3: Lock

Lock it by adjusting the screw and tightening the screw on the Frame Hanger Junior M.

Step 4: Positioning the painting

Position the painting at the preferred height by adjusting the steel wire in the Frame Hanger Junior.



WALL HANGING - HOOK4WALL T&S

for hanging and securing art on the wall

The Hook4Wall is a smart and reliable solution for hanging paintings and artworks directly on the wall. The Hook4Wall is used when at the back of the painting or artwork, a ring screw is already attached.

Use two Hook4Wall units to securely mount a frame or painting. Placement on the wall depends on the position of the hanging accessory (such as a ring screw) on the back of the frame or painting.

The Hook4Wall includes a locking screw to ensure a safe, stable and secure installation.

What makes the Hook4Wall truly stand out is its combination of strength, safety, and flexibility. With its high weight capacity (50 kg per unit), it's perfect for even the heaviest frames. The design is adjustable, making it easy to align your artwork exactly as you want it. And thanks to the built-in anti-theft feature, you can trust that your pieces stay secure, whether in a gallery or in a public space.

HOOK4WALL (unit mounted on wall)

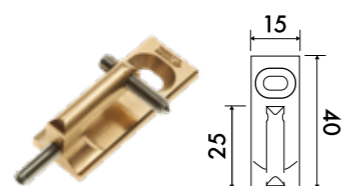

max.
100 kg
per set / 2pc

Hook4Wall 50 kg *

ARTICLE NO.

TS00011

* Hook4Wall can be used in combination with the Extender Junior M (TS21160). Two units are required per painting, frame or art object.



Reasons why to choose Hook4Wall:

- High-quality brass and stainless steel parts
- Easy to use
- Adjustable on the wall without re-hanging - adjustment max. ca. 6.5 cm
- Security through horizontal security screw
- Can be used with ring screws up to 6 mm
- High weight-bearing capacity (100 kg per set)
- Two units per painting or frame required

With just a few easy steps, the Hook4Wall provides a secure way to hang your artwork directly on the wall.

Installation instructions - Hook4Wall

Step 1: Position the Hook4Wall on the wall

Place both Hook4Wall at the same distance apart as the existing elements on the back of the painting or frame. Once mounted on the wall, remove the horizontal screw in order to hang the painting onto the Hook4Wall.

Step 2: Hang the frame onto the screw

Carefully place the ring screw (on the back of the painting) over the Hook4Wall. Adjust the vertical screw to make any necessary adjustments in height. Do this on both Hook4Wall elements.

Step 3: Secure the anti-theft lock

Replace the horizontal screw in order to secure the painting onto the wall. The painting is now secured.

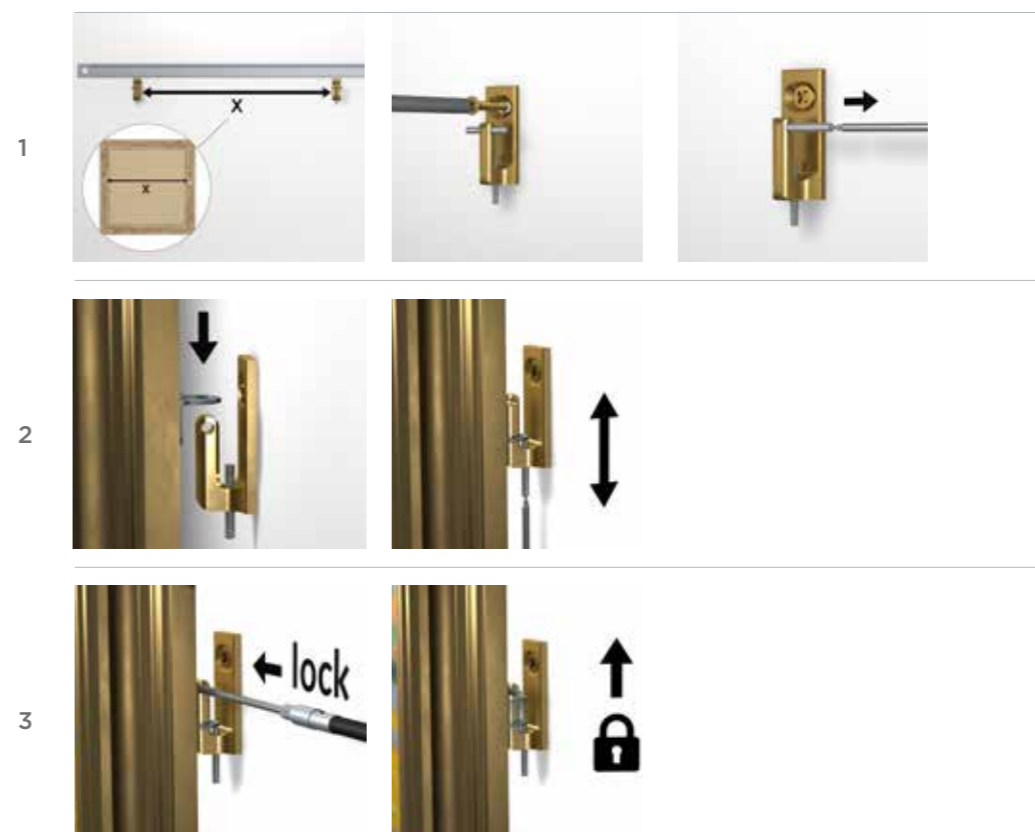

ACCESSORIES - EXTENDER

for hanging a painting at a slight angle

There is a whole range of accessories compatible with the frame hangers, such as the Track Junior M. One such accessory is the Extender Junior M, which is used in conjunction with the Track Junior M to create more distance between the painting and the wall, or to hang a painting at a slight angle.

This extra space can be particularly beneficial in museum environments, where air circulation behind the painting is often required to support art conservation. Proper airflow helps protect fragile artworks from damage caused by humidity or stagnant air.

An important advantage is that the Extender Junior M allows for this spacing without needing to alter or mount anything to the back of the artwork, a crucial requirement in the museum world, where many pieces are delicate and must remain untouched.

EXTENDER

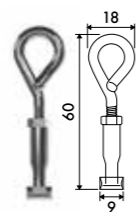

Extender Junior M

ARTICLE NO. TS21160*

*Extender Junior M used in combination with the Track Junior M (TS94615) and Hook4Wall (TS00011).

SET



max.
50 kg

Track Junior M + Extender Junior M + Hook4Wall

ARTICLE NO. TS91150

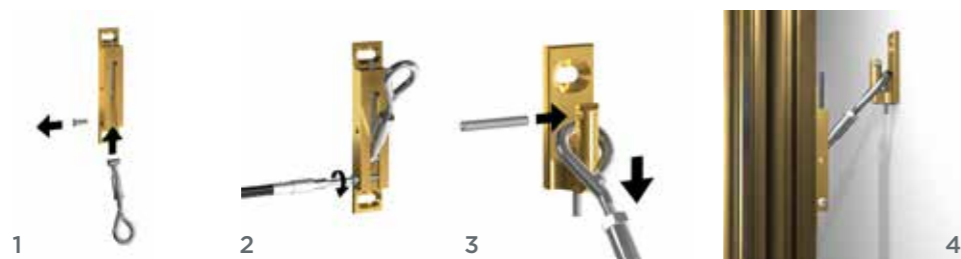

ACCESSORIES - TRANSPORT

for a safe and secure transport

Art is often loaned between museums and exhibition spaces. Transporting these valuable and often fragile works must be done with great care and security. The Track & Slide® Transport Security Set is designed specifically for this purpose.

Used in combination with frame hangers like the Track Junior M, the system enables safe and stable transport of artworks. An important advantage is that this method does not require any modifications to the back of the painting, preserving the integrity of the artwork, a crucial aspect in the museum world.

TRANSPORT



Transport Security Set

Ring Screw M4 x 50

Ring Screw M4 x 60

Ring Screw M4 x 80

Spacer Junior

ARTICLE NO. TS4000 TS16450S TS16460S TS16480S TS17450X

Used in combination with Track Junior (TS94374), Track Junior BU (TS94360L / TS94360R), Track Junior M (TS94615), Track & Slide S (TS92525L / TS92525R) and Track & Wire (TS30218).

This is necessary for safe and secure transport: Transport Security Set, Ring Screw and Spacer Junior

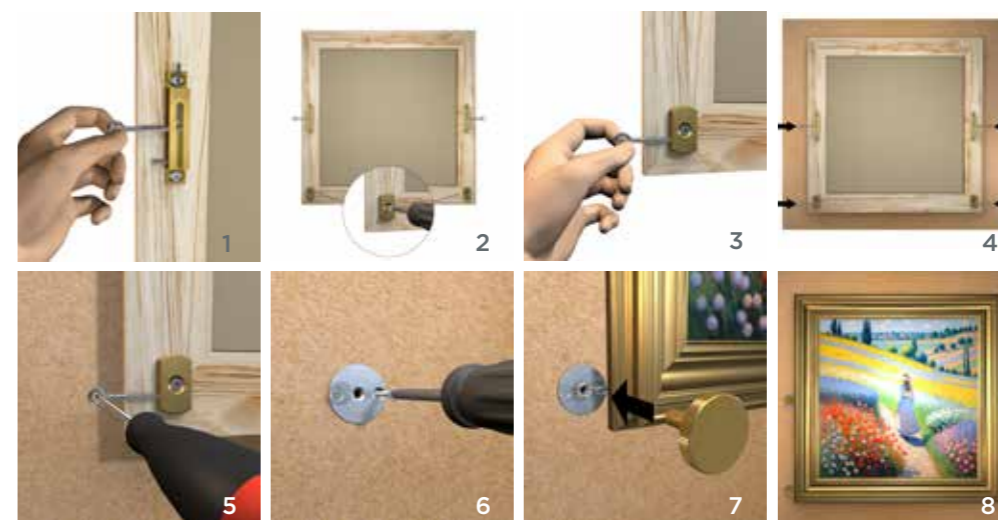

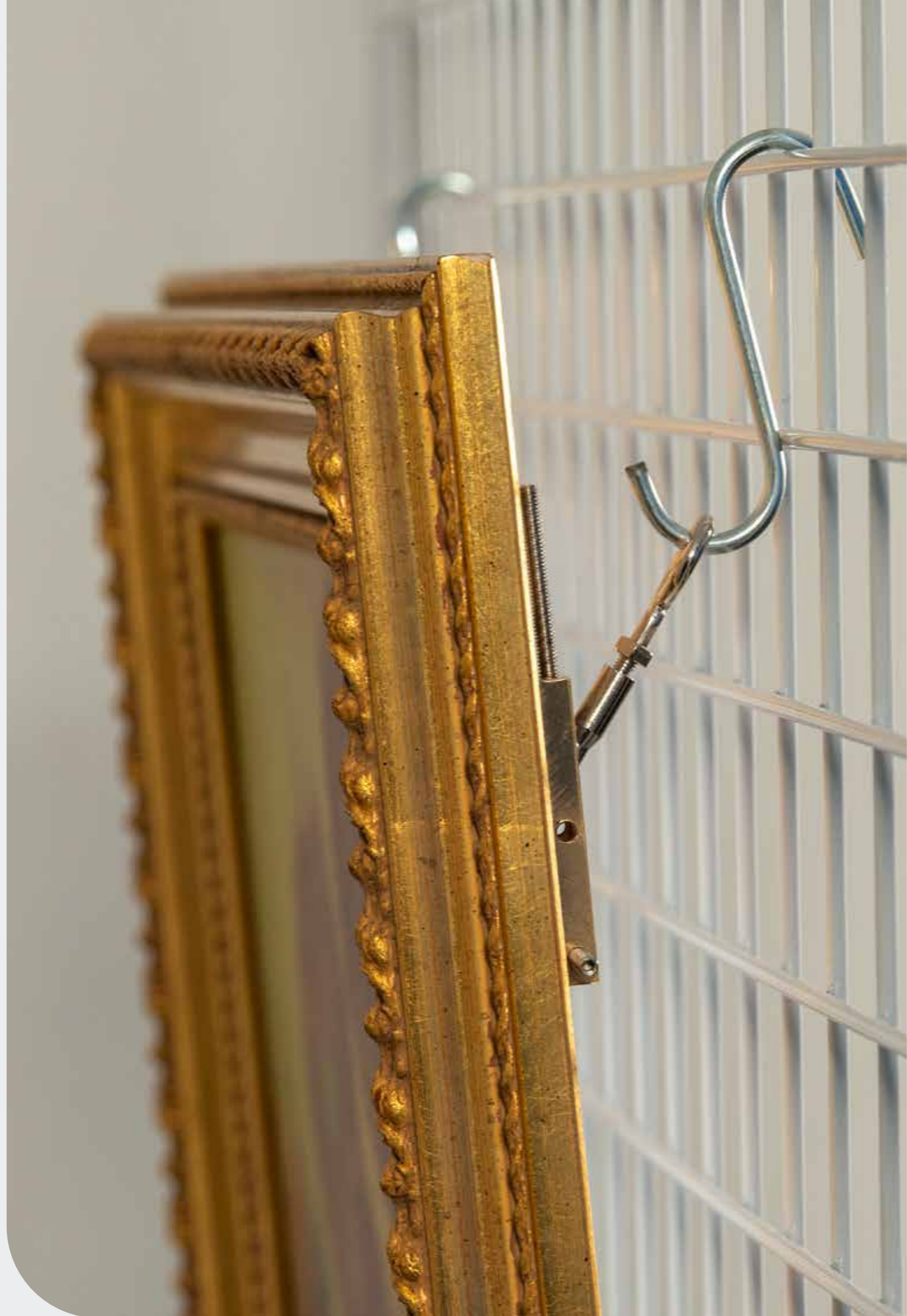

ACCESSORIES - DEPOT

for a safe storage in depot

More than half of the painting collections of museums are not displayed for visitors to see. These paintings and art objects are safely stored and kept in a depot storage within the museum. Also here, a safe and easy hanging of the paintings and artworks is important.

Will the painting be stored in a depot? Depot Screws are used in combination with a frame hanger such as the Track Junior M to easily and safely hang and store it on grid walls.

Depending on which type of frame hanger is attached behind the art object or painting, the appropriate Depot Screw is chosen.

DEPOT

			
	Depot Screw Junior / Junior BU	Depot Screw Junior M	Extender Junior M
ARTICLE NO.	TS90635*	TS90935**	TS21160***
SIZE	35 x 30 mm	35 x 35 mm	

* used in combination with Track Junior (TS94374) and Track Junior BU (TS90635).
 ** used in combination with Track Junior M (TS94615).
 *** used in combination with Track Junior M (TS94615) and Hook4Wall (TS00011)

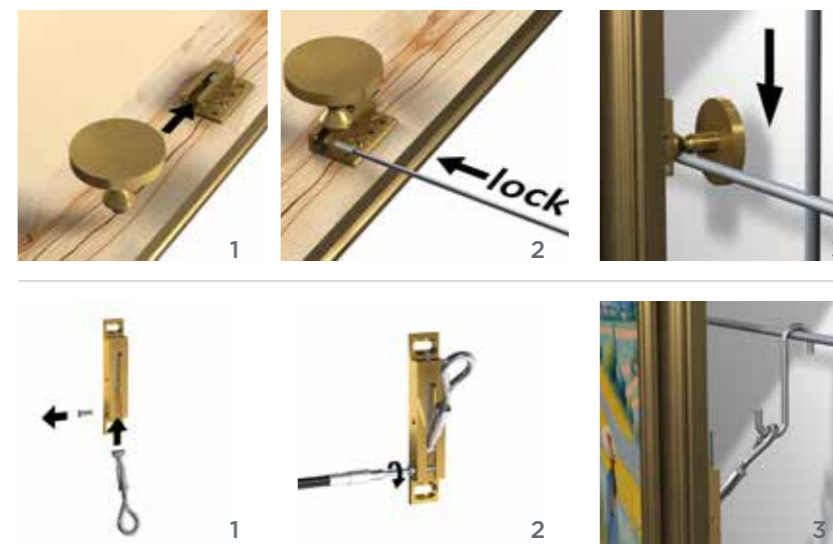

MOUNTING TOOLS

necessary tools & bits

TOOLS



Flexible Bitholder

ARTICLE NO. TS9001

BITS



Secure Bit Junior M

ARTICLE NO. TS9007



Adjustment Bit Junior

ARTICLE NO. TS9005



Adjustment Bit M / L

ARTICLE NO. TS9002

Bits TS9007, TS9005 and TS9002 are always combined with the Flexible Bitholder, TS9001.

TOOLS



Assembly Tool Junior

ARTICLE NO. TS9008 TS9008L

SIZE 10,5 cm 29,7 cm

Our Mounting Tools are designed to ensure secure installation and easy adjustment of our Track & Slide® and Track & Wire® systems. These high-quality tools offer the precision and reliability needed for both initial setup and ongoing modifications, whether in gallery settings or retail environments.

In addition to general mounting, these tools are essential for properly fixing the Sliders (TS00005, TS00006) within the Double Wall Track and the Heavy Duty Track. This guarantees optimal performance of the system, helping to maintain both the safety and aesthetic integrity of the hanging setup.

Using the right tools ensures that your system performs at its best. See next page for an overview of which mounting tool is applicable for which Track & Slide® product.

MOUNTING TOOLS

correct tool use

				
	TS9008 TS9008L	TS9007	TS9001 +	TS9002
 TS94374	A + B		A + B	
 TS94369L TS94369R	A + B		A + B	
 TS94615	A	B	A	
 TS92525L TS92525R		A + B		
 TS91100		B		A
 TS00011	A + B		A + B	
 TS30218		B		
 TS00005	A		A	
 TS00006	A		A	

FRAME ACCESSORIES

- accessories for behind a wooden frame
- safe and solid secure frame for behind a dibond panel
- accessories for behind a forex, dibond or plexiglass panel
- accessories for hanging plates and tiles



frame accessories
FOR BEHIND FRAMES

When hanging wooden frames or paintings, it is important to use a good frame hanger that is compatible with Artiteq's hanging systems. A frame hanger is an important component for correctly hanging a frame or painting. Artiteq has some frame hangers for a wooden frame or painting.



Z100 Powerbar 40 cm 12 kg	Z100 Powerbar 60 cm 18 kg	Z100 Powerbar 100 cm 30 kg	Z100 Powerbar 200 cm 30 kg p/m
Pair of 2	Pair of 2	P/10	P/10
ARTICLE NO. 7100.040	7100.060	7100.100	7100.200

Z100 Powerbar Installation Set 20 cm
2 plug, 2 screw 3,5 x 40 mm, 2 screw 3,5 x 12 mm
4045.020

ARTICLE NO.



Frame Hanger 1-1,5 mm Steelwire (max. 10 kg)	Frame Hanger 1,5-2 mm Steelwire (max. 15 kg)
ARTICLE NO. 7805.055	7805.050

ARTICLE NO.

Frame Hanger For Use With Wood	Set Frame Hangers L&R
ARTICLE NO. 808.650	808.600

ARTICLE NO.



Set D-Ring (1 Set) 5 Kg	D-Ring Hanger 5 Kg	Screw D-Ring
ARTICLE NO. 4055	805.249	9.4911

ARTICLE NO.

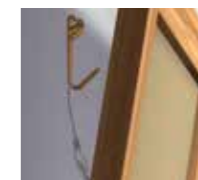
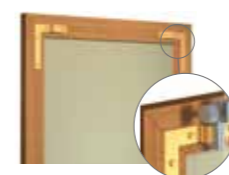

Set Framehook + Hanging (12 pieces)	Set Folding Eye (12 pieces)	Set Wall Hooks (12 pieces)	Set Concrete Hooks (12 pieces)
ARTICLE NO. 4056	4057	4059	4058

ARTICLE NO.



Security Set	Tilt Reducer 11x5x29 mm	Set Tilt Reducer (2 stuks)	Frame Hanger For Use With Aluminium
ARTICLE NO. 4054	805.300	9.6635	808.720

ARTICLE NO.

SPOOL



Steelwire 1 mm Spool 1x19	Steelwire 1,2 mm Spool 1x19	Steelwire 1,5 mm Spool 1x19	Perlon 2 mm Spool
ARTICLE NO. 100 m 9.4904	9.4955	9.4990	9.4404
ARTICLE NO. 500 m -	-	-	9.44215

ARTICLE NO. 100 m

ARTICLE NO. 500 m



Pressing Nipple 1-1,2 mm	Wire Clamp 1,5 mm Alu	Wire Clamp 2 mm Alu	Hanging Nipple max. 7 kg
ARTICLE NO. 9.4905	9.4430	9.4431	9.4211

ARTICLE NO.

frame accessories

ARTITEQ BACK FRAME HANGING SYSTEM



A **safe** and **solid** solution to hang printed panels. Adds **depth** and **shadow** between panel and wall. Adds **rigidity** to **flexible** panels made of aluminium (Dibond), forex or acrylic.

The Back Frame Hanging System is a mounting system especially for thin and flexible panels made of aluminium, forex or acrylic. It helps to stiffen the panel, while mounting is easy and safe. The leveling system provided by the Back Frame Corners is particularly convenient for the mounted panel allowing adjustment for the panel up to 6 mm. The panel will always be straight without drilling new holes.

The Back Frame Hanging System is available in 8 mm and 15 mm profiles, both in the versions alu mill finish and silver anodised.

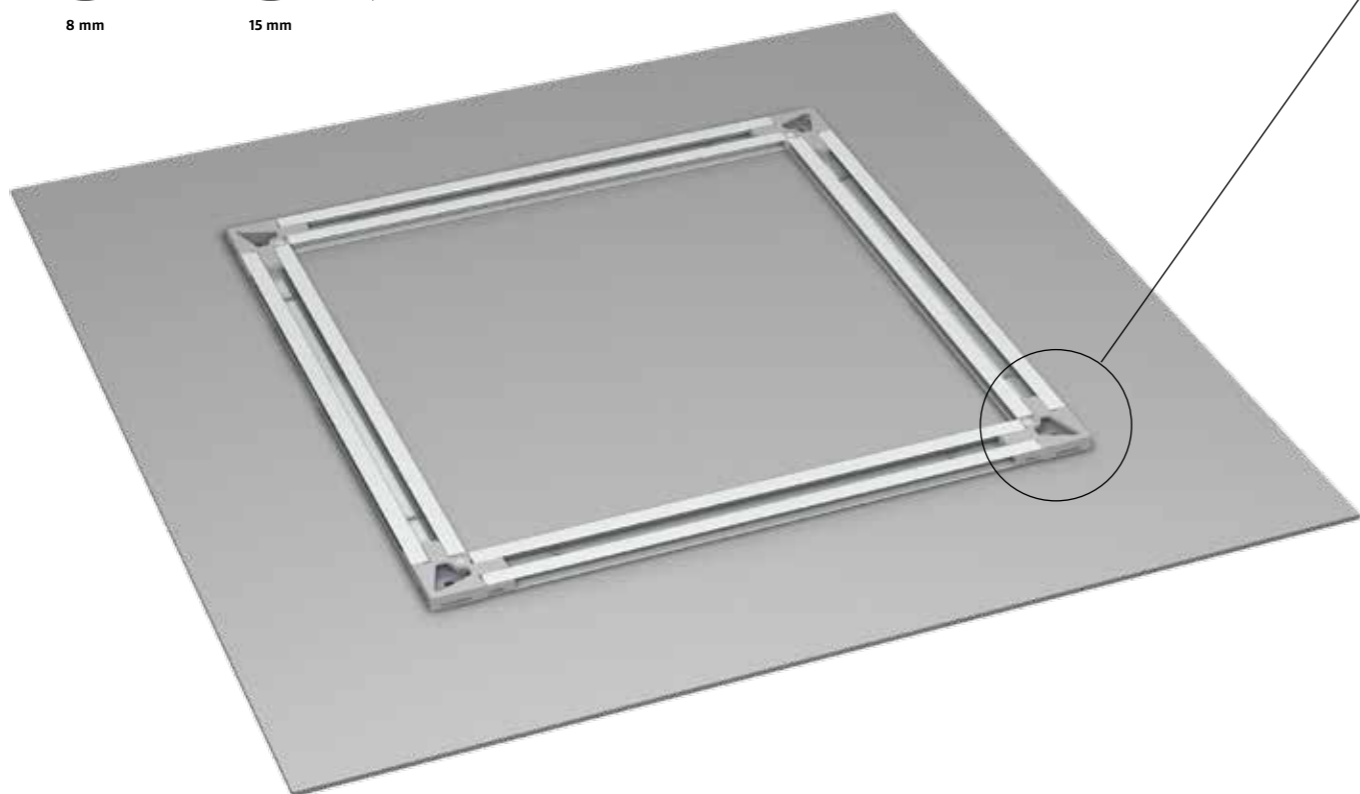
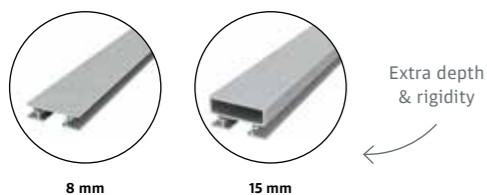

1. WALL PROTECTION INCORPORATED

Wall protection is incorporated in the Power Corners.



2. LESS TAPE, BETTER LOAD CAPACITY

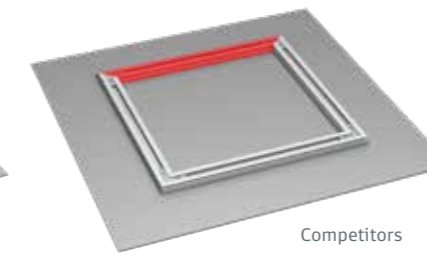
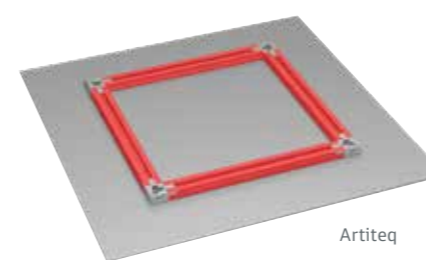

Rigid fixing thanks to steel spring!



Power Corners enable equal weight distribution because of rigid fixing thanks to steel spring in square-cut profiles instead of mitre-cut profiles.

3. EASY HANGING: 3 OPTIONS

The Artiteq Back Frame Power Corners provide 3 easy ways of hanging a printed panel : Fixed (1), Secured (2) and Flexible (3).

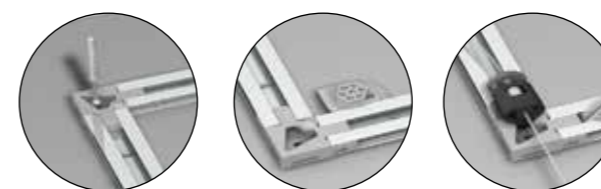

4. NO EXTRA ACCESSORIES NEEDED

The printed panel is hung using the Power Corners, no extra accessories needed.

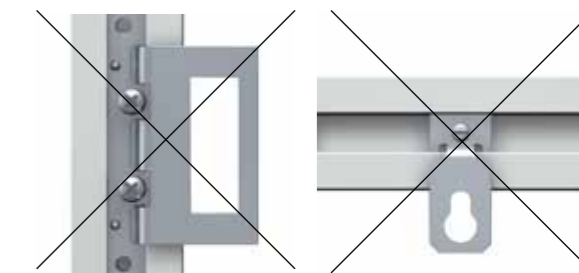

frame accessories

ARTITEQ BACK FRAME HANGING SYSTEM



The Back Frame Hanging System is available in 8 mm and 15 mm profiles, both in the versions alu mill finish and silver anodised.

A

For the correct sizing and positioning of the Back Frame Hanging System, we recommend placing the profiles at 100 mm from each side of the printed panel. When glueing the profiles to the back of the printed panels, we recommend using 3M tape (article number 05.16050).

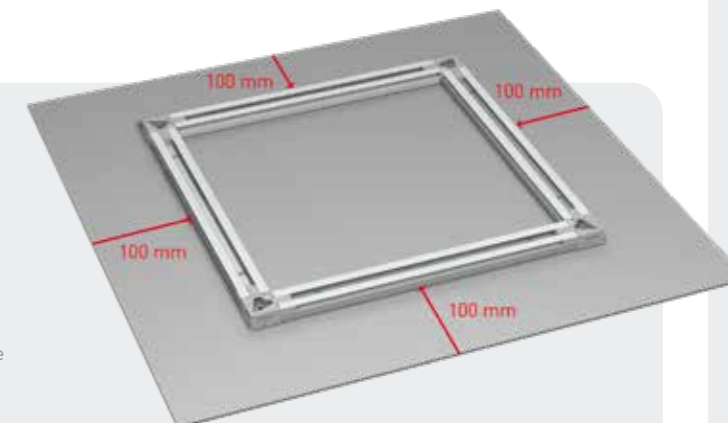

B

The 8-mm and 15-mm profiles for the Back Frame Hanging System can also be mitre-cut. The profiles will fit with a wide range of accessories available on the market.



C

We recommend using 3M tape (general advice 3M: 25 cm²/kg) for printed panels made of aluminium, hard-foam, forex, acryl and glass. The below table applies when Back Frame Hanging System profiles are applied at max. 100 mm from each of the sides of the printed panel (see A). The table applies for panels with a maximum total weight of 30 kg and a minimum size of 400 x 400 mm.



Material	Thickness	Tape	For Surfaces
Dibond	3-6 mm	Single tape 12 mm	Up to 4 m ²
Forex	3-5 mm	Single tape 12 mm	Up to 4 m ²
Acryl	3-5 mm	Single tape 12 mm	Up to 4 m ²
Glass	6 mm	Double tape 24 mm	Up to 2 m ²



installation video

BACK FRAME HANGING SYSTEM rail 8mm

05.16300	05.16301	05.16010
Back Frame Rail 8 mm 300 cm Alu Brute	Back Frame Rail 8 mm 300 cm Silver Anodised	Back Frame Power Corner 8 mm (set of 4)

BACK FRAME HANGING SYSTEM rail 15mm

05.17300	05.17301	05.17010
Back Frame Rail 15 mm 300 cm Alu Brute	Back Frame Rail 15 mm 300 cm Silver Anodised	Back Frame Power Corner 15 mm (set of 4)

BACK FRAME HANGING SYSTEM additions

05.16050	05.16055	05.16030	05.16040	05.16060
Tape 3M 12 mm 33 m	3M VHB Cleaning Tissues	Back Frame Security Key	Back Frame Flex Bumper	Set Back Frame Security Clip (4 Clips, 4 Plugs, 4 Screws)

SET* BACK FRAME HANGING SYSTEM ON LENGTH INCLUDING 3M TAPE MOUNTED

	Set 2x Back Frame Rail 8 mm 344 mm Alu Brute (40 cm)	Set 2x Back Frame Rail 8 mm 444 mm Alu Brute (50 cm)	Set 2x Back Frame Rail 8 mm 544 mm Alu Brute (60 cm)	Set 2x Back Frame Rail 8 mm 644 mm Alu Brute (70 cm)	
	05.16725	05.16726	05.16735	05.16745	
	Set 2x Back Frame Rail 8 mm 744 mm Alu Brute (80 cm)	Set 2x Back Frame Rail 8 mm 844 mm Alu Brute (90 cm)	Set 2x Back Frame Rail 8 mm 944 mm Alu Brute (100 cm)	Set 2x Back Frame Rail 8 mm 1044 mm Alu Brute (110 cm)	
	05.16746	05.16755	05.16756	05.16765	

* Set does not include power corners 8mm

frame accessories

DIBOND / FOREX / PLEXIGLASS PANELS

For hanging a panel made of Dibond, Forex or Plexiglas, Artiteq has Dibond Hangers. These Dibond Hangers are available in 4 different sizes, each with its own maximum load-bearing capacity.



	Dibond Hanger	Dibond Tuner
ARTICLE NO.	809.505 45 x 45 mm (max. 1 kg)	809.030
ARTICLE NO.	809.520 70 x 70 mm (max. 2 kg)	
ARTICLE NO.	809.530 100 x 100 mm (max. 4 kg)	
ARTICLE NO.	809.540 100 x 200 mm (max. 8 kg)	

*Wall bracket only in combination with Dibond Hangers 809.530 (100 x 100 mm) and 908.540 (100 x 200 mm).

ARTICLE NO.	Spacers Transparent, Self-Adhesive	Spacers Foam, Self-Adhesive
809.001	12,5 x 12,5 x 5,7 mm	809.002 20 x 20 x 15 mm

Dibond Tuner - adjustable mounting bracket

A plastic adjustable mounting bracket for solid and sturdy mounting of a Dibond, Forex or Plexiglas wall panel with a load capacity of up to 8 kg. The Dibond Tuner is adjustable. By turning it, the panel can be adjusted vertically (up to 4 mm). The Dibond Tuner can also be moved horizontally along the length of the Dibond Hanger. The ability to adjust allows the panel to be hung perfectly level!

First, mount the Dibond Tuner hanging bracket to the wall using the screw and plug provided. Then hang the wall panel with Dibond Hanger over the hanging bracket on the wall. The Dibond Tuner hanging bracket can be used in combination with all Dibond Hangers from 45 x 45 mm up to 100x 200 mm.



ARTICLE NO.	Set Dibond Hanger
9.6894	Set Dibond Hanger 1st 45 x 45mm (1kg)
9.6895	Set Dibond Hanger 1st 70 x 70mm (2kg)
9.6896	Set Dibond Hanger 1st 100 x 100mm (4kg)
9.6897	Set Dibond Hanger 1st 100 x 200mm (8kg)

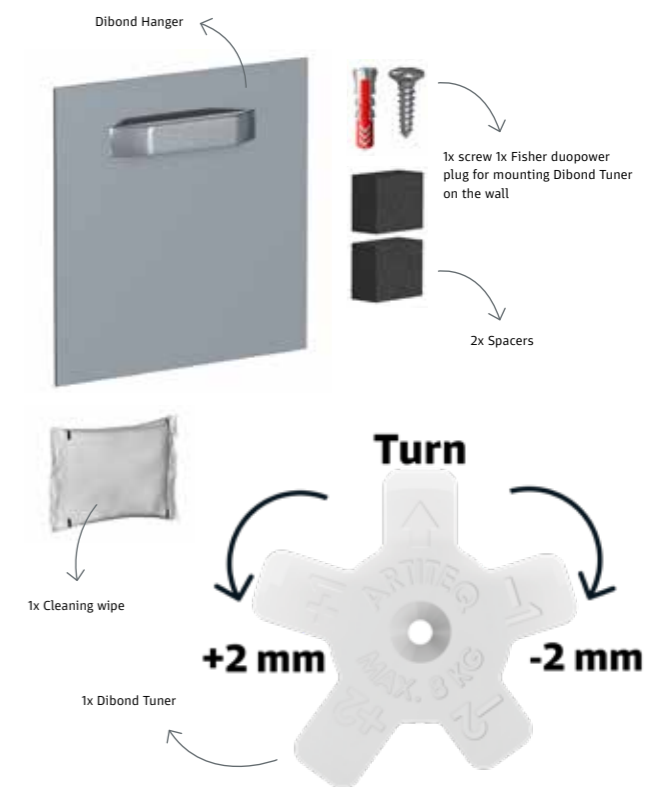

frame accessories

ACCESSORIES FOR HANGING PLATES & TILES

Tiles and plates can also be hung in combination with an Artiteq picture hanging system. Often a tile or a decorative plate does not have a hanging point on the back. With this Tile Hanger and Plate Hanger, however, it is possible to hang them on the wall.

Frames can tilt/hang forward when using a picture hanging system. To reduce the forward tilt this Tilt Reducer can be used. This can only be attached to a wooden frame.

MISCELLANEOUS



Plate Hanger White (1x)
19-28 cm (max. 1 kg)

ARTICLE NO.

807.025



Tile Hanger (1x)
32 mm (max. 200 gr)

808.130



Set Tile Hanger
(4 pieces)

4051



Set Adhesive Hanger 30 mm
For Very Light Objects
(8 pieces)

4050



DISPLAY HANGING SYSTEMS

CABLE SYSTEMS

- Optimal presentation of documents, products and services
- Simple and quick change of content
- Flexible in rail or direct mounting on wall or ceiling



display hanging systems - cable systems

DISPLAY IT LED FLEX

Make a statement with LED panels

This cable system, with LED lighting, enables documents, products and services to be displayed perfectly. It is ideal as a display system in display cabinets, where the information can stand out both day and night! The rail can be mounted to the wall or the ceiling. The adaptors can be twisted into and out of the rail in an instant, allowing flexible use of the system.

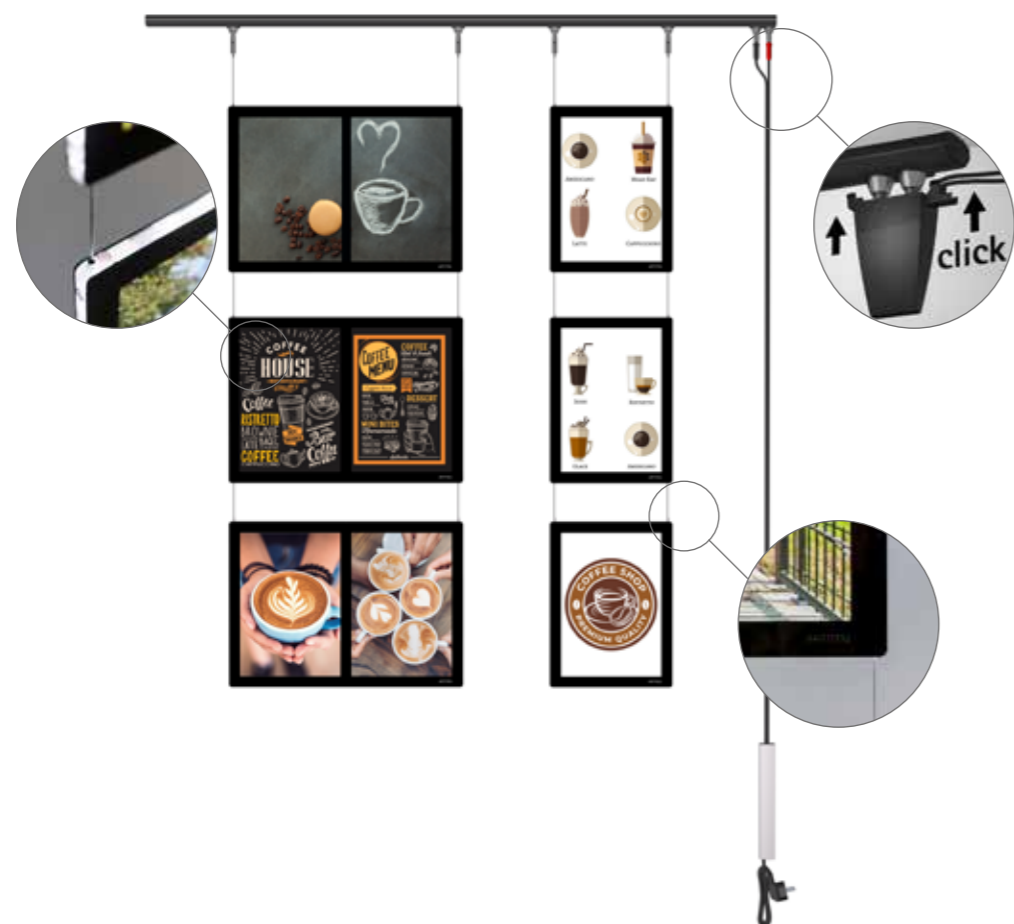

RAIL

Rail Black*	Rail Black*	Hanging Set	Power Connector Set	Rail Cover Cap Black	End cap
183 cm	300 cm	2x 300 cm		82/37 x 82 mm	
ARTICLE NO. 7720.183	7720.300	7710.010	7710.020	7740.019	7740.005

*Rail includes fastener material and end caps

display hanging systems - cable systems

DISPLAY IT LED FIXED

An eye-catcher on the wall

The Display It LED Fixed cable system is mounted to the wall or ceiling and because of the LED panels, this creates a striking display. Like the Flex version, the Display It LED Fixed can be used in display cabinets or in other places in a building.

The content of the panels can be changed in no time.



SET STEELWIRE

Hanging Set
2x 300 cm
ARTICLE NO. 7710.030

display hanging systems - cable systems
DISPLAY IT LED PANELS

The A3, A4, A2 and A1 LED panels can be used in landscape and portrait format. The 2x A4 and 3x A4 LED panels can only be used in portrait format. All LED panels are equipped with bright LED lighting. The steel cables run through an auto-grip mechanism through the LED panels, connecting these together. This gives a professional, streamlined display and allows the height of the panels to be quickly and easily adjusted. This system allows double-sided displays: translucent paper can be inserted into the front and back of the LED panels.

LED PANELS

ARTICLE NO.	7700.004	A4 (landscape & portrait)	9 watt
ARTICLE NO.	7700.003	A3 (landscape & portrait)	17 watt
ARTICLE NO.	7700.002	A2 (landscape & portrait)	22 watt
ARTICLE NO.	7700.020	2x A4 (portrait only)	17 watt
ARTICLE NO.	7700.021	3x A4 (portrait only)	24 watt

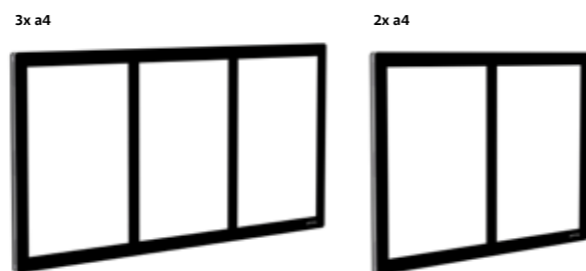

PORTRAIT

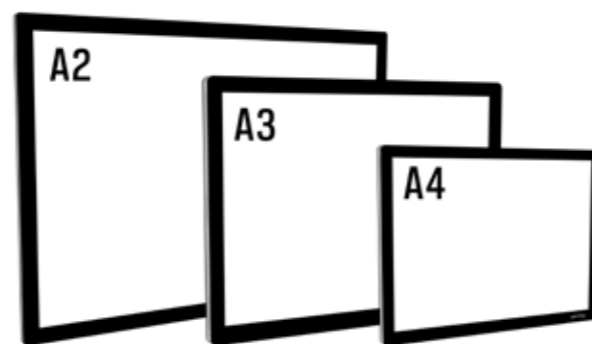

LANDSCAPE & PORTRAIT

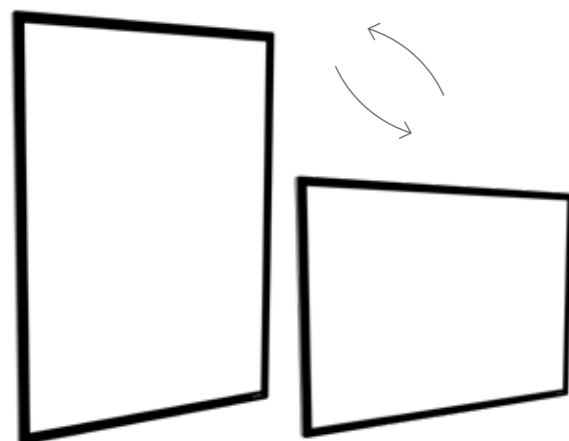

PREMIUM NEVERTEAR BACKLIT PAPER



7706.004	A4
7706.003	A3

TRANSFORMERS



ARTICLE NO.	Transformer*		Transformer Dimmable**
	60 VA	200 VA	150 va
7730.060	7730.200	7730.150CA	

* total length of cable transformer 5m
 ** only usable with app 'casambi'

LED panels with print on normal paper



LED panels with print on Xerox Nevertear Backlit Paper



possible combinations:

combination A



combination B

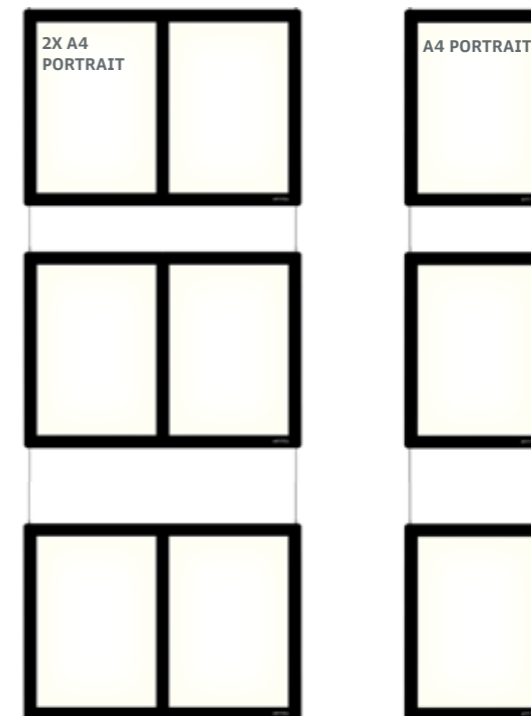

combination C



combination D



display it brochure

display hanging systems - cable systems

DISPLAY IT FIXED

Display It: professional and orderly

The Display It presentation system gives you a professional and orderly way to display your announcements or documents. The system's acrylic frames are easy to mount and adjust to the desired height. Thanks to the E-Clip for Display It, you can change the contents of the acrylic frames in seconds. The clip also makes it easy to connect the frames to one another, making both horizontal and vertical displays possible. This display system is ideal for estate agents and is often used as a 'face wall' for photos of staff displayed on the wall in hospitals and other institutions. Display It is available in Flex and Fixed mounting models. The Display It Flex version is used in combination with a hanging rail and stainless steel rods that are easy to reposition along the rail.



SET STEELWIRE

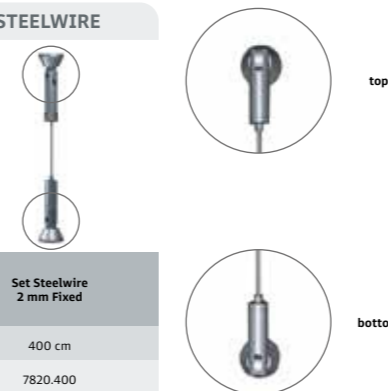

Set Steelwire 2 mm Fixed	
400 cm	
ARTICLE NO.	7820.400

CLAMPS



E-Clip	
2 mm	
ARTICLE NO.	7805.005

Clamp Single	
2-4 mm	
ARTICLE NO.	7805.001

Clamp Double	
2-4 mm	
ARTICLE NO.	7805.002

DISPLAYS

ARTICLE NO.	7803.211	2 mm A4	30 x 21 cm Landscape	
ARTICLE NO.	7803.212	2 mm A4	21 x 30 cm Portrait	
ARTICLE NO.	7803.301	2 mm A3	42 x 30 cm Landscape	
ARTICLE NO.	7803.302	2 mm A3	30 x 42 cm Portrait	
				Spring Display It Metal
				7805.006

ALL-IN SET



Box Display It E-Clip	
2x Set Steelwire 2 mm Fixed (400 cm), 20x E-Clip, 5x Display 2 mm A4 Portrait	
ARTICLE NO.	7830.401



easy to change content



installation video

display hanging systems - cable systems

DISPLAY IT FLEX

Display It: professional and orderly

The Display It presentation system gives you a professional and orderly way to display your announcements or documents. The system's acrylic frames are easy to mount and adjust to the desired height. Thanks to the E-Clip for Display It, you can change the contents of the acrylic frames in seconds. The clip also makes it easy to connect the frames to one another, making both horizontal and vertical displays possible. This display system is ideal for estate agents and is often used as a 'face wall' for photos of staff displayed on the wall in hospitals and other institutions. Display It is available in Flex and Fixed mounting models. The Display It Flex version is used in combination with a hanging rail and stainless steel rods that are easy to reposition along the rail.

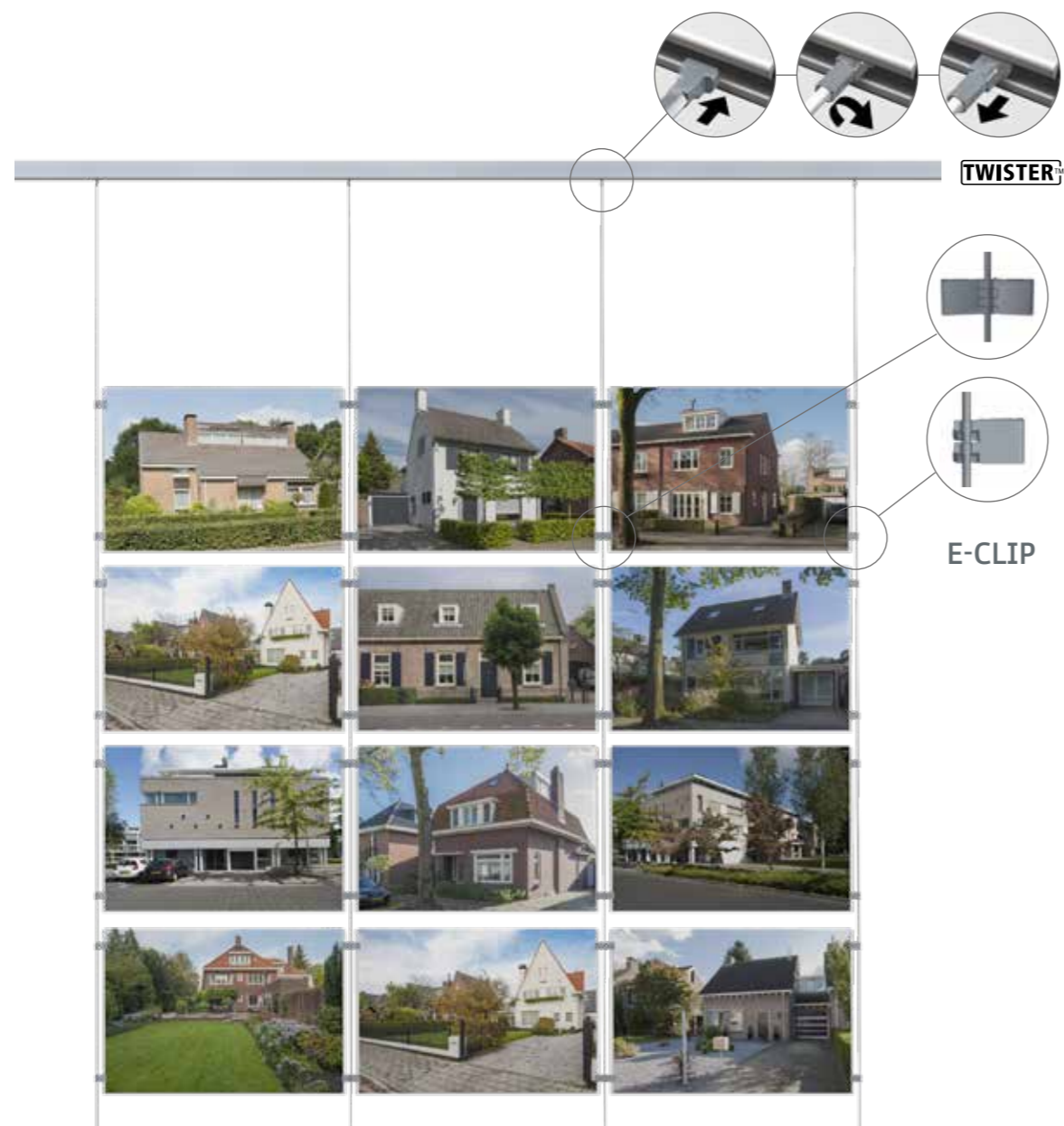

Can be used with all Artiteq Picture Hanging Systems



easy to change content



RODS

	Twister 2 mm Rod Stainless Steel	Twister 2 mm Rod White
	200 cm	200 cm
ARTICLE NO.	9.4188	9.4198

CLAMPS

	E-Clip	Clamp Single	Clamp Double
	2 mm	2.4 mm	2-4 mm
ARTICLE NO.	7805.005	7805.001	7805.002



DISPLAYS

	ARTICLE NO.	7803.211	2 mm A4	30 x 21 cm Landscape	
	ARTICLE NO.	7803.212	2 mm A4	21 x 30 cm Portrait	
	ARTICLE NO.	7803.301	2 mm A3	42 x 30 cm Landscape	
	ARTICLE NO.	7803.302	2 mm A3	30 x 42 cm Portrait	
					Spring Display It Metal
					7805.006

display hanging systems - cable systems
FLEX SCREEN HANGING SET

40 kg

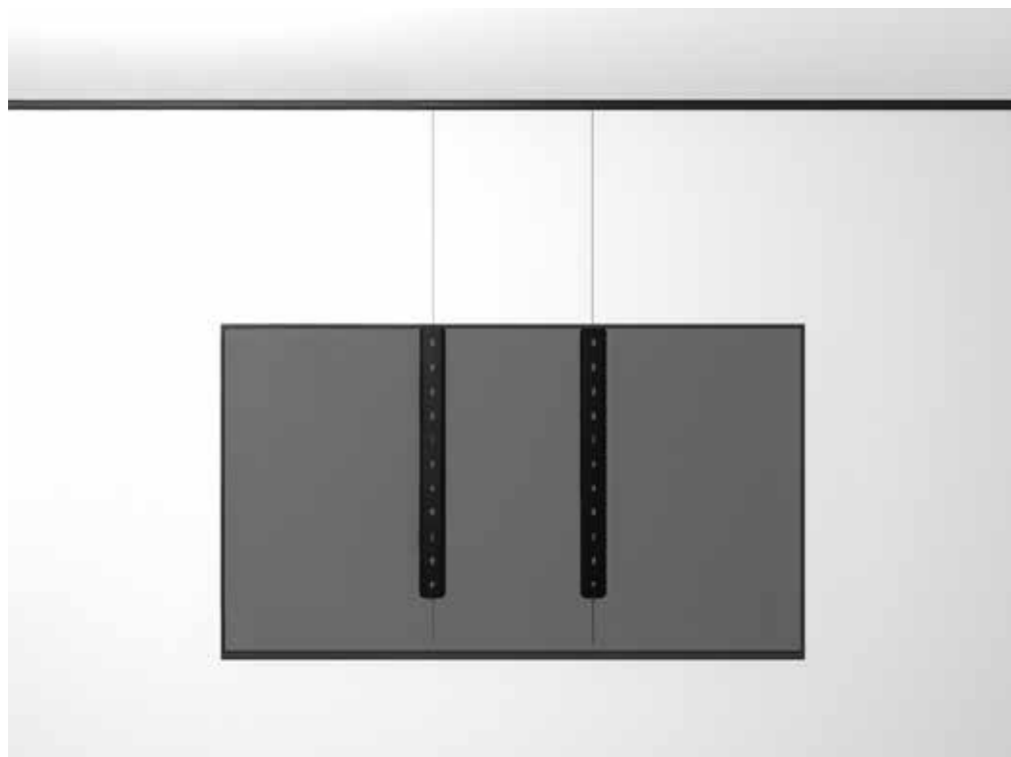

With the Flex Screen Hanging Set, you can transform any TV or monitor into a sleek and stylish wall display. No fixed wall brackets, no drilling holes, just a flexible and re-positionable TV mounting solution that allows your screen to blend seamlessly into your interior. Perfect for spaces where layouts change frequently, such as offices, schools, and modern living rooms. The set includes a universal metal frame compatible with standard VESA mounting patterns, suitable for various screen sizes.

The height-adjustable steel cables with an auto-grip mechanism let you position the screen precisely at the desired height. These cables can be mounted directly into an existing Artiteq picture rail system, making the screen horizontally adjustable without tools or wall damage. Integrated leveling feet make it easy to fine-tune the tilt and alignment of the screen for a perfectly straight setup.

FLEX SCREEN HANGING SET

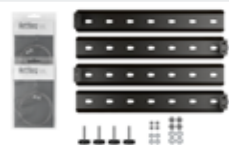

Flex Screen Hanging Set - Black

ARTICLE NO. 9.4560



- suitable for different screen sizes
- adjustable both vertically and horizontally
- align straight and stable

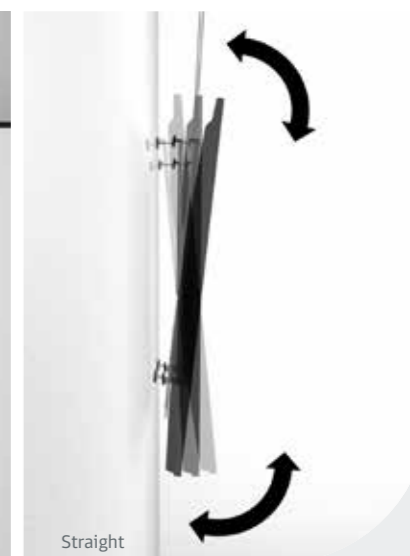
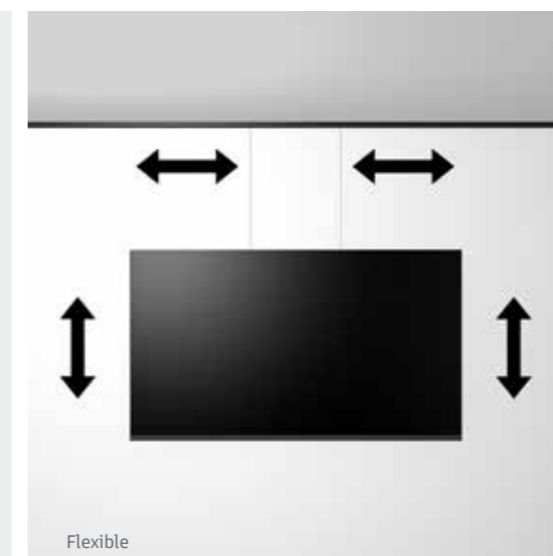
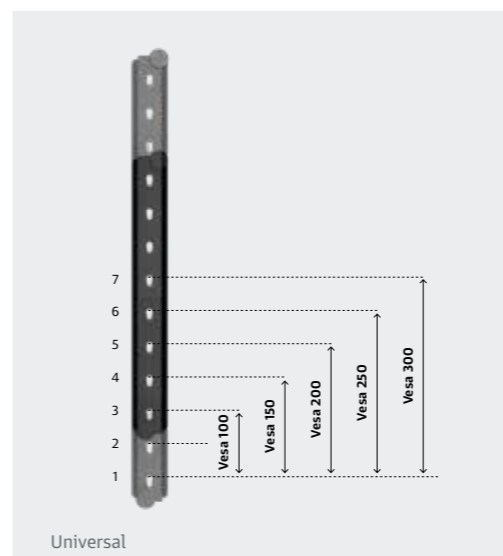

display hanging systems - cable systems
HANGING WHITEBOARDS

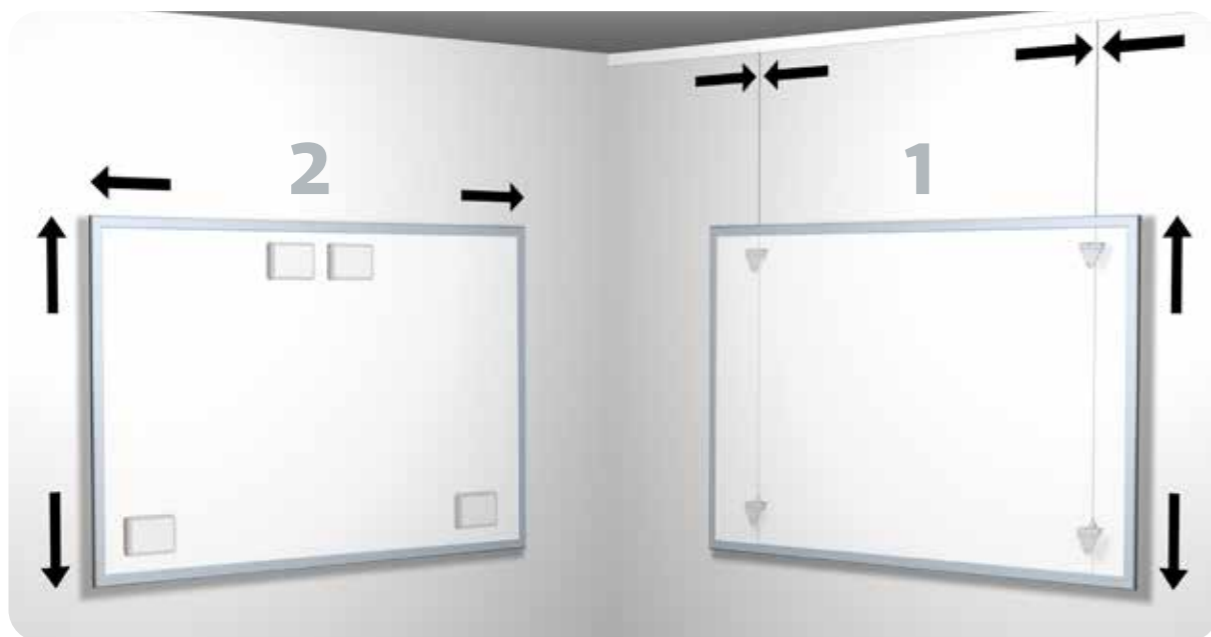

There are a variety of ways to hang a whiteboard on the wall. Hanging a whiteboard with the aid of the Whiteboardset offers the option of repositioning the whiteboard either horizontally or vertically. The Artiteq Whiteboardset has been designed to make it easy to hang a whiteboard on the wall, and offers flexibility since it may be used in combination with our hanging rails. The clamps ensure a stable mounting of the whiteboard to the wall. By combining the Whiteboardset with the hanging rail, it is extremely easy to mount the whiteboard to the precise desired spot.



display hanging systems - cable systems
**WHITEBOARDSET/
 HANGING MAGNET FOR WHITEBOARDS**

30 kg



WHITEBOARDSET

	2x	2x	12x
Whiteboardset (Hanging Wire Not Included)*	Clamp up	Clamp down	Screw 10 mm

ARTICLE NO.

9.4550

Can be used in combination with all Artiteq Picture Hanging Systems
 *To be used with Twister and Solid Slider 2 mm Steelwires (see page 66)

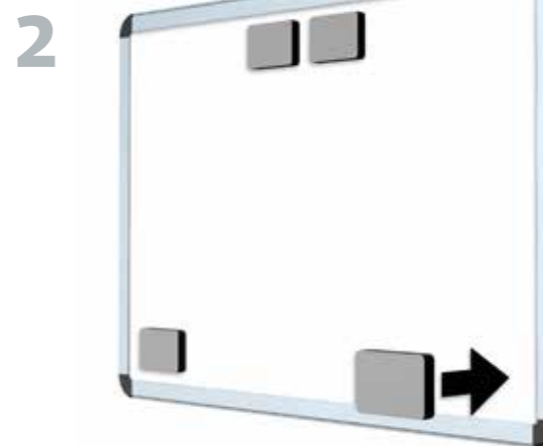

SELF-ADHESIVE HANGING MAGNET FOR WHITEBOARDS

7430.001	Self-Adhesive Hanging Magnet For Whiteboards	75 X 50 x 11 mm	max. 3 kg
----------	--	-----------------	-----------

display hanging systems - cable systems

TENSION SET WIRE



For hanging drawings, posters, crafts, garlands or decorations horizontally, this Tension wire set is the solution. The Tension wire set consists of 300 cm long black steel wire and can be combined with black paper clips in the shape of a water drop or black paper clips. The black steel wire is magnetic - choose fun magnets to hang the drawings that way. Attach the wall mount to the wall at the desired height and tension the steel wire. Perfect for the classroom or school hallways!



Tension Set:
Steelwire Black 300 cm
+ Wall Mounting 5 kg

ARTICLE NO. 7807.570



12x

Paper Clip Black

808.050



30x

Paper Clip
Water Drop Black

808.040

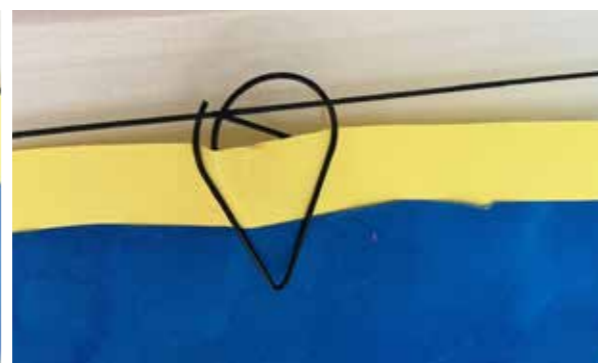

DISPLAY HANGING SYSTEMS

RAIL SYSTEMS

- Flexible presentation of drawings, documents and information
- Direct wall mounting
- Simple and quick change of drawings
- Expand with additional accessories



display hanging systems - rail systems

INFO RAIL

>80g
<2 mm

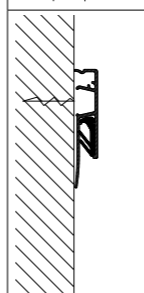
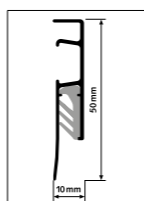

10
YEAR
WARRANTY



The Info Rail is the ideal display system for displaying cards, posters, drawings and photos on the wall. Thanks to the Info Rail, you can create a tidy, orderly display of your documents. This system means no more damaged walls from thumbtacks, tape and so on, and changing drawings or posters is fast and easy. This hanging system has become particularly indispensable in classrooms and school corridors. The Info Rail is also an ideal system for displaying or sharing information at home and the office.

Easy assembly thanks to clips

The Info Rail has been developed for hanging documents using a triple rubber clamping mechanism in the rail. Paper from 80 g to cardboard 2 mm thick can be firmly clamped into the rail. After mounting the Click & Connect clips to the wall, it's easy to attach the Info Rail to the clips. Available in different lengths, the Info Rail is easy to link to other Info Rails or shortened. Whether you want to display photos or drawings or keep recipes within easy reach, the Info Rail offers the solution.

Make the Info Rail versatile using the accessories **me-clip**, **Clip Hanger**, **Support Clip** and **Storage Clip**. See next page for more information.

INFO RAIL



05.55025	Info Rail White	25 cm	Includes Fastener Material and End Caps
05.55050	Info Rail White	50 cm	Includes Fastener Material and End Caps
05.55100	Info Rail White	100 cm	Includes Fastener Material and End Caps
05.55200	Info Rail White	200 cm	Includes Fastener Material and End Caps
05.55300	Info Rail White	300 cm	Includes Fastener Material and End Caps

05.54025	Info Rail Alu	25 cm	Includes Fastener Material and End Caps
05.54050	Info Rail Alu	50 cm	Includes Fastener Material and End Caps
05.54100	Info Rail Alu	100 cm	Includes Fastener Material and End Caps
05.54200	Info Rail Alu	200 cm	Includes Fastener Material and End Caps
05.54300	Info Rail Alu	300 cm	Includes Fastener Material and End Caps

05.56025	Info Rail Black Structure	25 cm	Includes Fastener Material and End Caps
05.56100	Info Rail Black Structure	100 cm	Includes Fastener Material and End Caps
05.56200	Info Rail Black Structure	200 cm	Includes Fastener Material and End Caps

05.55100M	Info Rail Magnetic White	100 cm	Includes Fastener Material, End Caps and 4 Mouse Magnets
05.55200M	Info Rail Magnetic White	200 cm	Includes Fastener Material, End Caps and 4 Mouse Magnets

05.47160	End Cap Info Rail White (L&R)
05.47150	End Cap Info Rail Grey (L&R)
05.47170	End Cap Info Rail Black (L&R)



Artiteq Info Rail in education

INFO RAIL *me* ALL-IN SET



05.53100	Info Rail <i>me</i> White	100 cm	Includes 4 x <i>me</i> -clip	Includes Fastener Material and End Caps
05.53200	Info Rail <i>me</i> White	200 cm	Includes 8 x <i>me</i> -clip	Includes Fastener Material and End Caps



display hanging systems - rail systems
me-CLIP AND CLIP HANGER



me-CLIP



05.47100	me-clip black	44,5(h) x 74(b) x 13(d) mm
05.47110	me-clip white	44,5(h) x 74(b) x 13(d) mm



installation video

CLIP HANGER 1 kg



05.47200	Clip Hanger Black	59(h) X 8,5(b) X 23(D) mm
05.47210	Clip Hanger White	59(h) X 8,5(b) X 23(D) mm



installation video

me-clip - personal and organised

The *me-clip* adds an extra personal and beautifully designed element to the Info Rail system. A name can be added to the contents of the clip. A great solution for the perfect presentation and communication tool. The clip is always adaptable and always keeps its 100% quality appearance, no matter how often the clip is used. It's handy, and directly and rapidly adaptable thanks to Info Rail's smart, flexible properties.

Clip Hanger

With a simple click, the Clip Hanger is attached to the Info Rail, allowing a craft project to be hung up. In combination with the *me-clip*, art creations can be presented in a fun and personal manner.



display hanging systems - rail systems
STORAGE CLIP AND SUPPORT CLIP

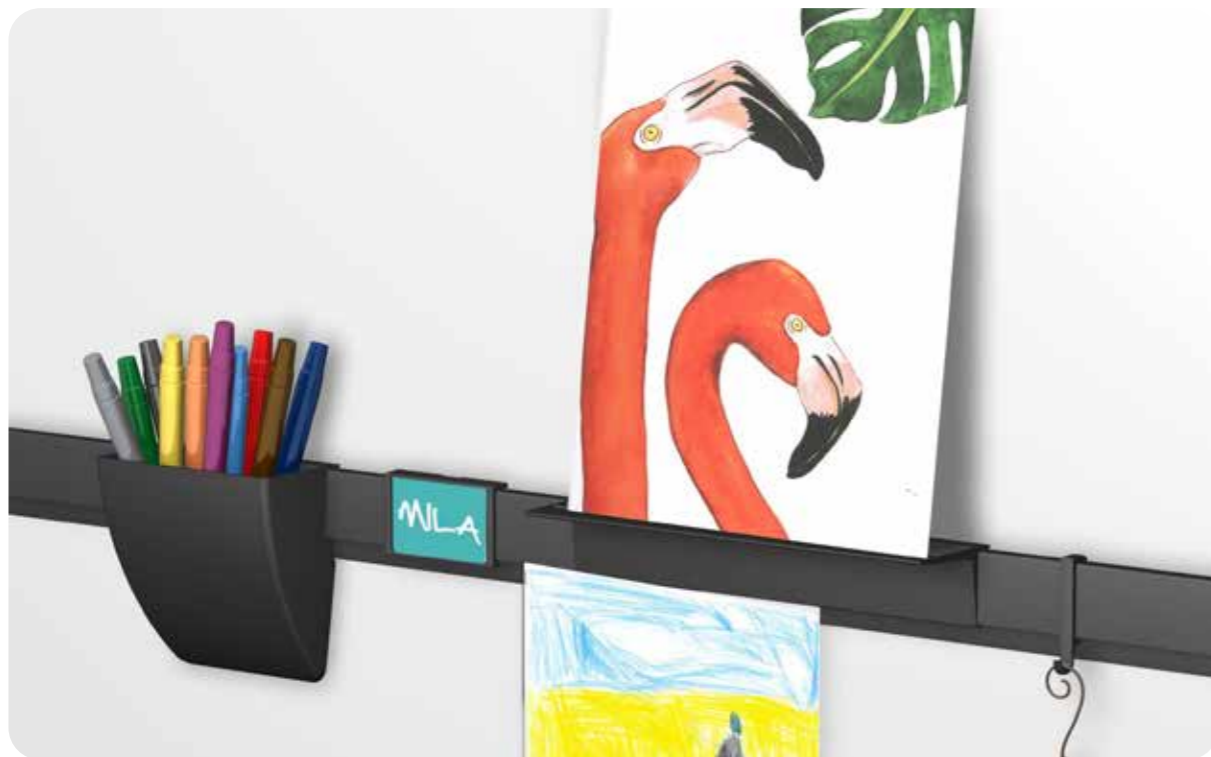

Two useful additional accessories

The Support Clip and Storage Clip are two useful additional accessories for on the Info Rail and Info Rail Magnetic. Both accessories add an extra dimension and element to the Info Rail concept. With the Support Clip, you can easily present small crafts, greeting cards, small frames or paintings on canvas. The Support Clip is simply attached to the rail at any desired location. On the 6 cm wide and 25 cm long surface, changing small crafts, greeting cards or small frames is easy and quick. The subtle grooves ensure that the presented products remain securely in place. The Storage Clip is a practical additional storage compartment for pens, markers or other small items. Just like the Support Clip, the Storage Clip is simply attached to the rail at any desired location. The stylish round shape has a timeless appeal. Both accessories are available in black and white.

STORAGE CLIP



05.47400	Storage Clip Black 1 kg	60 (h) x 126 (b) x 123 (d) mm
05.47410	Storage Clip White 1 kg	60 (h) x 126 (b) x 123 (d) mm



SUPPORT CLIP



05.47300	Support Clip Black 1 kg	60 (h) x 250 (b) x 42 (d) mm
05.47310	Support Clip White 1 kg	60 (h) x 250 (b) x 42 (d) mm



display hanging systems - rail systems
INFO RAIL+

>80g
<2 mm

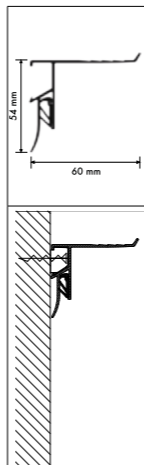

5
kg p/m

10
YEAR
WARRANTY

Versatile presentation system on the wall

With Info Rail + you can create a versatile presentation system on the wall. Photos, drawings or recipes are easily clamped into the rail, as you may already be used to from our Info Rail. On top is a 6 cm wide area where small photo frames, canvas paintings, greeting cards or other small crafts can be presented. An ideal, flexible and versatile presentation system where walls do not need to be damaged and the changing of drawings, posters or frames is quick and easy. Paper from 80 g up to cardboard with a thickness of 2 mm are firmly clamped in the rail thanks to a double plastic clamping mechanism. The top surface of 6 cm has some subtle grooves to present a card or a list stably.



INFO RAIL +

	05.57200	Info Rail + white	200 cm	Includes Fastener Material and End Caps
	05.47180	End Cap Info Rail + White (L&R)		



display hanging systems - rail systems

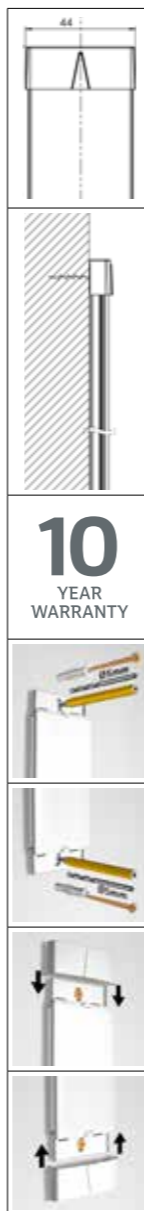

CARD RAIL



10
YEAR
WARRANTY



CARD RAIL

	1x		4x
Card Rail White (RAL 9016) Fastener Material and End Caps Included		Mouse Magnets White	
ARTICLE NO. 7220.110			

EXTRA / OPTIONAL

	7430.010	Mouse Magnets Colour
	7430.020	Mouse Magnets White

display hanging systems - miscellaneous

POSTER SYSTEMS



POSTER SNAP

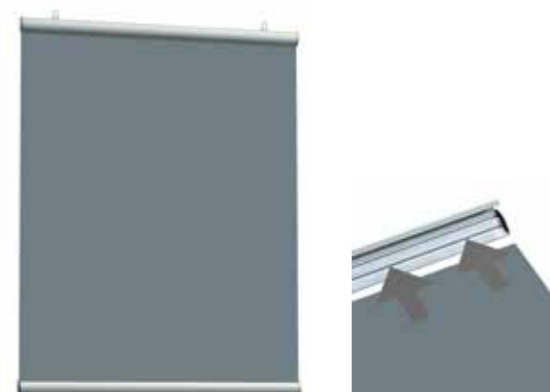

7350.050	Poster snap 50 cm
7350.070	Poster snap 70 cm
7350.100	Poster snap 100 cm
7350.120	Poster snap 120 cm

SIGN HANGING SYSTEMS

- Signage inside building
- Hanging acoustic panels from the ceiling
- Possibilities for ceilings and recessed ceilings
- Various combinations possible



sign hanging systems

XPO RAIL LOW HANGING

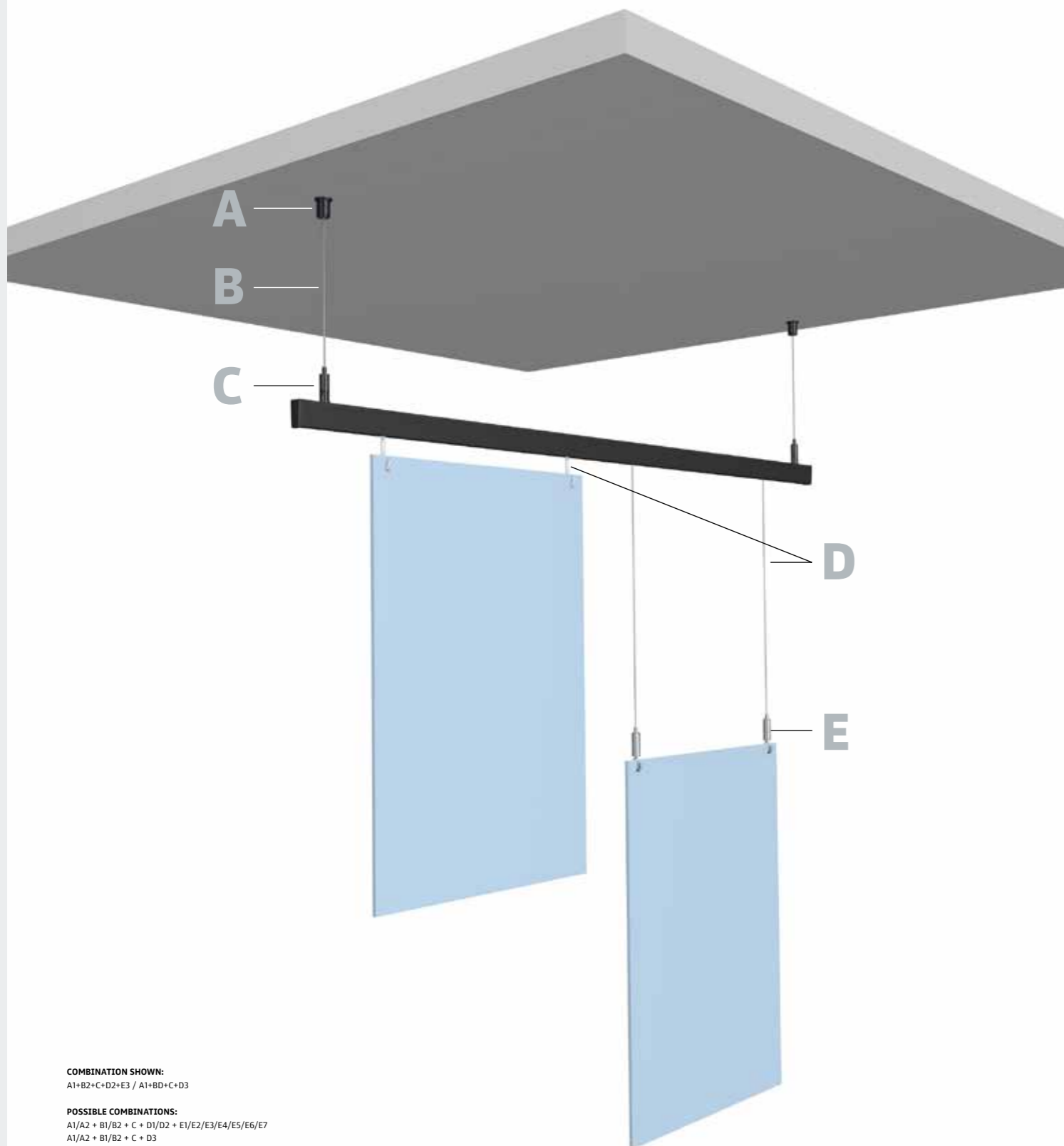

COMBINATION SHOWN:
A1+B2+C+D2+E3 / A1+BD+C+D3

POSSIBLE COMBINATIONS:
A1/A2 + B1/B2 + C + D1/D2 + E1/E2/E3/E4/E5/E6/E7
A1/A2 + B1/B2 + C + D3
A3 + B3/B4 + C + D1/D2 + E1/E2/E3/E4/E5/E6/E7
A3 + B3/B4 + C + D3

A1			A2			A3
Ceiling Bracket Black CO1BL	Fischer Duopower 5x25 5 mm	Screw	Ceiling Bracket Nickel CO1NI	Fischer Duopower 5x25 5 mm	Screw	Ceiling Suspension Auto Grip 1,2 mm CS01NI
7807.100	9.4934	9.4945	7807.110	9.4934	9.4945	7807.140

B1	B2	B3	B4
Steelwire + Slider 1,2 mm 300 cm Black	Steelwire + Slider 1,2 mm 300 cm Nickel	Steelwire 7 x 7 1,2 mm 10 m*	Steelwire Black 7 x 7 1,2 mm 3 m*
7807.200	7807.210	7807.350	7807.360

C		
Suspension Bracket XPO Rail 1,2 mm	XPO Rail 200 cm Black	End Cap XPO Rail Black
7807.060	05.15201	05.15030

D1	D2	D3
Steelwire + Slider 1,2 mm 300 cm Black	Steelwire + Slider 1,2 mm 300 cm Nickel	Twister Hook
7807.200	7807.210	9.4510

E1	E3	E4	E5	E6	E7
Steelwire Hook Auto Grip 1,2 mm ST01BL	Steelwire Hook Auto Grip 1,2 mm ST02NI	Steelwire Hook Auto Grip 1,2 mm ST03NI	Steelwire Clamphook Auto Grip 1,2 mm STC01NI	Steelwire Hook Auto Grip 1,2 mm STD01NI Nickel	Steelwire Hook Auto Grip 1,2 mm STD01BL Black
7807.010	7807.030	7807.040	7807.050	7807.080	7807.070

* Cable cutter 7807.900 available for use with steelwire 7 x 7 1.2 mm.

sign hanging systems
XPO RAIL

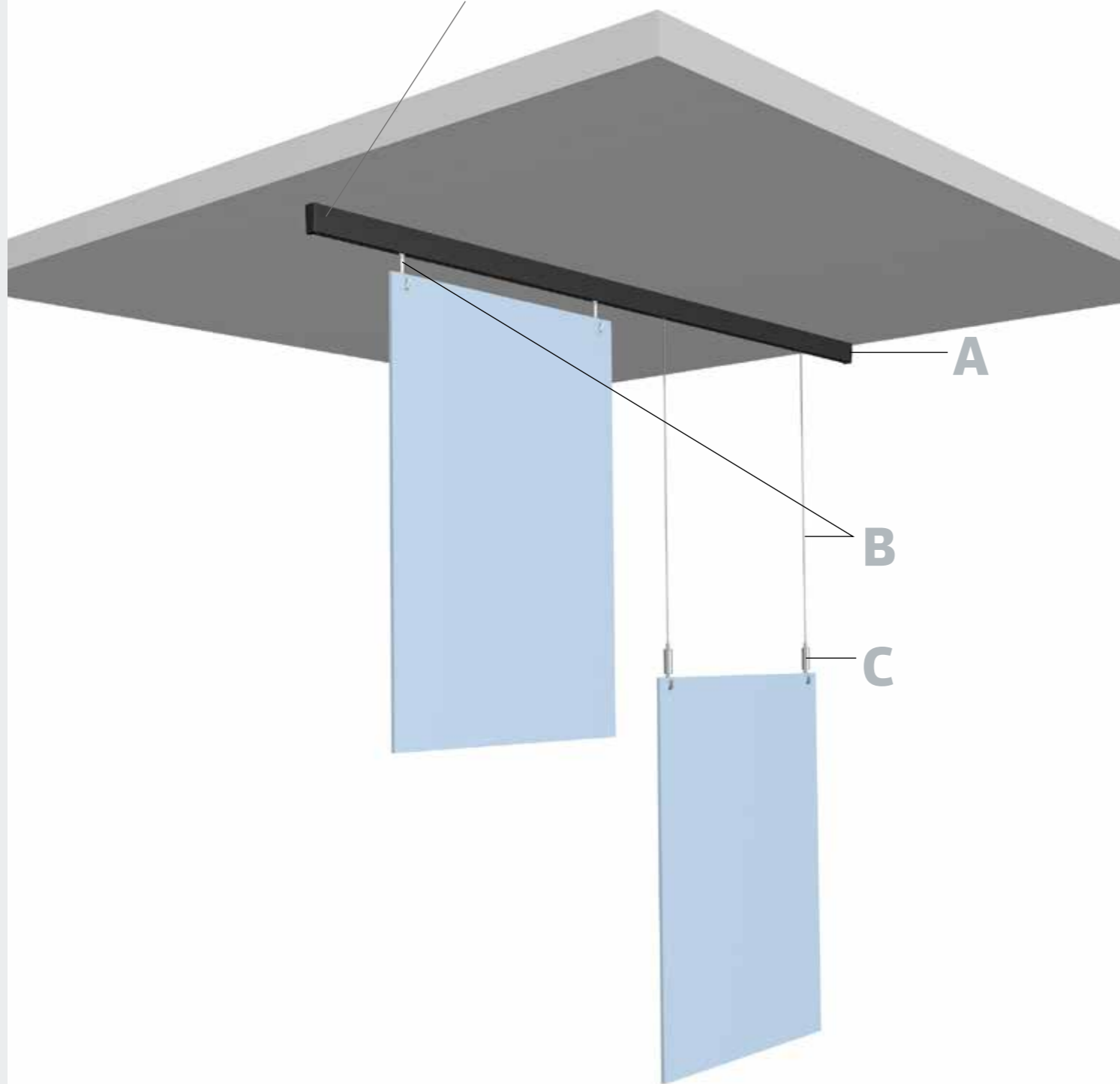
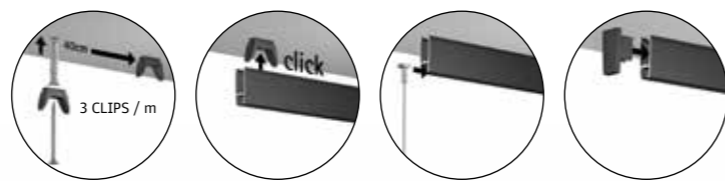

COMBINATION SHOWN:
A + B3
A + B2 + C3

POSSIBLE COMBINATIONS:
A + B1/B2 + C1/C2/C3/C4/C5/C6/C7
A + B3

A	
XPO Rail 200 cm Black	XPO Rail 200 cm White Primer
05.15201	05.15200

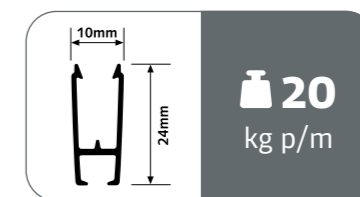

A						
End Cap XPO Rail Black	End Cap XPO Rail White	Clip Click&Connect XPO Rail	Fischer Duopower 5x25 5 mm	Screw 3,5 x 40 mm	Fastener Kit XPO Rail White 200 cm	Fastener Kit XPO Rail Black/Alu 200 cm
05.15030	05.15020	05.15010	9.4934	9.4945	5092	5093

B1	B2	B3
Steelwire + Slider 1,2 mm 300 cm Black	Steelwire + Slider 1,2 mm 300 cm Nickel	Twister Hook
7807.200	7807.210	9.4510

C1	C3	C4	C5	C6	C7
Steelwire Hook Auto Grip 1,2 mm STD01BL	Steelwire Hook Auto Grip 1,2 mm STO2NI	Steelwire Hook Auto Grip 1,2 mm STO3NI	Steelwire Clamphook Auto Grip 1,2 mm STC0INI	Steelwire Hook Auto Grip 1,2 mm STD0INI Nickel	Steelwire Hook Auto Grip 1,2 mm STD01BL Black
7807.010	7807.030	7807.040	7807.050	7807.080	7807.070

CONTENT FASTENER KIT



installation
video



		Quantity 200 cm
05.15010	Clip XPO Rail	6x
9.4934	Plug Fischer 5 mm	6x
9.4945	Screw For Plug Fischer 5 mm	6x
05.15020 / 05.15030	End Cap Xpo Rail White / Black	2x
2639	Instruction	1x

sign hanging systems
CEILING

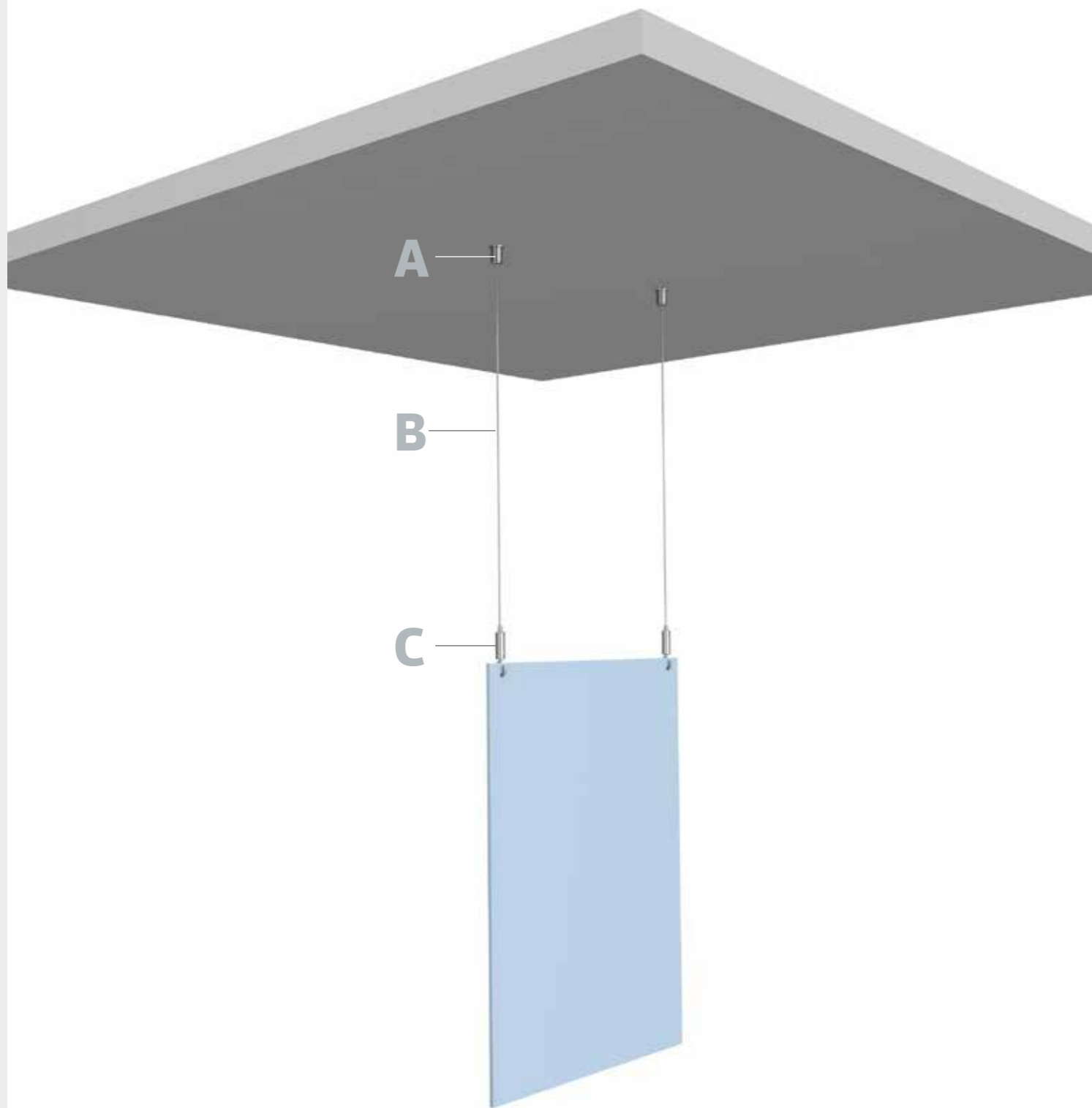

COMBINATION SHOWN:
A2 + B2 + C3

POSSIBLE COMBINATIONS:
A1/A2 + B1/B2 + C1/C2/C3/C4/C5/C6/C7
A3 + B3/B4 + C1/C2/C3/C4/C5/C6/C7

A			A2			A3
Ceiling Bracket Black CO1BL	Fischer Duopower 5x25 5 mm	Screw 3,5 x 40 mm	Ceiling Bracket Nickel CO1NI	Fischer Duopower 5x25 5 mm	Screw 3,5 x 40 mm	Ceiling Suspension Auto Grip 1,2 mm CS01NI
7807.100	9.4934	9.4945	7807.110	9.4934	9.4945	7807.140

B1	B2	B3	B4
Steelwire + Slider 1,2 mm 300 cm Black	Steelwire + Slider 1,2 mm 300 cm Nickel	Steelwire 7 x 7 1,2 mm 10 m*	Steelwire Black 7 x 7 1,2 mm 3m*
7807.200	7807.210	7807.350	7807.360

C1	C3	C4	C5	C6	C7
Steelwire Hook Auto Grip 1,2 mm ST01BL	Steelwire Hook Auto Grip 1,2 mm ST02NI	Steelwire Hook Auto Grip 1,2 mm ST03NI	Steelwire Clamphook Auto Grip 1,2 mm STC01NI	Steelwire Hook Auto Grip 1,2 mm STD01NI Nickel	Steelwire Hook Auto Grip 1,2mm Std01bl Black
7807.010	7807.030	7807.040	7807.050	7807.080	7807.070

D
COMPLETE SET
Set Ceiling 2x Steelwire 1,2 mm 300 cm + 2x Ceiling Bracket Nickel + 2x Steelwire Hook
7807.520

* Cable cutter 7807.900 available for use with steelwire 7 x 7 1.2 mm

sign hanging systems

CEILING SLANTED WALLS

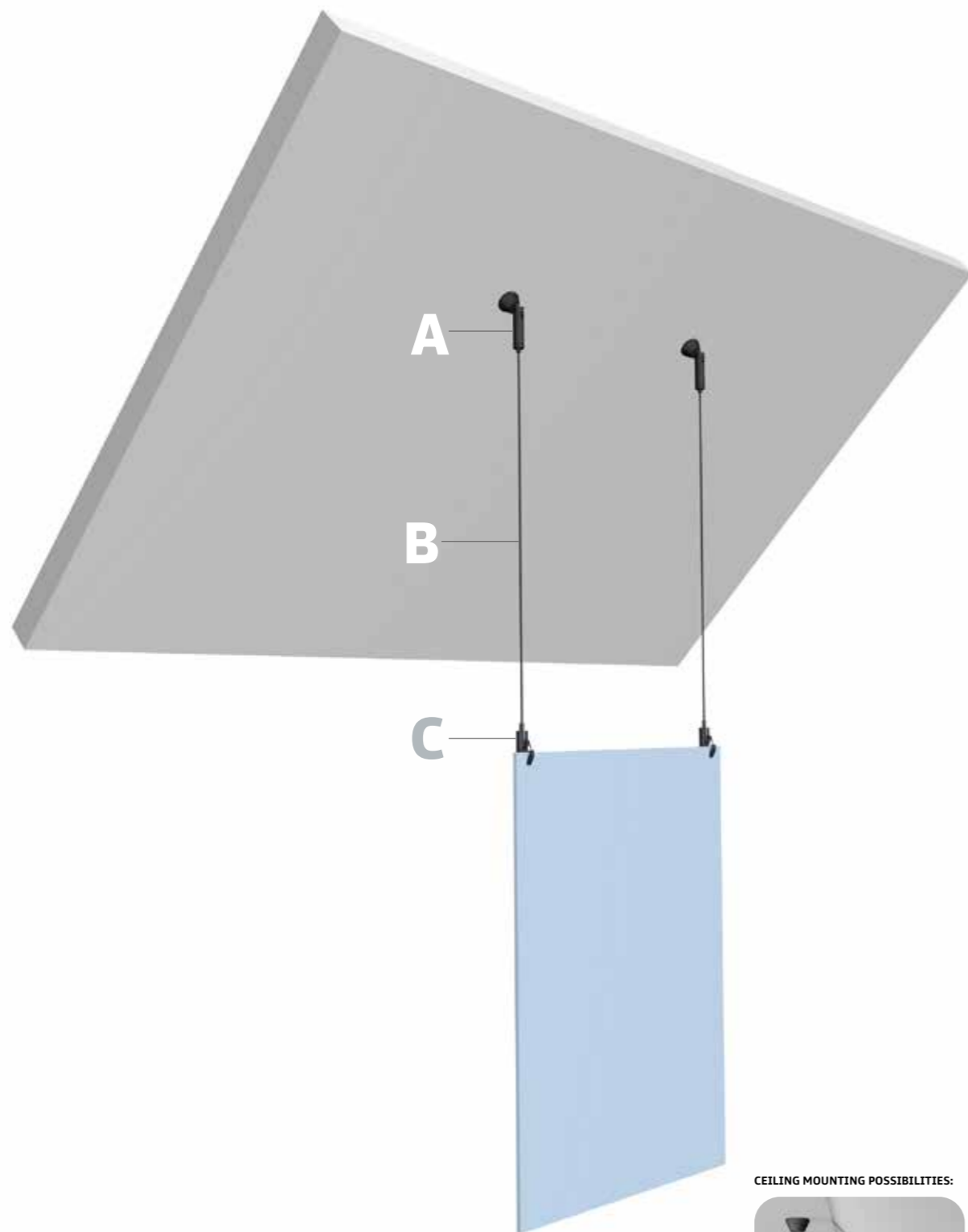

CEILING MOUNTING POSSIBILITIES:



COMBINATION SHOWN:
A2 + B2 + C1

POSSIBLE COMBINATIONS:
A1/A2 + B1/B2 + C1/C2/C3/C4/C5/C6/C7

A

A1



Ceiling Bracket Auto Grip
DO1NI Silver

7807.160

A2



Ceiling Bracket Auto Grip
DO1BL Black

7807.150

B

B1



Steelwire 7 x 7
1,2 mm 10 m*

7807.350

B2



Steelwire Black 7 x 7
1,2 mm 3 m*

7807.360

C

C1 C3 C4 C5 C6 C7



Steelwire Hook
Auto Grip
1,2 mm ST01BL

7807.010



Steelwire Hook
Auto Grip
1,2 mm ST02NI

7807.030



Steelwire Hook
Auto Grip
1,2 mm ST03NI

7807.040



Steelwire Clamphook
Auto Grip
1,2 mm STC0INI

7807.050



Steelwire Hook
Auto Grip
1,2 mm STD0INI Nickel

7807.080



Steelwire Hook
Auto Grip
1,2 mm STD01BL Black

7807.070

* Cable cutter 7807.900 available for use with steelwire 7 x 7 1,2 mm

sign hanging systems
RECESSED CEILING

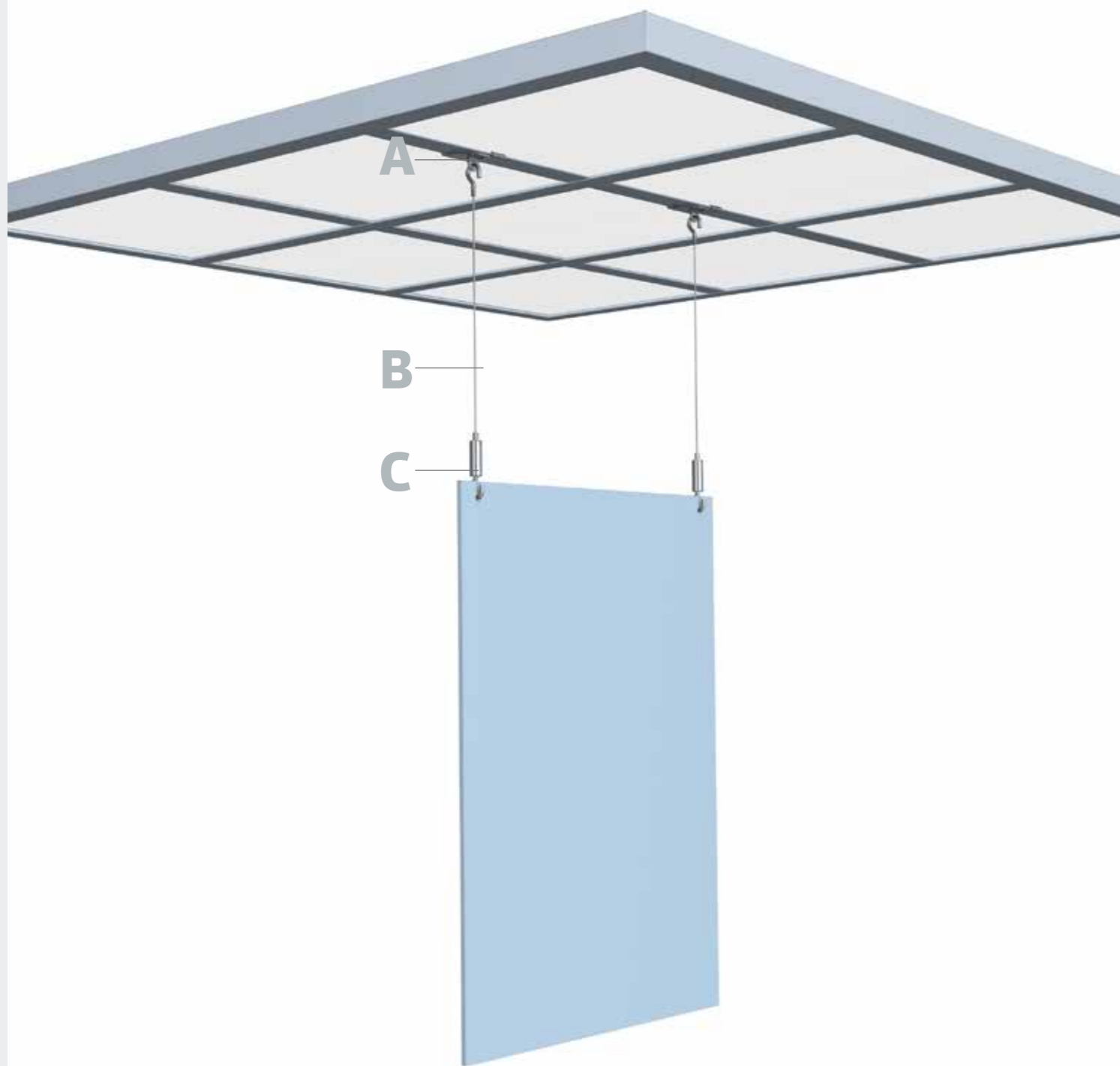

COMBINATION SHOWN:
A1 + B1 + C3

POSSIBLE COMBINATIONS:
A1 + B1 + C1/C2/C3/C4/C5/C6/C7
A2 + B2/B3 + C1/C2/C3/C4/C5/C6/C7

A		A1		A2		A3							
		Recessed Ceiling Clip 24 mm		Recessed Ceiling Clip 24 mm + Suspension Auto Grip 1,2 mm		Recessed Ceiling Clip Black 24 mm							
		7807.120		7807.130		7807.121							
B		B1		B2		B3							
		Steelwire + Hook 1,2 mm 300 cm		Steelwire 7 x 7 1,2 mm 10 m*		Steelwire Black 7 x 7 1,2 mm 3 m*							
		7807.310		7807.350		7807.360							
C		C1		C3		C4		C5		C6		C7	
		Steelwire Hook Auto Grip 1,2 mm ST01BL		Steelwire Hook Auto Grip 1,2 mm ST02NI		Steelwire Hook Auto Grip 1,2 mm ST03NI		Steelwire Clamphook Auto Grip 1,2 mm STC0INI		Steelwire Hook Auto Grip 1,2 mm STD0INI Nickel		Steelwire Hook Auto Grip 1,2 mm STD0IBL Black	
		7807.010		7807.030		7807.040		7807.050		7807.080		7807.070	
D		COMPLETE SET											
		Set Recessed Ceiling 2x Steelwire 1,2 mm 300 cm + 2x Recessed Ceiling Clip + 2x Steelwire Hook											
		7807.510											

* Cable cutter 7807.900 available for use with steelwire 7 x 7 1,2 mm

sign hanging systems

RECESSED CEILING CLIP

1 kg



A

A1



Recessed Ceiling Clip Eco White (max. 1 kg)

7807125

A2



Recessed Ceiling Clip Eco Black (max. 1 kg)

7807126

B

B1



Twister 1 mm Perlon

30.21150	150 cm
30.21200	200 cm
30.21300	300 cm

B2



Twister 2 mm Perlon

09.23100	100 cm
09.23150	150 cm
09.23200	200 cm
09.23250	250 cm
09.23300	300 cm
09.23500	500 cm

B3



Slider Economy 2 mm Perlon

9.4424	100 cm
9.4425	150 cm
9.4426	200 cm
9.4427	250 cm
9.4428	300 cm

B4



Perlonwire 2 mm Spool

9.4404	100 cm
9.44215	500 cm

Wire Clamp 2 mm Alu

9.4431

C

C1



30.41100

Auto Grip

C2



9.4205

Mini Hook

COMBINATION SHOWN:
A1 + B2 + C2

POSSIBLE COMBINATIONS:
A1 + B3 + C2
A1 + B2 + C2
A1 + B1 + C1
A1 + B4 + C2

For more hooks see page 70.

sign hanging systems

DROP CEILING HANGER

4 kg



A



Drop Ceiling Hanger (max. 4 kg)

7807135

B



Slider Economy 2 mm Perlon

9.4424	100 cm
9.4425	150 cm
9.4426	200 cm
9.4427	250 cm
9.4428	300 cm

C



9.4205

Mini Hook

D





9.6957

Set Drop Ceiling Clip +
Slider Economy 150 cm + hook 4 kg

ONLY POSSIBLE COMBINATION:
A1 + B1 + C1

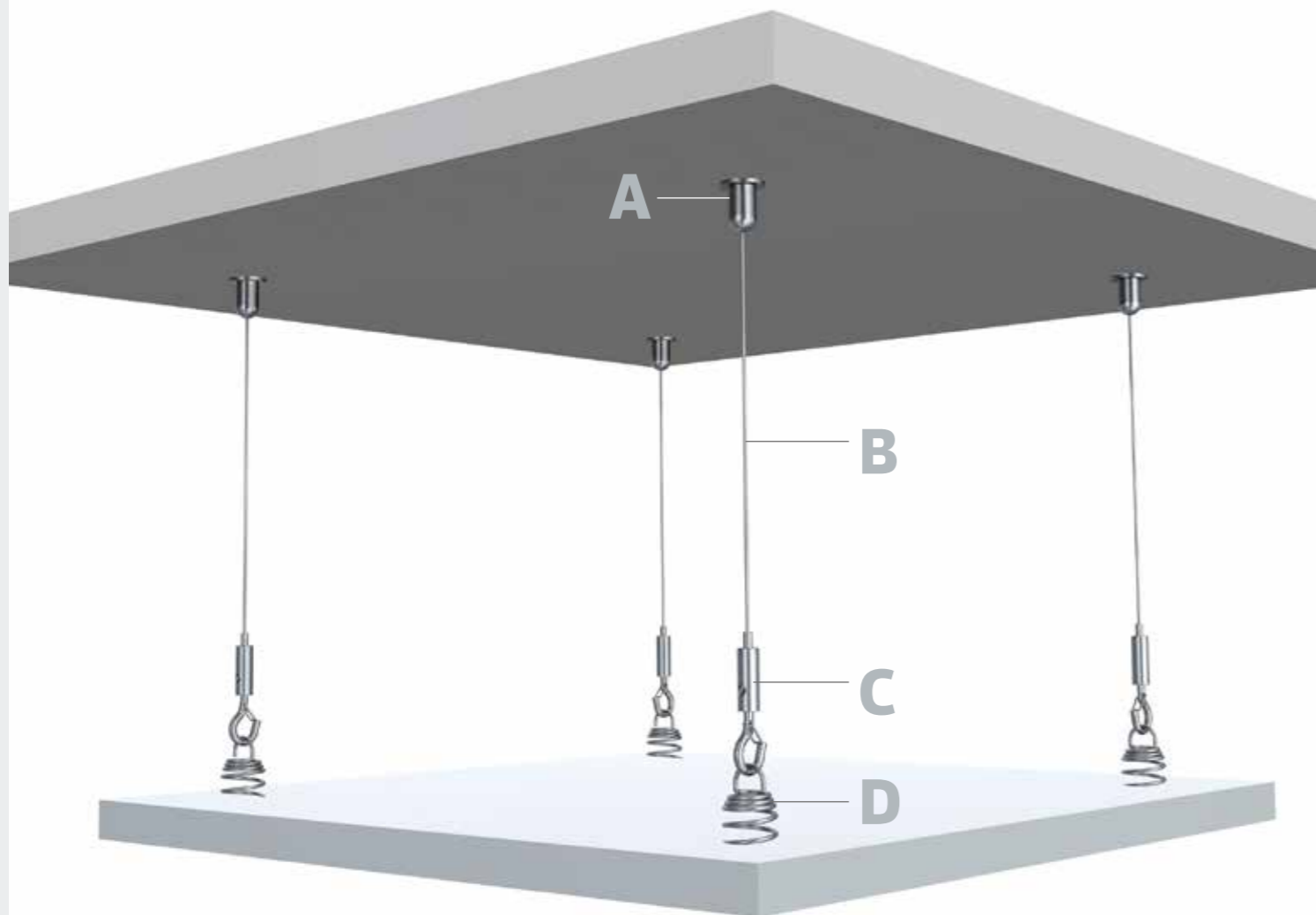
sign hanging systems
CEILING ACOUSTIC



A			A2			A3
						
Ceiling Bracket Black C01BL	Fischer Duopower 5x25 5 mm	Screw 3,5 x 40 mm	Ceiling Bracket Nickel C01NI	Fischer Duopower 5x25 5 mm	Screw 3,5 x 40 mm	Ceiling Suspension Auto Grip 1,2 mm CS01NI
7807.100	9.4934	9.4945	7807.110	9.4934	9.4945	7807.140

B1	B2	B3	B4
			
Steelwire + Slider 1,2 mm 300 cm Black	Steelwire + Slider 1,2 mm 300 cm Nickel	Steelwire 7 x 7 1,2 mm 10 m*	Steelwire Black 7 x 7 1,2 mm 3 m*
7807.200	7807.210	7807.350	7807.360

C1	C3	C4
		
Steelwire Hook Auto Grip 1,2 mm ST01BL	Steelwire Hook Auto Grip 1,2 mm ST02NI	Steelwire Hook Auto Grip 1,2 mm ST03NI
7807.010	7807.030	7807.040

D

Acoustic Spring 01-NI
7807.400

* Cable cutter 7807.900 available for use with steelwire 7 x 7 1.2 mm

COMBINATION SHOWN:
A2 + B2 + C4 + D

POSSIBLE COMBINATIONS:
A1/A2 + B1/B2 + C1/C2/C3/C4 + D
A3 + B3/B4 + C1/C2/C3/C4 + D

sign hanging systems
LOOP HANGER

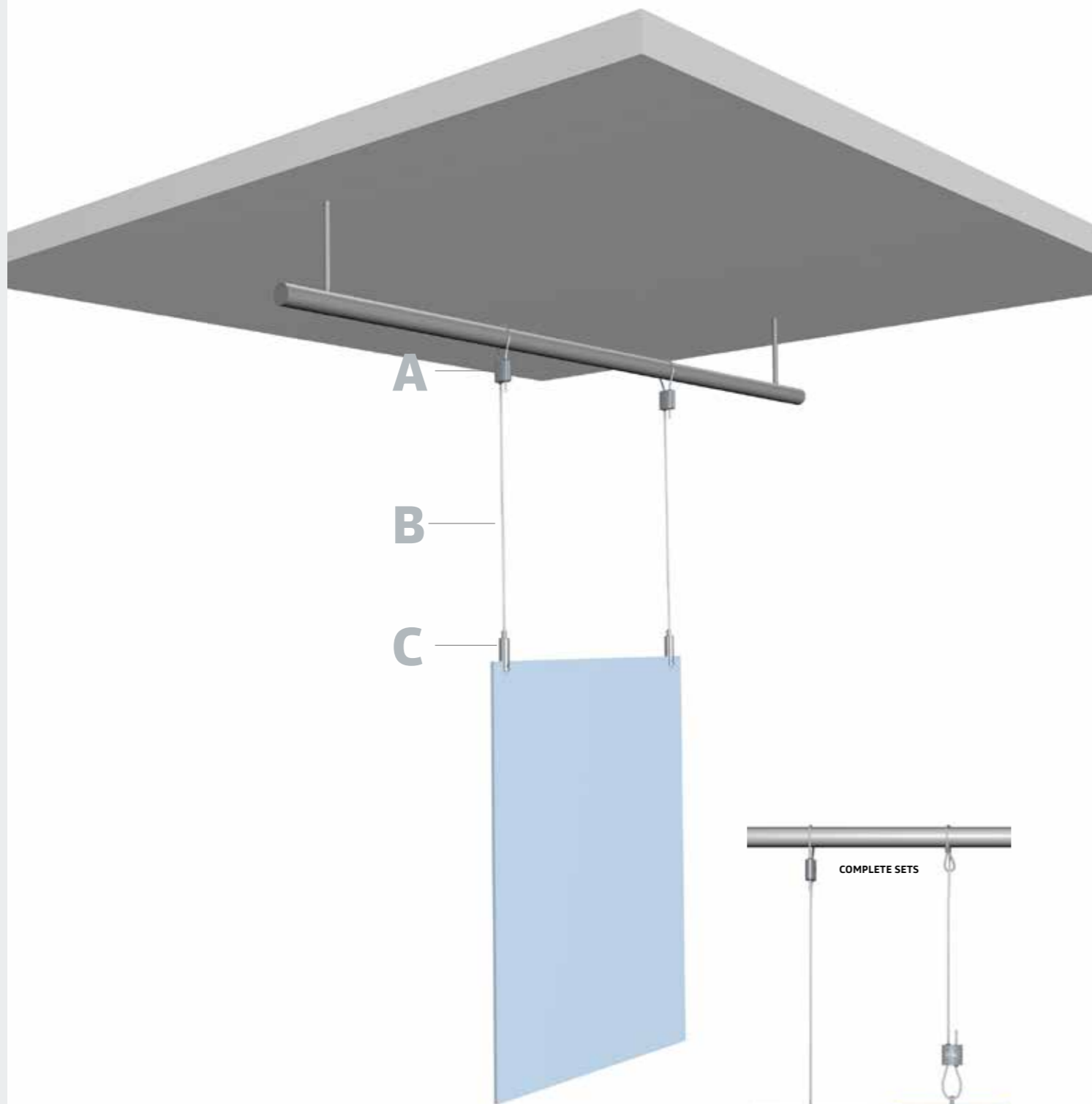

1

2

COMBINATION SHOWN:
A + B1 + C5

POSSIBLE COMBINATIONS:
A + B1/B2 + C1/C2/C3/C4/C5/C6/C7

A					
Loop Hanger 1,0 - 1,5 mm					
7805.052					
B1		B2			
Steelwire 7 x 7 1,2 mm 10 m*		Steelwire Black 7 x 7 1,2 mm 3 m*			
7807.350		7807.360			
C					
C1	C3	C4	C5	C6	C7
Steelwire Hook Auto Grip 1,2 mm ST01BL	Steelwire Hook Auto Grip 1,2 mm ST02NI	Steelwire Hook Auto Grip 1,2 mm ST03NI	Steelwire Clamphook Auto Grip 1,2 mm STC01NI	Steelwire Hook Auto Grip 1,2 mm STD01NI Nickel	Steelwire Hook Auto Grip 1,2 mm STD01BL Black
7807.010	7807.030	7807.040	7807.050	7807.080	7807.070
D COMPLETE SET 1			D COMPLETE SET 2		
Set Loop Hanger Steelwire 1,2 mm 300 cm + Hook			Set Loop Hanger Steelwire 1,2 mm 300 cm + Loop		
7840.300			7840.310		

* Cable cutter 7807.900 available for use with steelwire 7 x 7 1,2 mm

sign hanging systems
SIGN HANGING SYSTEMS

Artiteq has selected the Fischer UX 5x30 R plug to be used in combination with its hanging systems. The Fischer UX 5x30 R plug can be used in different kinds of materials, such as concrete, stone and plasterboard. Depending on the material, the plug can support a maximum load of **30 kg**. The drill used with the plug must have a diameter of 5 mm. The plug is 30 mm in length. The screw used with the plug is 38 mm long and has a diameter of 3.5 mm (to be used in combination with a PZ2 bit).

To determine the maximum load of a signing hanging system, it must be known what type of mounting materials will be used and what surface (i.e. type of material) these will be attached to. The components of the signing hanging system all have a maximum bearing capacity. This is the maximum bearing capacity for the component itself and not the maximum bearing capacity that must be taken into account for the system as a whole. For the whole system, the load capacity that is recommended for the mounting material in combination with the respective base material, takes precedence.

For every signing hanging system, the weight that you wish to hang must be balanced against the maximum load capacity of the mounting material. If systems are hung from other hanging components, such as recessed ceilings, you have to know the maximum load of this hanging component before fitting our systems. The tables below show the maximum load capacity for the Fischer plug in combination with different materials and the maximum bearing capacity for each component for the different signing hanging systems.



Duopower		5 x 25	
Highest recommended loads ¹ for a single anchor. The given loads are valid for wood screws with the specified diameter.			
Wood screw diameter		[mm]	4
Min. edge distance concrete	C _{min}	[mm]	30
RECOMMENDED LOADS IN THE RESPECTIVE BASE MATERIAL F_{rec} ²⁾			
Concrete	≥ C20/25	[kN]	0,40
Solid brick	≥ Mz 12	[kN]	0,30
Solid sand-lime brick	≥ KS 12	[kN]	0,50
Aerated concrete	≥ AAC 2 (G2)	[kN]	0,05
Aerated concrete	≥ AAC 4 (G4)	[kN]	0,25
Vertically perforated brick	≥ Hz 12 (ρ ≥ 0,9 kg/dm ³)	[kN]	0,13
Perforated sand-lime brick	≥ KSL 12 (ρ ≥ 1,6 kg/dm ³)	[kN]	0,40
Gypsum block	(ρ ≥ 0,9 kg/dm ³)	[kN]	0,10
Gypsum fibreboard	12,5 mm	[kN]	0,24
Gypsum plasterboard	12,5 mm	[kN]	0,12
Gypsum plasterboard	2 x 12,5 mm	[kN]	0,13
Mattone Forato Typ F8		[kN]	0,30
Tramezza Doppio UNI 19		[kN]	0,15
Sepa Parpaing		[kN]	0,30

¹ Required safety factors are considered.
² Valid for tensile load, shear load and oblique load under any angle.
³ Load determination on plastered wall.



Art. No.	Description	Max. Capacity
7805.052	Loop Hanger 1,0 mm - 1,5 mm	10 kg
7807.060	Suspension Bracket XPO Rail 1,2 mm	15 kg
7807.200	Steelwire + Slider 1,2 mm 300 Cm Black	15 kg
7807.210	Steelwire + Slider 1,2 mm 300 Cm Nickel	15 kg
7807.100	Ceiling Bracket Black C01BL	15 kg
7807.110	Ceiling Bracket Nickel C01NI	15 kg
7807.140	Ceiling Suspension 1,2 mm CS01NI	15 kg
7807.150	Ceiling Bracket Auto Grip 1,2 mm D01BL Black	15 kg
7807.160	Ceiling Bracket Auto Grip 1,2 mm D01NI Nickel	15 kg
7807.350	Steelwire 7 x 7 1,2 mm 10 m	15 kg
7807.360	Steelwire Black 7 x 7 1,2 mm 3 m	15 kg
7807.120	Recessed Ceiling Clip 24 mm White	5 kg
7807.121	Recessed Ceiling Clip 24 mm Black	5 kg
7807.125	Recessed Ceiling Clip Eco White	1 kg
7807.126	Recessed Ceiling Clip Eco Black	1 kg
7807.130	Recessed Ceiling Clip 20 mm + Suspension Auto Grip 1,2 mm	5 kg
7807.135	Drop Ceilinghanger	4 kg
7807.310	Steelwire + Hook 1,2 mm 300 Cm	15 kg
7807.010	Steelwire Hook Auto Grip 1,2 mm ST01BL	15 kg
7807.020	Steelwire Hook Auto Grip 1,2 mm ST01NI	15 kg
7807.030	Steelwire Hook Auto Grip 1,2 mm ST02NI	15 kg
7807.040	Steelwire Hook Auto Grip 1,2 mm ST03NI	15 kg
7807.050	Steelwire Clamphook Auto Grip 1,2 mm STC0NI	15 kg
7807.070	Steelwire Hook Auto Grip 1,2 mm STD01BL Black	15 kg
7807.080	Steelwire Hook Auto Grip 1,2 mm STD01NI Nickel	15 kg
7807.400	Acoustic Spring 01-NI	5 kg
7807.560	Drop Ceiling Clipphanger White	4 kg
7807.561	Drop Ceiling Clipphanger Black	4 kg
9.4404	Perlon 2 mm Coil 100 m	15 kg
9.4421s	Perlon 2 mm Coil 500 m	15 kg
9.4431	Wire Clamp 2 mm Alu	15 kg

PICTURE HANGING SYSTEMS

ALL-IN-ONE KITS









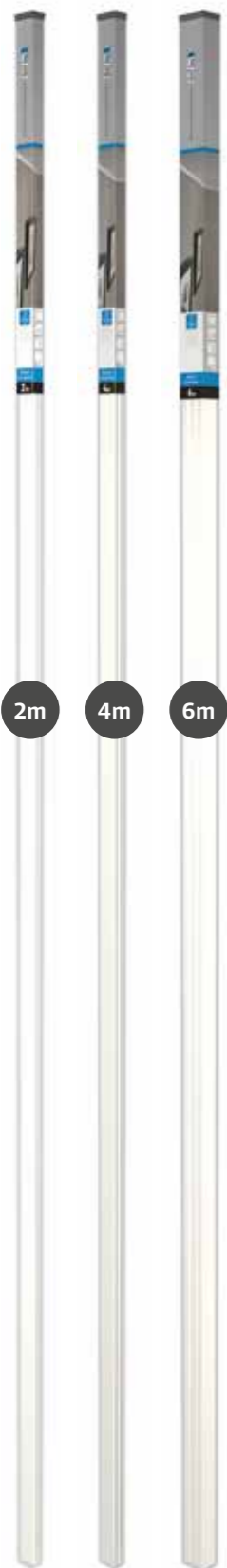









picture hanging systems - all-in-one kits

CLICK RAIL

The Click Rail flexible picture hanging system is available in a variety of all-in-one kits: economy, a Twister with a 15-kg hook and a Twister with a 20-kg Micro Grip hook. These retail packages contain the rail, mounting materials and instruction sheet, hanging wires and hooks, and are available in 2-m, 4-m and/or 6-m sets. The all-in-ones kits offer a complete solution and are ready for immediate onward sale.







ALL-IN-ONE CLICK RAIL ECONOMY

COMPLETE SET 2m					
ARTICLE NO.	9.5621	 1x 2m	 6x	 2x	 2x 150 cm max. 4 kg
		Click Rail White RAL 9010	Fastening Material	End Cap	Hook 4 kg + Slider Economy 2 mm Perlon
COMPLETE SET 2m					
ARTICLE NO.	9.5635	 1x 2m	 6x	 2x	 2x 150 cm max. 4 kg
		Click Rail Black Structured	Fastening Material	End Cap	Hook 4 kg + Slider Economy 2 mm Perlon
COMPLETE SET 4m					
ARTICLE NO.	9.5627	 2x 2m	 12x	 2x	 3x 150 cm max. 4 kg
		Click Rail White RAL 9010	Fastener Material	End Cap	Hook 4 kg + Slider Economy 2 mm Perlon
COMPLETE SET 6m					
ARTICLE NO.	9.5629	 3x 2m	 18x	 2x	 4x 150 cm max. 4 kg
		Click Rail White RAL 9010	Fastener Material	End Cap	Hook 4 kg + Slider Economy 2 mm Perlon

COMPLETE SET 2m

ARTICLE NO.	9.5623	 1x 2m	 6x	 2x	 2x 150 cm max. 4 kg
		Click Rail White Primer Ral 9016	Fastener Material	End Cap	Hook 4 kg + Slider Economy 2 mm Perlon

COMPLETE SET 4m

ARTICLE NO.	9.5628	 2x 2m	 12x	 2x	 3x 150 cm max. 4 kg
		Click Rail White Primer RAL 9016	Fastener Material	End Cap	Hook 4 kg + Slider Economy 2 mm Perlon

COMPLETE SET 6m

ARTICLE NO.	9.5630	 3x 2m	 18x	 2x	 4x 150 cm max. 4 kg
		Click Rail White Primer RAL 9016	Fastener Material	End Cap	Hook 4 kg + Slider Economy 2 mm Perlon

COMPLETE SET 2m

ARTICLE NO.	9.5622	 1x 2m	 6x	 2x	 2x 150 cm max. 4 kg
		Click Rail Alu Brushed	Fastener Material	End Cap	Hook 4 kg + Slider Economy 2 mm Perlon

picture hanging systems - all-in-one kits



CLICK RAIL

ALL-IN-ONE CLICK RAIL TWISTER 15 KG HOOK



COMPLETE SET 2m				
	 1x 2m	 6x	 2x	 2x 150 cm max. 15 kg
ARTICLE NO.	9.7162	Click Rail White Primer Ral 9016	Fastener Material	End Cap
				Hook 15 kg + Twister 2 mm Perlton





COMPLETE SET 2m				
	 1x 2m	 6x	 2x	 2x 150 cm max. 15 kg
ARTICLE NO.	9.7161	Click Rail White Ral 9010	Fastener Material	End Cap
				Hook 15 kg + Twister 2 mm Perlton

COMPLETE SET 2m				
	 1x 2m	 6x	 2x	 2x 150 cm max. 15 kg
ARTICLE NO.	9.7163	Click Rail Alu Brushed	Fastener Material	End Cap
				Hook 15 kg + Twister 2 mm Perlton

COMPLETE SET 2m				
	 1x 2m	 6x	 2x	 2x 150 cm max. 15 kg
ARTICLE NO.	9.7164	Click Rail Alu Brushed	Fastener Material	End Cap
				Hook 15 kg + Twister 2 mm Steelwire

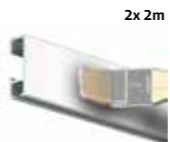
ALL-IN-ONE CLICK RAIL TWISTER MICRO GRIP 20 KG HOOK

COMPLETE SET 2m				
	 1x 2m	 6x	 2x	 2x 150 cm max. 20 kg
ARTICLE NO.	9.7130	Click Rail White Primer Ral 9016	Fastener Material	End Cap
				Micro Grip 2 mm + Twister 2 mm Perlton

COMPLETE SET 4m				
	 2x 2m	 12x	 2x	 3x 150 cm max. 20 kg
ARTICLE NO.	9.7131	Click Rail White Primer Ral 9016	Fastener Material	End Cap
				Micro Grip 2 mm + Twister 2 mm Perlton



SALES SUPPORT

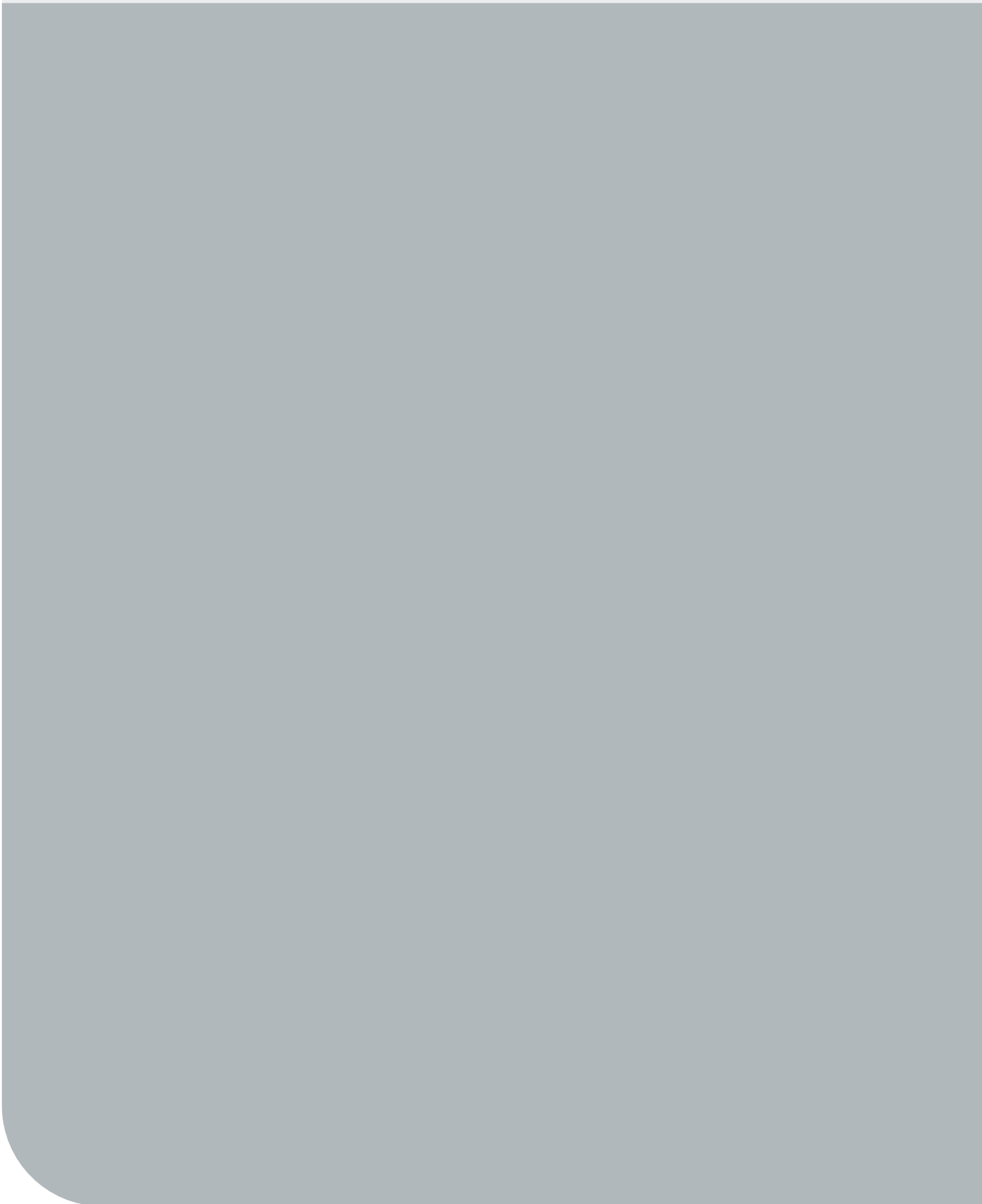

sales support

DISPLAYS & DEMONSTRATION TOOLS



DISPLAY ART HANGING SOLUTIONS XS		
3290C	Display AHS XS	50 x 34 x 212 cm

CONTENT DISPLAY ART HANGING SOLUTIONS XS	QUANTITY	
9.4348	Click Rail White Primer 200 cm	20
9.7051	End Cap White (2x)	6
9.7053	Corner Connector (2x)	6
9.7055	Click & Connect (6x) + Screws + Plugs	6
9.7058	Hook 15 kg (2x)	6
9.7075	Hook 4 kg (2x)	6
9.7076	Twister 2 mm Perlon 200 cm (2x)	12
9.7082	Hook 4 kg + Twister 2 mm Perlon 150 cm	6
9.7083	Hook 15 kg + Twister 2 mm Perlon 150 cm	12
9.7078	Micro Grip 2 mm (2x)	6
9.7079	Twister 2 mm Perlon 200cm + Micro Grip 2 mm	2
9.7162	All-In-One Kit Click Rail White Primer 200 cm	6
3290	Display	1

ACCESSOIRES RETAIL SETS



9.7051	End Cap White (2x)
9.7053	Corner Connector (2x)
9.7055	Click & Connect (6x) + Screws + Plugs
9.7058	Hook 15 kg (2x)
9.7075	Hook 4 kg (2x)
9.7076	Twister 2 mm Perlon 200 cm (2x)
9.7082	Hook 4 kg + Twister 2 mm Perlon 150 cm
9.7083	Hook 15 kg + Twister 2 mm Perlon 150 cm
9.7078	Micro Grip 2 mm (2x)
9.7079	Twister 2 mm Perlon 200cm + Micro Grip 2 mm

sales support

ALL-IN-ONE CLICK RAIL TWISTER 15 KG HOOK

RETAIL SETS

COMPLETE SET 2m

ARTICLE NO.	9.7162	1x 2m	6x	2x	150 cm 2x
		Click Rail White Primer RAL 9016	Fastener Material	End Cap	Hook 15 kg + Twister 2 mm Perlon

COMPLETE SET 2m

ARTICLE NO.	9.7161	1x 2m	6x	2x	150 cm 2x
		Click Rail White RAL 9010	Fastener Material	End Cap	Hook 15 kg + Twister 2 mm Perlon

COMPLETE SET 2m

ARTICLE NO.	9.7163	1x 2m	6x	2x	150 cm 2x
		Click Rail Alu Brushed	Fastener Material	End Cap	Hook 15 Kg + Twister 2 Mm Perlon

COMPLETE SET 2m

ARTICLE NO.	9.7164	1x 2m	6x	2x	150 cm 2x
		Click Rail Alu Brushed	Fastener Material	End Cap	Hook 15 kg + Twister 2 mm Steelwire

sales support

DISPLAYS & DEMONSTRATION TOOLS

SAMPLE BOX

45.90100	Sample Box Illume Duo Rail	55 x 35 x 4,5 cm
3246	Back Frame Hanging System	
3259	Sample Box Picture Hanging Systems	32 x 23 x 3 cm
7790.100	Sample Box Display It LED	56 x 43 x 6 cm
9010.180	Newly Sample Box complete 	32 x 23 x 3 cm
9010.190	Newly Sample Box R70 Museum Line 	32 x 23 x 3 cm
TS9550	Demo Frame Track & Slide	25 x 40 cm
TS9530	Sample Set Double Wall	16 x 25 cm
TS9540	Sample Set Heavy Duty Track	16 x 25 cm



DEMONSTRATION CASE

5038	Demonstration Case + Set 3 Inlays With Samples	58 x 40 x 12 cm
3244	Sign Hanging Systems	30 x 22 x 5 cm



BROCHURES

Article No.	Description	Article No.	Description
2740	Artiteq Product Catalogue NL	3746	Brochure Enjoy Life Love Living NL
2741	Artiteq Product Catalogue EN	3747	Brochure Enjoy Life Love Living EN
		3748	Brochure Enjoy Life Love Living FR
2490	Brochure For Schools NL	3450	Brochure Enjoy Life Love Living DE
2491	Brochure For Schools EN		
		2725	Brochure Display It Led NL
2494	Brochure Integrated Systems NL	2726	Brochure Display It Led EN
2495	Brochure Integrated Systems EN		
		1059	Mini Catalogue
2685	Brochure Back Frame Hanging System NL		
2686	Brochure Back Frame Hanging System EN	2700	Brochure Artiteq Sign Hanging Systems NL
		2701	Brochure Artiteq Sign Hanging Systems EN
2912	Housing Construction NL		
2926	Housing Construction EN	2913	Musea brochure NL
		2929	Musea brochure EN
2909	Healthcare brochure NL		
2923	Healthcare brochure EN	2920	Dibond Flyer EN
		2947	Brochure Illume Duo Rail NL
		2946	Brochure Illume Duo Rail EN



DESK DISPLAY R35 RAIL LED

9010.215	Desk Display R35 Rail LED
----------	---------------------------

ARTITEQ ONLINE

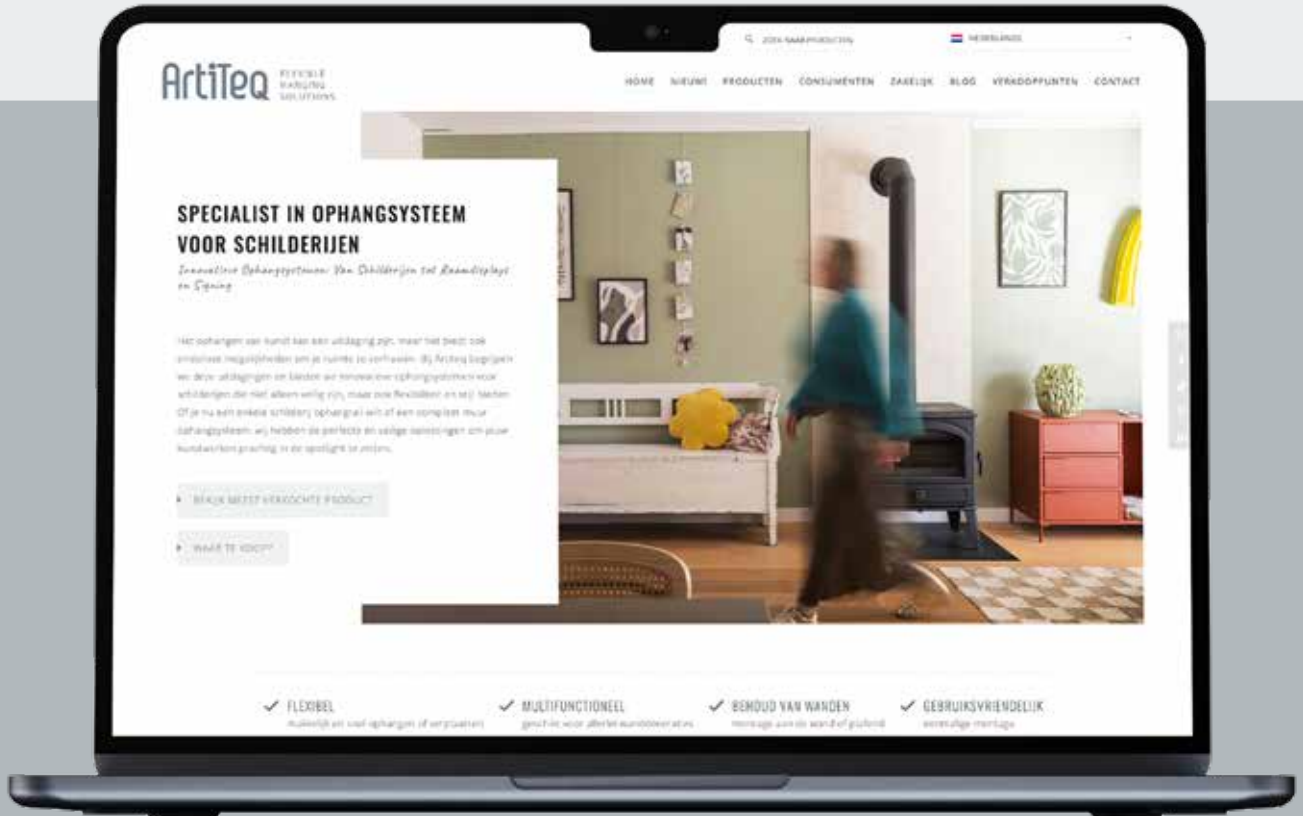

FIND OUR PRODUCTS AND INFORMATION ON OUR WEBSITE!

- Our range of products can almost all be found on our website www.artiteq.com
- The products are divided into 3 segments: Picture hanging systems, Display hanging systems and Sign hanging systems.
- Are you looking for technical information, product sheets, brochures or installation instructions? These can all be found on the product page itself of the respective product.
- For inspiration, tips and market related stories and more visit www.artiteq.com/blog



to our website



to our blogs

This product catalogue has been produced with the utmost care and attention. Nevertheless, misprints and printing errors may occur. Artiteq cannot be held liable for any such errors. Product specifications, colours, dimensions and availability may change without prior notice. No rights can be derived from the information contained in this catalogue.

